

**MÜLLER** *TOOL INNOVATOR*  
**Germany** **WERKZEUG**<sup>®</sup>

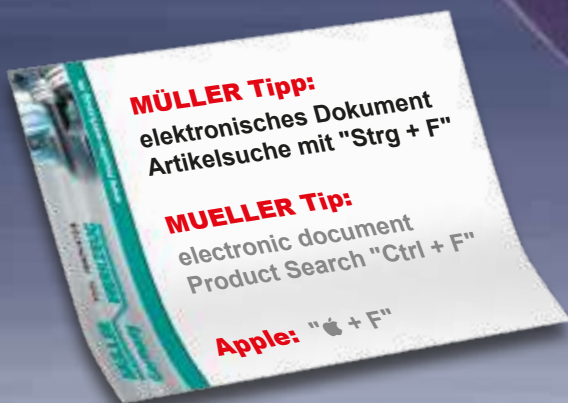

**We innovate tools!**





**1**



**2**



**3**



**4**

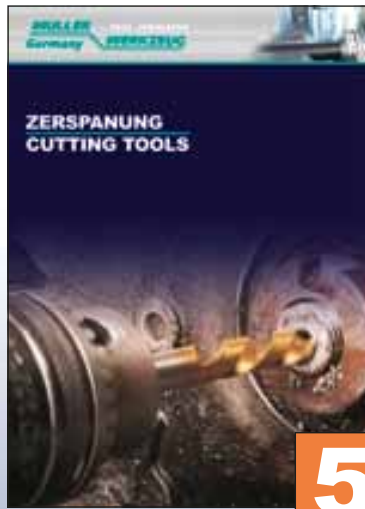

**5**



**6**



**7**

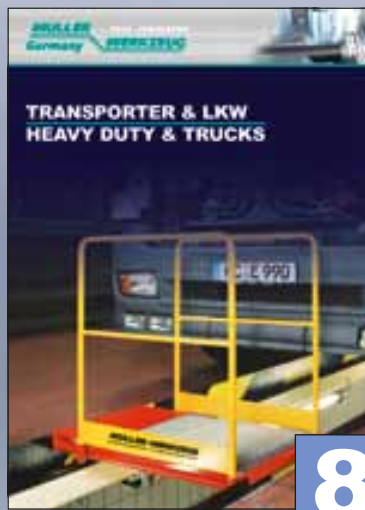

**8**

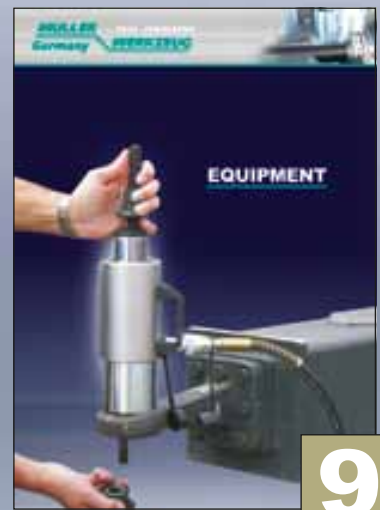

**9**

# Neuheiten



**Stahl-Druckluftkupplungen Eurostandard**  
**Steel Couplings**

Seite / page 1-28



**Klebegewichtzange**  
**Wheel Weight Plier**

Seite / page 3-04

**Mini-Ratschen Rohrabschneider**  
**Mini-ratchet pipe cutter**

Seite / page 3-24



**Felgen-Radierscheibe**  
**Conical eraser for rims**

Seite / page 3-07



**Bremsscheiben**  
**Schieblehre digital**  
**Brake Disc Caliper Digital**

Seite / page 3-17

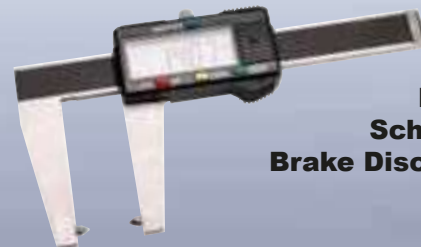

**Bremslinien-Richtwerkzeug**  
**Brake line straightener**

Seite / page 3-25



**Radnabenschleifer Typ 1,**  
**1/2" Antrieb**  
**Wheel Hub Grinder Type 1,**  
**1/2" drive**

Seite / page 3-09

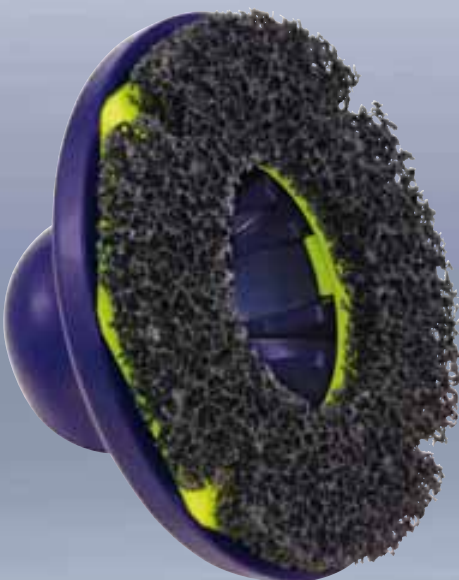

Druckluft-Werkzeuge  
 Power Tools  
 1  
 Fahrwerk  
 Suspension  
 2  
 Bremse & Rad  
 Brake & Wheel  
 3  
 Motor  
 Engine-Tools  
 4  
 Zerschneidung  
 Cutting Tools  
 5  
 Karosserie/Verschleiß  
 AutoBody/Consumables  
 6  
 Universal-Werkzeuge  
 Universal Tools  
 7  
 Transporter & LKW  
 Heavy Duty & Trucks  
 8  
 Equipment  
 9  
 Inhaltsverzeichnis  
 Table of Contents

# News



**Schlauchschellen-Zangen**  
**Hose clamp plier**  
Seite / page 4-03

**LED-Duo**  
**Werkstattlampe**  
**LED-DUO Lamp**  
Seite / page 7-26



**Glühspitzen-Ausbohrersatz**  
**universal**  
**Complete kit for glow plugs**  
**electrode extraction**  
Seite / page 4-20



**Uni-Injektor-Ausziehsatz**  
**Uni Injector puller kit**  
Seite / page 4-20



**Hartmetallbohrer Satz**  
**Carbide tip drills kit**  
Seite / page 5-11



**Mini**  
**Lamellenscheiben**  
**Mini flap disc**  
Seite / page 5-05



**Klingen-Schaber**  
**Razor Scraper**  
Seite / page 6-10



**Zugmesser-Satz, 3tlg.**  
**Pro-Xknife kit, 3pcs**  
Seite / page 6-11



**MUELLER-KUEPS  
 Bierkrug / Beer Mug**  
 made in Germany  
**Nr. M906 016**



**MUELLER-KUEPS  
 Küchen-Messer / Cooking Knife**  
 made in Germany  
**Nr. 906 015**

**MUELLER-KUEPS Tasche / Bag**  
**Nr. EQ-114/K**  
 Size: 12" x 8.5" x 2.5"



**MEN'S OKAPI KNIT JACKET**

- Nr. 1817-995-3-M**      Size: M
- Nr. 18117-995-4-L/G**      Size: L
- Nr. 18117-995-5-XL/TG**      Size: XL
- Nr. 18117-995-6-2XL**      Size: XXL

**MUELLER-KUEPS  
 Baseball-Cap**  
**Nr. M906 017**



**Magnetschalen-Satz, 2-teilig, darkblue**  
**Magnetic Parts Bowl, 2 pcs., darkblue**  
**Nr. 905 007/darkblue**



# POWER TOOLS

DER MAßSTAB FÜR  
**KRAFT!**



**MÜLLER Tipp:**  
elektronisches Dokument  
Artikelsuche mit "Strg + F"

**MUELLER Tip:**  
electronic document  
Product Search "Ctrl + F"

**Apple:** "⌘ + F"

Druckluft-Werkzeuge  
Power Tools 1

Fairwerk  
Suspension 2

Bremse & Rad  
Brake & Wheel 3

Motor  
Engine-Tools 4

Zerspanung  
Cutting Tools 5

Karosserie/Aerschleiß  
AutoBody/Consumables 6

Universal-Werkzeuge  
Universal Tools 7

Transporter & LKW  
Heavy Duty & Trucks 8

Equipment 9

Inhaltsverzeichnis  
Table of Contents

## AKKU-SCHLAGSCHRAUBER 1/4" CORDLESS IMPACT GUN 1/4"

MÜLLER-WERKZEUG Technische Daten / technical information		
Gewicht / weight	Kg	0,9
Länge / length	mm	150
Höhe / height	mm	190
Losbrechmoment / breakaway torque	Nm	80
Batterie / Battery		12V 2Ah
Ladedauer / charging time	min.	30



Neueste Li-Ion Akku-Technologie  
latest Li-Ion technology



**Kleinste mögliche Bauweise - ideal für schwer erreichbare Stellen.** Leichter 1/4" Akku-Schlagschrauber. Schnelllader, Einhandbedienung mit stufenlosem Abzug. Inkl. LED-Licht.  
Batterie: 12V Li-Ion. Ladedauer: 30 min.

**Nr. EQ-113 Akku-Schlagschrauber 1/4"**

Code: OE198000198



**Perfect for hard to reach areas.** Very powerful 1/4" Impact Wrench. Max. torque: 80 Nm. Ergonomic handle. Variable speed trigger. Incl. LED-Light. Battery 12V 2Ah. Recharging time: 30 min.

**Cordless Impact Gun 1/4"**

## MÜLLER 114 AKKU SCHLAGSCHRAUBER 1/2" MUELLER 114 CORDLESS IMPACT GUN 1/2"

WE SET THE STANDARD  
FOR **TORQUE!**



Losbrechmoment:  
Breakaway-Torque:  
**982 Nm**

DER MAßSTAB FÜR  
**KRAFT!**



**Ergonomisch  
angepasster Griff**  
Ergonomic handle

**Stufenlose Drehzahlregelung**  
Variable speed trigger

**MÜLLER  
114**



**Ultimative Leistung!** Sehr kraftvoller 1/2" Akku-Schlagschrauber. Rechts- / Links-Umschaltung mit nur einer Hand. Ergonomisch perfekt angepasster Griff. Neuartiger Abzug mit stufenloser Drehzahlregelung. Maximales Losbrechmoment: 982 Nm. Batterie: 18V 3.0Ah. Sehr geringe Ladedauer: 45 min.

**Nr. EQ-114 Müller 114  
Akku Schlagschrauber 1/2"**

Code: OE428000428



**Ultimate Power!** Very strong 1/2" impact wrench. Ergonomic handle. One hand forward / reverse switch. Variable speed trigger. Breakaway torque: 982 Nm. Battery: 18V 3.0Ah. Short charging time: 45min.

**Mueller 114 cordless Impact Gun 1/2"**



## SCHWEISSPUNKT-LÖSER AIR SPOTWELDING DRILL

**Nr. 404 108**

Code: OE128001280

8 x 44 mm

**Nr. 404 408**

Code: OE160000016



**Nr. 222 308**

Code: OE490000049

**Punktschweißfräser 8,0 x 44 mm.  
Passend für EQ-401 001.**

Carbide spot weld drill bit 8,0 x 44 mm.  
Fits the EQ-401 001.

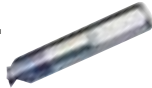

**Zum Lösen der Schweißpunkte an Karosserieblechen.**

Mit entsprechenden Bohrern auch für hochfeste Bleche geeignet. Bohrtiefe stufenlos einstellbar. Gegenhaltebügel drehbar und abnehmbar, somit auch für schwer zugängliche Stellen geeignet.

**Nr. EQ-401 001 Schweißpunkt-Löser**

Code: OE598000598



**The Tool to use for drilling High Strength Steel!**

Operates at 1200rpm or less. Drill bits will last longer. Use for removing spot welds on all flanges. Comes with removable "G-clamp". Adjustable depth to ensure there is no drilling in second panel. To extend the life of the drill bit, use the center punch and the special cutting oil.

**Air spotwelding drill**

## SCHWEISSPUNKT-LÖSER AIR SPOTWELDING DRILL



**Hochleistungs-Schweißpunkt-Fräsmaschine** zum Lösen der Schweißpunkte an Karosserieblechen. Auch geeignet für hochfeste Karosseriebleche. Klemmbügel verstellbar, somit auch Arbeiten an schwer zugänglichen Positionen möglich. (Bodenblech, Heckraum etc.)

**Nr. EQ-404 Schweißpunkt-Löser**

Code: OE598000598



**Professional pneumatically driven spotwelding** milling machine. The machine enables you to remove all spot welds from the body work. The machine's clamping bracket is adjustable to the left or the right. That generates works e.g. spot welds at a bottom plate.

**Nr. EQ-404 Air spotwelding drill**

Code: OE598000598



**Verstellbarer Klemmbügel**  
Clamping bracket is adjustable

MÜLLER-WERKZEUG Technische Daten / technical information	
Antrieb / drive	mm 8,0
Gewicht / weight	Kg 1,8
Max. Bohrtiefe / stroke length	mm 68
Anschlussgewinde / air nipple	Zoll 1/4"
Schlauchanschluss / air hose	mm 9-13
Luftverbrauch / air consumption	l/min 350
Drehzahl/min / free speed	Rpm 25000
Arbeitsdruck / air pressure	bar 6,2
Geräuschpegel / sound level	dBA 71



**Nr. 404 080**  
Code: OE122001220

**Nr. 404 008**  
Code: OE151001510

## UNIVERSAL REINIGUNGSSET FÜR KONTAKTFLÄCHEN AIR ANGLE GRINDER KIT



Nr. 111 812

**optional**  
**Mini Lamellenscheiben**  
Ø 50mm, 10er Pack  
Mini flap disc Ø 50mm, 10pack

**Nr. 111 550/K40 Körnung K40**  
Code: OE290000029 grid K40

**Nr. 111 550/K60 Körnung K60**  
Code: OE290000029 grid K60

**Nr. 111 550/K80 Körnung K80**  
Code: OE290000029 grid K80

MÜLLER-WERKZEUG Technische Daten / technical information		
Gewicht / weight	Kg	0,50
Länge / length	mm	120
Anschlussgewinde / air nipple	Zoll	1/4"
Schlauchanschluss / air hose	mm	9-13
Luftverbrauch / air consumption	l/min	250
Drehzahl/min / rpm	Rpm	15000
Arbeitsdruck / air pressure	bar	6,2
Geräuschpegel / sound level	dBA	85



Nr. 111 816  
Code: OE128000128

**2-stufig,**  
**8.000 / 15.000 U/min**  
2-steps,  
8.000 / 15.000 RPM



### Einzelteile / spare parts:

**grobe Körnung**  
rough grain



Nr. 111 050  
Code: OE2900000290

**extra grobe Körnung**  
extra rough grain



Nr. 111 050/PUR  
Code: OE3900000390

**feine Körnung**  
fine grain



Nr. 111 360  
Code: OE980000980

**mittlere Körnung**  
medium grain



Nr. 111 350  
Code: OE980000980

**grobe Körnung**  
rough grain



Nr. 111 350/PUR  
Code: OE980000980



**Ergonomischer Winkelschleifer, 2-stufig.** Optimale Handhabung durch 70° Winkelstellung. 2-stufig, 8.000 / 15.000U/min. Schnellwechselschleifteller Ø 50mm. Passend für Roloc-System zum Schleifen, Entgraten, Polieren und Finishen. Zum Beispiel für Radnaben etc. 16-tlg.

**Ergonomic angle grinder.** 70° angle head for optimized use. 2-step, 8000 / 15.000RPM. Quick-change pad Ø 50mm. Fits for Roloc-system sanding pad. Max speed: 15.000RPM. 16 pcs. kit.

**Nr. 111 812 Universal Reinigungsset für Kontaktflächen, 16-tlg.**  
Code: OE198000198

**Air Angle Grinder Kit, 16 pcs.**

Druckluft-Werkzeuge Power Tools  
1  
Fahrwerk Suspension  
2  
Bremsse & Rad Brake & Wheel  
3  
Motor Engine-Tools  
4  
Zerspanung Cutting Tools  
5  
Karosserie/Verschleiß AutoBody/Consumables  
6  
Universal-Werkzeuge Universal Tools  
7  
Transporter & LKW Heavy Duty & Trucks  
8  
Equipment  
9  
Inhaltsverzeichnis Table of Contents

## MÜLLER DRUCKLUFTSÄGE MUELLER AIR SAW



Durch die sehr hohe Hubzahl perfekt für Bleche und Dünobleche 0,4-3mm z. B. bei Karosseriearbeiten. Auch für Kunststoffe, Fiberglas, Kompositmaterial etc. geeignet. Sehr ruhiger und vibrationsarmer Lauf. Temperaturisolierter Griff. Auspuff nach hinten.

### Nr. 290 113 MÜLLER Druckluftsäge

Code: OE298000298



Based on the high speed stroke this tool is ideal for steel sheets 0,4 to - 3 mm, works as well for plastics, fiberglass, composites etc. Smooth cutting action. Comfort temperature insulated grip handle. Low vibration (2.99 m/s<sup>2</sup>) Smooth trigger with safety lever for easy operation. Rear exhaust.

### Nr. 290 113 MUELLER air saw

Code: OE298000298



MÜLLER-WERKZEUG Technische Daten / technical information		Nr. 290 113	Nr. 290 114
Länge / length	mm	238	270
Hub / stroke-length	mm	10	10
Anschlussgewinde / air nipple	Zoll	1/4"	1/4"
Schlauchanschluss / air hose	mm	9-13	9-13
Luftverbrauch / air consumption	l/min	250	250
Hub/min / free speed	Bpm	<b>9.800</b>	<b>7.500</b>
Arbeitsdruck / air pressure	bar	6,3	6,2
Gewicht / weight	Kg	0,69	0,90



## MÜLLER114 GETRIEBE-DRUCKLUFTSÄGE MUELLER114 GEAR TRANSMITTED AIR SAW



**MÜLLER  
114**



**MÜLLER 114 Getriebe-Druckluftsäge** mit völlig neuartigem Design. Extrem kraftvoll und sehr geringes Gewicht. Ergonomisch angepasster Griff. Abluftgeräusch gedämmt nach vorne. Ideal für Arbeiten an schwer erreichbaren Stellen.

### Nr. 290 114 MÜLLER 114 Getriebe-Druckluftsäge

Code: OE398000398



This new gear transmitted air saw cuts **deeper** and more powerful as any competition. The front exhaust technology provides increased performance. Small size allows for great access into tight work areas. Rotable exhaust ring between housing and head.

### MUELLER 114 Gear transmitted air saw

## Ersatz-Sägeblätter, 20 Stk. / Saw-blades, 20 pcs.

passend für MÜLLER-Druckluftsägen Nr. 290 113 und Nr. 290 114.  
fits for MUELLER air saws



**Nr. 235 014** Code: OE40404040  
Sägeblätter / Saw-blades **Z-14**

**Nr. 235 011** Code: OE40404040  
Sägeblätter / Saw-blades **Z-24**

**Nr. 235 004** Code: OE40404040  
Sägeblätter / Saw-blades **Z-14**

**Nr. 235 002** Code: OE40404040  
Sägeblätter / Saw-blades **Z-24**

**Nr. 235 018** Code: OE40404040  
Sägeblätter / Saw-blades **Z-18**

**Nr. 235 010** Code: OE40404040  
Sägeblätter / Saw-blades **Z-32**

**Nr. 235 005** Code: OE40404040  
Sägeblätter / Saw-blades **Z-18**

**Nr. 235 003** Code: OE40404040  
Sägeblätter / Saw-blades **Z-32**

passend für PLF80/90:  
fits for PLF80/90:



## DL-BANDSCHLEIFER AIR BELT GRINDER



**Schleifband Breite: 10mm x 330mm**  
Belt width: 10mm x 330mm

MÜLLER-WERKZEUG Technische Daten / technical information		
<b>Gewicht / weight</b>	kg	0,90
<b>Länge / length</b>	mm	315
<b>Anschlussgewinde / air nipple</b>	Zoll	1/4"
<b>Schlauchanschluss / air hose</b>	mm	9-13
<b>Luftverbrauch / air consumption</b>	l/min	85
<b>Drehzahl/min / rpm</b>	Rpm	25.000
<b>Arbeitsdruck / air pressure</b>	bar	6,3
<b>Geräuschpegel / sound level</b>	dB	82



**Universell einsetzbare Druckluftmaschine z. B. für Schweißnähte,** Punktschweißungen, Hartlötstellen, Entrosten, Entgraten etc. in Karosseriebau, Lackiererei, PKW-Werkstatt, LKW-Werkstatt, Industrie. Durch drehbaren Handgriff auch an verwinkelten, schwer zugänglichen Stellen einsetzbar.

### Nr. 290 165 DL-Bandschleifer Code: OE198000198 komplett mit 15 Schleifbändern

Nr. 290 040 Code: OE580000058	Ersatzschleifband K-40 (VPE 25 Stück), braun
Nr. 290 060 Code: OE580000058	Ersatzschleifband K-60 (VPE 25 Stück), braun
Nr. 290 080 Code: OE580000058	Ersatzschleifband K-80 (VPE 25 Stück), braun
Nr. 290 120 Code: OE640000064	Ersatzschleifband K-120 (VPE 25 Stück), braun
Nr. 290 041 Code: OE590000059	Spezialschleifband K-40 (VPE 25 Stück), grün
Nr. 290 061 Code: OE590000059	Spezialschleifband K-60 (VPE 25 Stück), grün
Nr. 290 081 Code: OE590000059	Spezialschleifband K-80 (VPE 25 Stück), grün
Nr. 290 121 Code: OE680000068	Spezialschleifband K-120 (VPE 25 Stück), grün



**Universal use for welding seams, spot welds,** soldered connections, rust, de-burring at body shops, truck shops, paint shops, industry. Swivelling belt finger for narrow spaces.

### Air Belt Grinder complete with 15 belts

Replacement belt K-40 (package 25 pcs.), brown
Replacement belt K-60 (package 25 pcs.), brown
Replacement belt K-80 (package 25 pcs.), brown
Replacement belt K-120 (package 25 pcs.), brown
Special belt K-40 (package 25 pcs.), green
Special belt K-60 (package 25 pcs.), green
Special belt K-80 (package 25 pcs.), green
Special belt K-120 (package 25 pcs.), green

## VIBRO-IMPACT® SYSTEM

**Schnellwechselfutter**  
Quick-chuck

**Rückschlagdämpfung**  
Spring vibration dampening

**Ergonomisches Design**  
Ergonomic design

**stufenloser Abzug**  
Variable speed trigger

**Nr. 290 206**

<b>MÜLLER-WERKZEUG</b> Technische Daten / technical information		
<b>Antrieb / drive</b>	mm	10,2
<b>Gewicht / weight</b>	Kg	2,49
<b>Länge / length</b>	mm	292
<b>Anschlussgewinde / air nipple</b>	zoll	1/4"
<b>Schlauchanschluss / air hose</b>	mm	9-13
<b>Luftverbrauch / air consumption</b>	l/min	114
<b>Schläge/min / impacts/min</b>	Bpm	2200
<b>Arbeitsdruck / air pressure</b>	bar	6,2
<b>Geräuschpegel / sound level</b>	dBA	100

## VIBRO-IMPACT®



**Nr. 290 210**  
Code: OE290000029



**Nr. 290 220**  
Code: OE290000029



**Nr. 290 230**  
Code: OE460000046



**Nr. 290 241**  
Code: OE390000039



**VIBRO-IMPACT®** System-Werkzeug zum Lösen festsitzender Verbindungen. Der punktgenaue Schlag des extrem kräftigen Pressluft-Hammers hilft bei der Demontage von z.B. Kegelsitzverbindungen, Radlagern, Buchsen, festgerosteten Schraubverbindungen und wirkt unterstützend z.B. von Abzieh- und Silentwerkzeugen.

**Nr. 290 206 VIBRO-IMPACT® SYSTEM**  
Code: OE338000338



**VIBRO-IMPACT®** System-tool to loose tight connections. The high performance air hammer helps to disassemble e.g. conical seat connections, wheel bearings, bushes, rusted screw connections...

**VIBRO-IMPACT® SYSTEM**

**VIBRO-IMPACT® MEIßEL**  
**VIBRO-IMPACT® CHISELS**

**VIBRO-IMPACT®**

**Kugelführung, Verdrehsicherung**  
Ball-guide, non-turn

**Aufnahme: 10,2mm**  
Shaft: 10,2mm



**VIBRO-IMPACT® Meißel**, verdrehsicher. In drei verschiedenen Ausführungen erhältlich: Karosserie-Trenn-Meißel, Flachmeißel und Halbrundmeißel. Aufnahme: 10,2mm.

**Nr. 290 217 VIBRO-IMPACT® Blech-Trenn-Meißel**  
Code: OE410000041

**Nr. 290 218 VIBRO-IMPACT® Flach-Meißel**  
Code: OE410000041

**Nr. 290 219 VIBRO-IMPACT® Halbrund-Meißel**  
Code: OE410000041



**VIBRO-IMPACT® Chisel**, non turnable. Three different constructions: Sheet metal cutter, flat chisel and half round chisel. Shaft: 10,2mm

**VIBRO-IMPACT® sheet metal cutter**

**VIBRO-IMPACT® chisel separator**

**VIBRO-IMPACT® half round**

**Nr. 290 214 VIBRO-IMPACT® Austreiber 6,5mm**  
Code: OE430000043  
**VIBRO-IMPACT® pin 6.5mm**

**Nr. 290 236** Austreiber 8mm geschmiedet mit Zentrierkopf  
Code: OE380000038  
Pin driver 8mm, drop forged, center head

**Nr. 290 237** Austreiber 10mm geschmiedet mit Zentrierkopf  
Code: OE380000038  
Pin driver 10mm, drop forged, center head

**Nr. 290 238** Austreiber 12mm geschmiedet mit Zentrierkopf  
Code: OE380000038  
Pin driver 12mm, drop forged, center head

**Nr. 290 239** Austreiber 12mm geschmiedet, Zylinderform  
Code: OE240000024  
Pin driver 12mm, drop forged, cylinder head

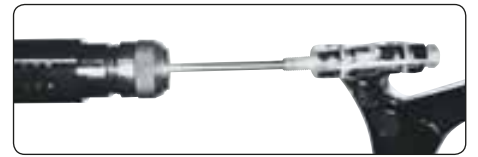

**Zum Trennen des inneren Auspuffrohres**  
To cut the inner tube



**Zum Trennen des äußeren Auspuffrohres**  
To cut the outside tube



**VIBRO-IMPACT® Auspuffmeißel-Satz, 2-tlg.**  
Zur Verwendung mit dem Druckluft-Hammer.

**Nr. 403 120 VIBRO-IMPACT® Auspuffmeißel**  
Code: OE840000084



**VIBRO-IMPACT® exhaust chisel set, 2pcs.**  
For use with the air hammer.

**VIBRO-IMPACT® exhaust chisel**

**KONKAV-AUSTREIBER**  
**CONCAVE HAMMER INSERT**



Schrauben und Bolzen werden durch die konkave Form perfekt zentriert. Länge 150mm.

**Nr. 290 231 Konkav-Austreiber**  
Code: OE360000036



Bolts and pins will be perfect centered through concave shape. Length 150mm.

**Concave hammer insert**



## VIBRO-IMPACT® SPURSTANGEN-GABEL VIBRO-IMPACT® FORK CHISEL

**Geschmiedet aus einem Stück**  
drop forged



32 mm



**VIBRO-IMPACT®** Spurstangen-Gabel zum Lösen festsitzender Spurstangen und Kegelsitzverbindungen. Passend für MÜLLER Drucklufthammer, Nr. 290 200. Aus einem Stück geschmiedet. (keine Schraubverbindung am Werkzeug)

**VIBRO-IMPACT®** fork chisel to loose tight conical seat-connections. Fits for MUELLER Air Hammer, no. 290 200. Drop forged.

**Nr. 290 226 VIBRO-IMPACT® Spurstangengabel 20mm**  
Code: OE64000064

**VIBRO-IMPACT® Fork Chisel 20mm**

**Nr. 290 227 VIBRO-IMPACT® Spurstangengabel 25mm**  
Code: OE68000068

**VIBRO-IMPACT® Fork Chisel 25mm**

**Nr. 290 228 VIBRO-IMPACT® Spurstangengabel 32mm**  
Code: OE78000078

**VIBRO-IMPACT® Fork Chisel 32mm**

## VIBRO-IMPACT® NADELENTROSTER VIBRO-IMPACT® NEEDLE SCALER

### VIBRO-IMPACT®



Kombi-Aufsatz für MÜLLER Drucklufthammer zur Entrostung und Farbentfernung.

**Nr. 290 245 VIBRO-IMPACT® Nadelentroster**  
Code: OE88000088



Additional unit to MUELLER Air Hammer for rust and paint removal.

**VIBRO-IMPACT® Needle Scaler**



## VIBRO-IMPACT® VERSCHRAUBUNGS-LÖSEWERKZEUG THREADED FASTENER / JOINT RELEASE TOOL



**Schnelles Lösen auch stark verrosteter Muttern** z. B. Spurstangen, Konterverschraubungen, Verschraubungen an Achskörpern usw. 190 mm lang. Bis max. SW22.

**Nr. 290 250 VIBRO-IMPACT® Verschraubungs-Lösewerkzeug**  
Code: OE168000168



**Quick release of heavily corroded nuts** e. g. on steering rods and bolted connections on axle bodies, etc. 190 mm long. Max. 22mm.

**Nr. 290 250 VIBRO-IMPACT® Threaded Fastener / Joint Release Tool**  
Code: OE168000168

**hochwertige Ausführung**  
quality design

**ergonomischer Handgriff**  
ergonomic handle



## XL-VIBRO-IMPACT® DRUCKLUFTHAMMER HEAVY DUTY VIBRO-IMPACT® AIR HAMMER



Der punktgenaue Schlag des extrem kräftigen Pressluft-Hammers hilft bei der Demontage von z. B. Kegelsitzverbindungen, Radlagern, Buchsen, festgerosteten Schraubverbindungen und wirkt unterstützend z. B. von Abzieh- und Silentwerkzeugen.

### Nr. 290 300 XL-VIBRO-IMPACT® Drucklufthammer

Code: OE698000698



Heavy duty VIBRO-IMPACT® air hammer to loose tight connections at trucks, agricultural, construction etc. The high performance air hammer helps to disassemble e. g. conical seat connections, wheel bearings, bushes, rusted screw connections. Can support as well pullers.

### Nr. 290 300 Heavy Duty VIBRO-IMPACT® Air Hammer

Code: OE698000698

MÜLLER-WERKZEUG Technische Daten / technical information		
Antrieb / drive	mm	15mm 6-Kant / HEX
Gewicht / weight	Kg	5,40
Länge / length	mm	380
Anschlussgewinde / air nipple	Zoll	3/8"
Schlauchanschluss / air hose		13 mm / 1/2"
Luftverbrauch / air consumption	l/min	210
Schläge/min / impacts/min	BPM	2.500
Arbeitsdruck / air pressure	bar	6,2



Nr. 290 318

Nr. 290 338



Nr. 290 310

Nr. 290 320

Nr. 290 331

- Nr. 290 318 XL-VIBRO-IMPACT® Flachmeißel, 6-kant Schaft  
Code: OE698000068 Heavy Duty VIBRO-IMPACT® flat chisel
- Nr. 290 338 XL-VIBRO-IMPACT® Austreiber 20mm, 6-kant Schaft  
Code: OE698000068 Heavy Duty VIBRO-IMPACT® pin driver 20mm
- Nr. 290 310 XL-VIBRO-IMPACT® Spurstangen, 6-kant Schaft  
Code: OE124000124 Heavy Duty VIBRO-IMPACT® tie rod
- Nr. 290 320 XL-VIBRO-IMPACT® Hammer 6-kant Schaft  
Code: OE124000124 Heavy Duty VIBRO-IMPACT® hammer
- Nr. 290 331 XL-VIBRO-IMPACT® Konkav 6-kant Schaft  
Code: OE124000124 Heavy Duty VIBRO-IMPACT® concave

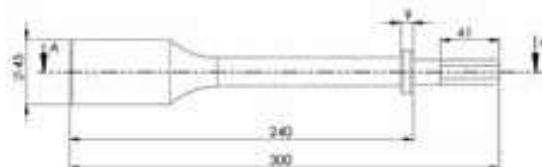

Druckluft-Werkzeuge  
Power Tools  
1  
Fahrwerk  
Suspension  
2  
Bremse & Rad  
Brake & Wheel  
3  
Motor  
Engine-Tools  
4  
Zerspanung  
Cutting Tools  
5  
Karosserie/Verschleiß  
AutoBody/Consumables  
6  
Universal-Werkzeuge  
Universal Tools  
7  
Transporter & LKW  
Heavy Duty & Trucks  
8  
Equipment  
9  
Inhaltsverzeichnis  
Table of Contents





**2-Komponenten Kunststoffgehäuse**  
2-component housing

**Stufenloser Abzug**  
Variable speed

**Ergonomischer Griff**  
Ergonomic handle



**Industrie-Druckluftbohrmaschine** mit 2-Komponenten Kunststoffgehäuse. Abluftgeräusch gedämmt nach unten, verstellbarer zusätzlicher Handgriff, Rechts-Links Umschaltung mit einer Hand.

**Nr. 290 432 Druckluft-Bohrmaschine 500 U/min**  
Code: OE248000248

Nr. 290 433 Druckluft-Bohrmaschine 1.800 U/min  
Code: OE198000198



**Nr. 290 433**  
1.800 U/min / rpm



**Cool insulated** based on 2-component housing. Soft handle. Exhaust downside, left / right switch. Could be used for grinding and drilling.

**Air drill 500 rpm**

Air drill 1.800 rpm

## DRUCKLUFT-BOHRMASCHINE AIR DRILL

**Leistungs- und drehmomentstark**  
speziell für Radnabenschleifer

Power and high torque especially for hub grinder

**Erhältlich mit 500 U/min oder 1.800 U/min**  
Available in 500 rpm and 1.800 rpm

MÜLLER-WERKZEUG Technische Daten / technical information		
	290 432	290 433
Bohrfutter / drive	Zoll	3/8"
Gewicht / weight	Kg	1,75 1,25
Länge / length	mm	230 200
Anschlussgewinde / air nipple	Zoll	1/4"
Schlauchanschluss / air hose	mm	9-13
Luftverbrauch / air consumption	l/min	200 220
Drehzahl/min / rpm	Rpm	500 1.800
Arbeitsdruck / air pressure	bar	6,2
Geräuschpegel / sound level	dBA	80



## DRUCKLUFT-WINKELBOHRMASCHINE RECHTS- + LINKSLAUF AIR ANGLE DRILL LEFT + RIGHT SWITCH



**Universelle Anwendung** an schwer zugänglichen Stellen. Rechts- und Linkslauf. Stufenloser Abzug. Ideal für Arbeiten mit sehr niedriger Drehzahl-Voraussetzung (z. B. Glühkerzen ausbohren). Präzisions-Bohrfutter von 0 bis 10mm. Auch als Antrieb für Schleifscheiben geeignet.

**Nr. 290 444 Druckluft-Winkelbohrmaschine**  
Code: OE238000238  
Rechts- + Linkslauf.  
Stufenlose Drehzahlreglung.



**Universal use** on narrow space areas. Ergonomic handle. Variable speed. Left / right switch. Cool insulated based on 2-component housing. Fits also for grinding discs. Drill chuck 0-10mm included.

**Nr. 290 444 Air angle drill**  
Code: OE238000238  
left + right switch



**Rechts- / Linksumschaltung**  
und **stufenloser Drehzahlregler**  
Left + right switch plus variable speed

**Stufenloser Abzug ermöglicht die Arbeit mit sehr geringer Drehzahl.**  
Variable speed trigger provides to work on low-rotation speed.

MÜLLER-WERKZEUG Technische Daten / technical information		
Bohrfutter / drive	Zoll	3/8"
Gewicht / weight	Kg	1,20
Länge / length	mm	225
Anschlussgewinde / air nipple	Zoll	1/4"
Schlauchanschluss / air hose	mm	9-13
Luftverbrauch / air consumption	l/min	180
Drehzahl/min / free speed	Rpm	1400
Arbeitsdruck / air pressure	bar	6,2
Geräuschpegel / sound level	dBA	76



**Optimal auch in Verwendung mit MÜLLER extra kurzen Linksbohrern Nr. 562 400**  
Ideal in use with MUELLER extra short left drill bits No. 562 400

## 1/2" XS SCHLAGSCHRAUBER, EXTRA KURZ 1/2" XS IMPACT WRENCH, ULTRA SHORT



**3-stufiger Leistungsregler**  
 3-step power-control

**Sehr niedrige Bauhöhe**  
 Very low construction-height

109 mm

**Ideal für sehr schwer erreichbare Arbeitspositionen**  
 Made for hard to reach areas



**Sehr starke Leistung: max. 677Nm**  
 High Power: max. 677Nm

**Stufenloser Abzug**  
 Variable speed trigger

**Einhand-Umschalter**  
 One hand switch

**WE SET THE STANDARD FOR TORQUE!**

**Extra kurz, Extra stark!**  
**Ultra short, Extra strong!**

<b>MÜLLER-WERKZEUG</b> Technische Daten / technical information		<b>1/4" MÜLLER 112</b>	
		rechts	links
<b>Max. Lösemoment / breakaway torque</b>	Nm	615	677
<b>Luftverbrauch / air consumption</b>	l/min	134	134
<b>Drehzahl / free speed</b>	rpm	9.000 / 6.3 bar 10.500 / 8.0 bar	
<b>Antrieb / drive</b>	inch	1/2"	
<b>Gewicht / weight</b>	Kg	1.3	
<b>Länge / length</b>	mm	108	
<b>Max. Arbeitsdruck / air pressure</b>	bar	6.35	
<b>Geräuschpegel / sound level</b>	dBA	95	
<b>Anschlussgewinde / air nipple</b>	inch	1/4"	
<b>Schlauch / air hose</b>	mm	10	
<b>Vibration / vibration level</b>	m/s	9.60	

**DER MAßSTAB FÜR KRAFT!**



**Nr. 810 700**  
**XS-Stubby Impact Satz extra kurz,**  
**Antrieb 1/2" 10-24mm auf Leiste**  
 XS-Stubby Impact socket kit 10-24mm on rail



**Ultimative Power! Sehr starker Schlagschrauber mit neuartigem Design.** Ergonomisch perfekt angepasster Griff. Einhand-Umschalter kann auf Links- und Rechtshänder umgestellt werden. Geschwindigkeit + Rechts- und Links-Umstellung kann mit einer Hand bedient werden.

**Nr. EQ-294 112 1/2" XS Schlagschrauber, extra kurz**  
 Code: OE148000148



**Very strong Impact Wrench with new design.** Ergonomic handle. Variable speed trigger. One hand switch. 3-speed control. Forward & reverse control can be switched to left or right handed. Aluminium / magnesium housing. Extremely powerful.

**1/2" XS Impact Wrench, Ultra Short**

Druckluft-Werkzeuge Power Tools  
 1  
 Fahrwerk Suspension  
 2  
 Bremse & Rad Brake & Wheel  
 3  
 Motor Engine-Tools  
 4  
 Zerspanung Cutting Tools  
 5  
 Karosserie/Verschleiß AutoBody/Consumables  
 6  
 Universal-Werkzeuge Universal Tools  
 7  
 Transporter & LKW Heavy Duty & Trucks  
 8  
 Equipment  
 9  
 Inhaltsverzeichnis Table of Contents

## 1/2" MÜLLER SCHLAGSCHRAUBER, 80 NM/8BAR 1/2" MUELLER IMPACT GUN, 80 NM/8BAR

WE SET THE STANDARD  
FOR **TORQUE!**



**Schlagschrauber speziell für den Reifenwechsel.**  
Volle Leistung von 1600Nm zum Lösen. Reduzierte Leistung im Rechtslauf mit maximalen Anzugsmoment ca. 80Nm bei 8,0bar. Mit diesem Müller Schlagschrauber können die Radschrauben nach Werksvorschrift vormontiert, und mit dem Drehmoment-schlüssel nachgezogen werden.

**Nr. EQ-294 114/80er 1/2" Müller Schlag-schrauber, 80Nm/8bar**  
Code: OE228000228



**Impact gun specially engineered for the wheel change.**  
Full power of 1600Nm in reverse. Reduced power for torque on with a max of roughly 80Nm at 8,0bar. This Mueller impact gun ensures a wheel bolt pre-mounting and a final fixing with the torque wrench as requested from car manufacturer.

**Nr. EQ-294 114/80er 1/2" Mueller impact gun, 80Nm/8bar**  
Code: OE228000228

**Losbrechmoment 1600Nm**  
Breakaway torque 1600Nm

**Mit Begrenzung im Rechtslauf**  
Torque on restricted

**DER MAßSTAB FÜR  
KRAFT!**

## SCHUTZHÜLLEN FÜR MÜLLER-SCHLAGSCHRAUBER PROTECTIVE COVERS FOR MUELLER IMPACT WRENCHES



Hochbelastbar, abriebfest, schützen das Gerät zuverlässig.

Nr. 294 114/SH Schutzhülle für MÜLLER 114 1/2"  
Code: OE180000018

Nr. 294 115/SH Schutzhülle für MÜLLER 115 1/2" Mini + 3/8"  
Code: OE180000018

Nr. 294 117/SH Schutzhülle für MÜLLER 117 3/4"  
Code: OE280000028



Heavy-duty, abrasion resistant, reliably protects the tool.

Protective cover for MUELLER 114 1/2"

Protective cover for MUELLER 115 1/2" Mini + 3/8"

Protective cover for MUELLER 117 3/4"



**MÜLLER-SCHLAGSCHRAUBER**  
IMPACT WRENCH



**3-stufiger Leistungsregler**  
3-step power-control

**Aluminium/Magnesium Schlagwerk-Gehäuse**  
housing

**Doppelhammer-Schlagwerk**  
Twin-Hammer

**ergonomischer Griff**  
ergonomic handle

**stufenloser Abzug**  
variable speed trigger

**echte Einhand-Bedienung**  
one handed operation

**DER MAßSTAB FÜR KRAFT!**

MÜLLER-WERKZEUG Technische Daten / technical information	1/4" MÜLLER 113		1/2" MÜLLER 114		1/2" MINI MÜLLER 115		3/8" MÜLLER 116		
	rechts	links	rechts	links	rechts	links	rechts	links	
Max. Lösemoment / breakaway torque	Nm	90	90	1084	1600	500	680	500	680
Luftverbrauch / air consumption	l/min	105	105	135	135	105	105	105	105
Drehzahl / free speed	rpm	10.000	10.000	8.100	7.800	10.200	11.500	10.200	11.500
Antrieb / drive	inch	1/4"		1/2"		1/2"		3/8"	
Gewicht / weight	Kg	0.90		1.80		1.08		1.08	
Länge / length	mm	118		174		146		146	
Max. Arbeitsdruck / air pressure	bar	6,2		6,2		6,2		6,2	
Geräuschpegel / sound level	dBA	98.2		94.2		93.5		93.5	
Anschlussgewinde / air nipple	inch	1/4"		1/4"		1/4"		1/4"	
Schlauch / air hose	mm	9-13		9-13		9-13		9-13	
Vibration / vibration level	m/s	2.96		2.96		7.50		4.80	

**MÜLLER 114**

**WE SET THE STANDARD FOR TORQUE!**



**Ultimative Power! Sehr starker Schlagschrauber mit neuartigem Design.** Ergonomisch perfekt angepasster Griff. Einhand-Umschalter kann auf Links- und Rechtshänder umgestellt werden. Geschwindigkeit + Rechts- und Links-Umstellung kann mit einer Hand bedient werden.



**Very strong Impact Wrench with new design.** Ergonomic handle. Variable speed trigger. One hand switch. 3-speed control. Forward & reverse control can be switched to left or right handed. Aluminium/ magnesium housing. High powerful twin-hammer.

**Ausführungen / models:**

1/4"



1/2"



1/2" MINI + 3/8"



**Nr. 294 114 1/2" Schlagschrauber, max. 1600 Nm**

Code: OE22800228

**Nr. 294 115 1/2" MINI-Schlagschrauber, max. 680 Nm**

Code: OE218000218

Nr. 294 113 1/4" Schlagschrauber, max. 90 Nm

Code: OE158000158

Nr. 294 116 3/8" MINI-Schlagschrauber, max. 680 Nm

Code: OE248000248

**1/2" Impact Wrench, max. 1600Nm**

**1/2" MINI-Impact Wrench, max. 680Nm**

1/4" Impact Wrench, max. 90Nm

3/8" MINI-Impact Wrench, max. 680Nm

Druckluft-Werkzeuge Power Tools  
1  
Fahrwerk Suspension  
2  
Brems- & Rad Brake & Wheel  
3  
Motor Engine-Tools  
4  
Zerspanung Cutting Tools  
5  
Karosserie/Verschleiß AutoBody/Consumables  
6  
Universal-Werkzeuge Universal Tools  
7  
Transporter & LKW Heavy Duty & Trucks  
8  
Equipment  
9  
Inhaltsverzeichnis Table of Contents

# MÜLLER SCHLAGSCHRAUBER IN SIGNALFARBE MUELLER IMPACT GUN

# SIGNAL



**Signalfarbe zur besseren Unterscheidung: "Wem gehört welches Werkzeug?"**

**Ultimative Power! Sehr starker Schlagschrauber mit neuartigem Design.** Ergonomisch perfekt angepasster Griff. Einhand-Umschalter kann auf Links- und Rechtshänder umgestellt werden. Geschwindigkeit + Rechts- und Links-Umstellung kann mit einer Hand bedient werden.



**Very strong Impact Wrench with new design.** Ergonomic handle. Variable speed trigger. One hand switch. 3-speed control. Forward & reverse control can be switched to left or right handed. Aluminium / magnesium housing. High powerful twin-hammer.

**Doppelhammer-Schlagwerk**  
Twin-Hammer



**MÜLLER 114**

**stufenloser Abzug**  
variable speed trigger

**echte Einhand-Bedienung**  
one handed operation

**DER MAßSTAB FÜR KRAFT!**

**Aluminium/Magnesium Schlagwerk-Gehäuse**  
housing



**ergonomischer Griff**  
ergonomic handle



**3-stufiger Leistungsregler**  
3-step power-control

**WE SET THE STANDARD FOR TORQUE!**

MÜLLER-WERKZEUG		1/2" MÜLLER 114	
Technische Daten / technical information		rechts	links
Max. Lösemoment / breakaway torque	Nm	1084	1600
Luftverbrauch / air consumption	l/min	135	135
Drehzahl / free speed	rpm	8.100	7.800
Antrieb / drive	inch	1/2"	
Gewicht / weight	Kg	1.80	
Länge / length	mm	174	
Max. Arbeitsdruck / air pressure	bar	6,2	
Geräuschpegel / sound level	dBA	94,2	
Anschlussgewinde / air nipple	inch	1/4"	
Schlauch / air hose	mm	9-13	
Vibration / vibration level	m/s	2.96	

**Nr. 294 114/Signal** 1/2" Schlagschrauber neon-grün, max. 1600 Nm  
Code: OE228000228

**Nr. 294 114/orange** 1/2" Schlagschrauber orange, max. 1600 Nm  
Code: OE228000228

1/2" Impact Wrench neon-green, max. 1600Nm

1/2" Impact Wrench orange, max. 1600Nm

Druckluft-Werkzeuge  
Power Tools  
1  
Fahrwerk  
Suspension  
2  
Bremsen & Rad  
Brake & Wheel  
3  
Motor  
Engine-Tools  
4  
Zerspanung  
Cutting Tools  
5  
Karosserie/Verschleiß  
AutoBody/Consumables  
6  
Universal-Werkzeuge  
Universal Tools  
7  
Transporter & LKW  
Heavy Duty & Trucks  
8  
Equipment  
9  
Inhaltsverzeichnis  
Table of Contents



3-step power control

**3-stufiger Leistungsregler**  
3-step power-control

**Aluminium/Magnesium Schlagwerk-Gehäuse**  
housing

**Doppelhammer-Schlagwerk**  
Twin-Hammer

**stufenloser Abzug**  
variable speed trigger

**echte Einhand-Bedienung**  
one handed operation

**ergonomischer Griff**  
ergonomic handle

**3/4" MÜLLER-SCHLAGSCHRAUBER**  
**3/4" IMPACT WRENCH**

WE SET THE STANDARD  
FOR **TORQUE!**

**MÜLLER**  
**117**



<b>MÜLLER-WERKZEUG</b>		<b>3/4" MÜLLER 117</b>	
<b>Technische Daten / technical information</b>			
		rechts	links
<b>Max. Lösemoment / breakaway torque</b>	Nm	2000	2600
<b>Luftverbrauch / air consumption</b>	l/min	200	210
<b>Drehzahl / free speed</b>	rpm	5.300	6.400
<b>Antrieb / drive</b>	inch	3/4"	
<b>Gewicht / weight</b>	Kg	3.20	
<b>Länge / length</b>	mm	215	
<b>Max. Arbeitsdruck / air pressure</b>	bar	6,2	
<b>Geräuschpegel / sound level</b>	dBA	105.1	
<b>Anschlussgewinde / air nipple</b>	inch	3/8"	
<b>Schlauch / air hose</b>	mm	9-13	
<b>Vibration / vibration level</b>	m/s	6.50	



**Nr. 801 800**

**3/4" Impact Stecknuss Satz**  
3/4" Impact Socket Kit

DER MAßSTAB FÜR  
**KRAFT!**



**Ultimative Power! Sehr starker Schlagschrauber mit neuartigem Design.** Ergonomisch perfekt angepasster Griff. Einhand-Umschalter kann auf Links- und Rechtshänder umgestellt werden. Geschwindigkeit + Rechts- und Links-Umstellung kann mit einer Hand bedient werden.

**Nr. 294 117 3/4" Schlagschrauber, max. 2600 Nm**  
Code: OE66800668



**Very strong Impact Wrench with new design.** Ergonomic handle. Variable speed trigger. One hand switch. 3-speed control. Forward & reverse control can be switched to left or right handed. Aluminium/ magnesium housing. High powerful twin-hammer.

**3/4" Impact Wrench, max. 2600Nm**

# INDUSTRIE-DRUCKLUFTKNARRE AIR RATCHET

DER MAßSTAB FÜR  
**KRAFT!**

WE SET THE STANDARD  
FOR **TORQUE!**

ULTIMATIVE POWER  
1/2" 170Nm

<b>MÜLLER-WERKZEUG</b>		<b>MÜLLER 214</b>	<b>MÜLLER 215</b>	<b>MÜLLER 216</b>	<b>MÜLLER 217</b>
Technische Daten / technical information					
Antrieb / square drive	inch	1/2"	3/8"	1/4"	3/8"
Max. Drehmoment / max. torque	Nm	170	170	60	60
Drehzahl / free speed	Rpm	180	180	270	270
Luftverbrauch / air consumption	l/min	113	113	100	100
Gewicht / weight	Kg	1.55	1.55	0.70	0.70
Länge / length	mm	320	320	225	225
Max. Arbeitsdruck / air pressure	bar	6,2	6,2	6,2	6,2
Geräuschpegel / sound level	dBA	84,2	84,2	92,1	92,1
Anschlussgewinde / air inlet	inch	1/4"	1/4"	1/4"	1/4"
Schlauch / air hose	mm	9-13	9-13	9-13	9-13
Vibration / vibration level	m/s	10,2	10,2	14,1	14,1



**Hochleistungs-Druckluftknarre mit neuartigem Design.** Ergonomisch perfekt angepasster Griff. Ultimative Leistung! Stufenloser Abzug. 360° drehbarer Abluftring.

**Nr. EQ-294 214 MÜLLER 214 1/2" Druckluftknarre**  
Code: OE218000218

**Nr. EQ-294 215 MÜLLER 215 3/8" Druckluftknarre**  
Code: OE218000218

**Nr. EQ-294 216 MÜLLER 216 1/4" Druckluftknarre**  
Code: OE168000168

**Nr. EQ-294 217 MÜLLER 217 3/8" Druckluftknarre**  
Code: OE168000168



**Air ratchet with perfect handling.** Ergonomichandle. 360° turnable exhaust. Ultimate torque!

**MUELLER 214 1/2" Air Ratchet**

**MUELLER 215 3/8" Air Ratchet**

**MUELLER 216 1/4" Air Ratchet**

**MUELLER 217 3/8" Air Ratchet**

**DER MAßSTAB FÜR  
KRAFT!**

**1" MÜLLER-SCHLAGSCHRAUBER  
1" MUELLER IMPACT GUN**



**Lange Spindel: 190mm**  
Long anvil: 190mm

Nr. 294 119/V2

**WE SET THE STANDARD  
FOR TORQUE!**



Nr. 294 118/V2

<b>MÜLLER-WERKZEUG</b> Technische Daten / technical information		
Antrieb / square drive	Zoll	1"
Max. Drehmoment / max. torque	Nm	3100
Anschlussgewinde / Air inlet	Zoll	1/2"
Gewicht / weight	Kg	6,8
Schlauchanschluss / air hose	mm	9-13
Luftverbrauch / air consumption	l/min	305
Drehzahl/min / free speed	Rpm	48
Arbeitsdruck / air pressure	bar	6,3
Geräuschpegel / sound level	dBA	110



**1" Schlagschrauber mit neuartigem Design.** Doppelschlagwerk. Magnesium Schlagwerk-Gehäuse. Extrem schneller Drehmomentaufbau. 4-stufige Einstellmöglichkeit der Schlagleistung. Sehr leichte Bauweise. Gesamtgewicht 6.8Kg. Kurze Antriebsspindel: 38mm oder lange Antriebsspindel: 190mm.

Max. Losbrechmoment: 3100Nm.  
Das Gerät kann von Rechts- und Linkshändern bedient werden.

**Nr. 294 118/V2 1" Druckluft-Schlagschrauber, kurze Spindel**  
Code: OE998000998

**Nr. 294 119/V2 1" Druckluft-Schlagschrauber, lange Spindel**  
Code: OE998000998



**1" Impact wrench with perfect handling.** Powerful twin-hammer mechanism. Magnesium housing. Lightest 1" impact-gun. Only 6.8Kg weight. Short anvil: 38mm. Long anvil: 190mm.  
Max. torque: 3100Nm

**1" MUELLER Impact Gun, short anvil**

**1" MUELLER Impact Gun, long anvil**

Druckluft-Werkzeuge  
Power Tools  
1  
Fahrwerk  
Suspension  
2  
Brems- & Rad  
Brake & Wheel  
3  
Motor  
Engine-Tools  
4  
Zerspanung  
Cutting Tools  
5  
Karosserie/Verschleiß  
AutoBody/Consumables  
6  
Universal-Werkzeuge  
Universal Tools  
7  
Transporter & LKW  
Heavy Duty & Trucks  
8  
Equipment  
9  
Inhaltsverzeichnis  
Table of Contents



# MIKRO-STABSCHLEIFER MICRO DIE GRINDER

**Stufenlose Drehzahlregelung**  
Variable speed



<b>MÜLLER-WERKZEUG</b> Technische Daten / technical information		
Drehzahl / free speed	RPM	70.000
Spannzange / collet	mm	3.0
Luftanschluss / air Inlet	NPT	1/4
Mindest-Schlauchdurchmesser / hose (I.D.)	mm	5
Luftdruck / air pressure	bar	6.2
Luftverbrauch / air consumption	l/min	28.3
Länge / length	mm	137
Gewicht / shipping wt.	Kgs	0.25
Vibration / vibration	m/s <sup>2</sup>	2,1
Geräuschpegel / sound power level	dBA	84
Geräuschpegel Leerlauf / sound Pressure Level	dBA	74



**Mini Composit Gerät** der neuesten Generation für kleine und feine Schleif- und Fräsarbeiten. Maximale Rundlaufgenauigkeit durch Präzisions-Spannzange, minimale Vibration, Fräser "schlägt" weniger zurück, geringer Geräuschpegel, perfektes Handling durch neuartige **BIONIGRIP Oberfläche**. Abluft durch Schlauch nach hinten.

**Nr. 297 001 Mikro-Stabschleifer "BIONIGRIP"**  
Code: OE138000138



**The latest generation mini composite tool** for small and precise grinding and milling. Provides maximum concentricity through its precision collet, minimal vibration, less "kick back", low noise level and perfect handling due to the new **BIONIGRIP surface**. Air exhaust through hose to the rear.

**Micro Die Grinder "BIONIGRIP"**



Nr. 297 001/ZYB3



Nr. 297 001/KUD3



Nr. 297 001/WRC3



Nr. 297 001/RBF3



Nr. 297 001/SPG3



**Nr. 297 001/Kit5 Vollhartmetall-Frässtift-Satz, 5tlg.**  
Code: OE890000089

Nr. 297 001/ZYB3 Code: OE680000068	Zylinder stirnverzahnt 3,0mm	Pack 3 Stk.
Nr. 297 001/KUD3 Code: OE780000078	Kugelform 4,0mm, Schaft 3,0mm	Pack 3 Stk.
Nr. 297 001/WRC3 Code: OE680000068	Walzenrundform 3,0mm	Pack 3 Stk.
Nr. 297 001/RBF3 Code: OE680000068	Rundbogen 3,0mm	Pack 3 Stk.
Nr. 297 001/SPG3 Code: OE680000068	Spitzbogenform 3,0mm	Pack 3 Stk.



**Carbide Milling and Grinding Burrs Set, 5 pcs.**

Cylindrical with end cut burrs 3.0mm	Pack 3 pcs.
Ball Head burrs 4.0 mm Shank 3.0mm	Pack 3pcs.
Rounded tip (Bull Nosed) burrs 3.0mm	Pack 3pcs.
Small rounded (Round tree) tip burrs 3.0mm	Pack 3pcs.
Pointed tip (Pointed tree) burrs 3.0mm	Pack 3pcs.

**MINI WINKEL-TRENNSCHEIFER**  
**MINI ANGLE DISC CUTTER**



**Mini Winkel-Trennschleifer zur Anwendung in schwer zugänglichen Bereichen.** Für Trenn- und Schruppscheiben mit Durchmesser 50mm.  
 Aufnahmebohrung 10mm. Funkenschutz drehbar.

**Nr. 297 003 Mini Winkel-Trennschleifer**  
 Code: OE128000128



**Mini angle disc cutter for use in hard to reach areas.** For cutting and grinding wheels diameter 50mm: Center bore 10mm. Spark protector is adjustable.

**Mini angle disc cutter**

**optional**



**Mini Lamellenscheiben  
 Ø 50mm, 10er Pack**  
 Mini flap disc Ø 50mm, 10pack

**Nr. 111 550/K40 Körnung K40**  
 Code: OE290000029 grid K40

**Nr. 111 550/K60 Körnung K60**  
 Code: OE290000029 grid K60

**Nr. 111 550/K80 Körnung K80**  
 Code: OE290000029 grid K80

**optional**



**1x Aufnahmeschaft  
 für Roloc Ø 50mm**  
 1x Adapter for Roloc Ø 50mm

**Nr. 111 052**

**optional**



**Ersatz-Trennscheiben  
 Ø 50mm x 0,8, 10 Stk.**  
 Replacement Cutting discs  
 Ø 50mm x 0.8, 10 pcs.

**Nr. 110 458**  
 Code: OE220000022

Druckluft-Werkzeuge  
 Power Tools  
 1  
 Fahrwerk  
 Suspension  
 2  
 Bremse & Rad  
 Brake & Wheel  
 3  
 Motor  
 Engine-Tools  
 4  
 Zerspanung  
 Cutting Tools  
 5  
 Karosserie/Verschleiß  
 AutoBody/Consumables  
 6  
 Universal-Werkzeuge  
 Universal Tools  
 7  
 Transporter & LKW  
 Heavy Duty & Trucks  
 8  
 Equipment  
 9  
 Inhaltsverzeichnis  
 Table of Contents

# DL-STABSCHLEIFER AIR DIE GRINDER

## BIONIGRIP



**Präzisions-Spannzange 6,0 mm**  
precision collet 6.0 mm

**spannt auch Vollhartmetall**  
can be used also for carbide

**stufenlose Drehzahleinstellung**  
stepless trigger



MULLER-WERKZEUG Technische Daten / technical information		
Gewicht / weight	Kg	0,5
Länge / length	mm	175
Präzisions-Spannzange / precision collet	mm	6
Drehzahl / free speed	RPM	24.000
Gewinde / air Inlet	NPT	1/4"
Schlauch / hose	mm	min. 10
Luftverbrauch / air consumption	l/min	116



Verschiedene Hochleistungs-Mini-Trennscheiben, Bohrung 10mm

Various high performance Mini cut off discs, 10mm bore

**Nr. 110 400 Trennscheibensortiment, 9tlg.**  
Code: OE380000038 **Cut off disc kit, 9pcs.**

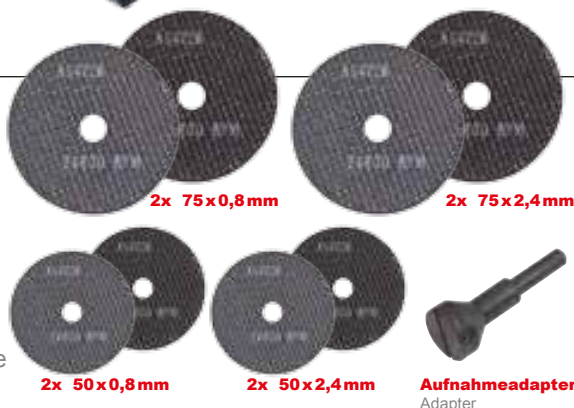

**Sehr starkes 0,75 PS Composit-Gerät der neuesten Generation.** Maximale Rundlaufgenauigkeit durch Präzisions-Spannzange, minimale Vibration, Fräser „schlägt“ weniger zurück, geringer Geräuschpegel, maximale Leistung, perfektes Handling durch neuartige Bionigrip Oberfläche. Abluft nach hinten.

Präzisions-Industriespannzange 6,0mm anstatt wie üblich 1/4". Somit spannen z. B. Hartmetallfräser auf die gesamte Länge. Besserer Rundlauf. Läuft ruhiger.

**Nr. 297 004 DL-Stabschleifer "BIONIGRIP"**  
Code: OE108000108

**Very strong 0.75 HP - Latest generation of composite tools.** Maximum concentricity via its precision collet, minimal vibration, less "kick back" from cutters, low noise level, maximum power, perfect handling due to its new Bionigrip handle surface. Air exhaust to the rear.

Precision Industry Collet 6.0 mm instead of the usual 1/4". Therefore clamp carbide cutters over the entire length. Improved concentricity. Runs quieter.

**Air Die Grinder "BIONIGRIP"**

**DL-STABSCHLEIFER 90°**  
**AIR DIE GRINDER 90°**

**BIONIGRIP**



**Präzisions-Spannzange 6,0 mm**  
precision collet 6.0 mm

**spannt auch Vollhartmetall**  
can be used also for carbide

**stufenlose Drehzahleinstellung**  
stepless trigger

<b>MÜLLER-WERKZEUG</b> Technische Daten / technical information		
<b>Gewicht / weight</b>	Kg	0,82
<b>Länge / length</b>	mm	177
<b>Präzisions-Spannzange / precision collet</b>	mm	6
<b>Drehzahl / free speed</b>	RPM	24.000
<b>Gewinde / air Inlet</b>	NPT	1/4"
<b>Schlauch / hose</b>	mm	min. 10
<b>Luftverbrauch / air consumption</b>	l/min	116



**Nr. 106 500**  
Code: OE198000198

**Hartmetallfräser-Satz**  
Carbide Cutter Kit

**Für Druckluftschleifer**  
**ab 20.000 U/min.**  
For use of air grinder  
from 20.000 rpm



**Sehr starkes 0,75 PS Composit-Gerät der neuesten Generation.** Maximale Rundlaufgenauigkeit durch Präzisions-Spannzange, minimale Vibration, Fräser „schlägt“ weniger zurück, geringer Geräuschpegel, maximale Leistung, perfektes Handling durch neuartige Bionigrip Oberfläche. Abluft nach hinten.

Präzisions-Industriespannzange 6,0mm anstatt wie üblich 1/4". Somit spannen z. B. Hartmetallfräser auf die gesamte Länge. Besserer Rundlauf. Läuft ruhiger.

**Nr. 297 005 DL-Stabschleifer "BIONIGRIP"**  
Code: OE118000118 **90°**



**Very strong 0.75 HP - Latest generation of composite tools.** Maximum concentricity via its precision collet, minimal vibration, less "kick back" from cutters, low noise level, maximum power, perfect handling due to its new Bionigrip handle surface. Air exhaust to the rear.

Precision Industry Collet 6.0 mm instead of the usual 1/4". Therefore clamp carbide cutters over the entire length. Improved concentricity. Runs quieter.

**Air Die Grinder "BIONIGRIP" 90°**

Druckluft-Werkzeuge  
Power Tools  
1  
Fahrwerk  
Suspension  
2  
Brems- & Rad  
Brake & Wheel  
3  
Motor  
Engine-Tools  
4  
Zerspanung  
Cutting Tools  
5  
Karosserie/Verschleiß  
AutoBody/Consumables  
6  
Universal-Werkzeuge  
Universal Tools  
7  
Transporter & LKW  
Heavy Duty & Trucks  
8  
Equipment  
9  
Inhaltsverzeichnis  
Table of Contents

# 1PS DRUCKLUFT-TIEFENSCHNEIDER 1HP EXTENDED AIR CUTTER

**Kälteisolierter Handgriff**  
cold insulated handle

**Vibrationsarm**  
vibration reduced

**Spindelblockierung durch Druckknopf**  
Integrated locking button for disc change

**Für Trennscheiben bis 100 x 1,0 x 10 mm**  
Disc sizes 100 x 1.0 x 10 mm

39mm

**Geringe Bauhöhe, geeignet für beengten Einsatz**  
extra slim construction for limited access areas

**Nr. 101 100**  
Code: OE38000038

**Ersatz-Trennscheiben Ø 100mm, 10 Stk.**  
Replacement Cutting discs Ø 100mm, 10 pcs.

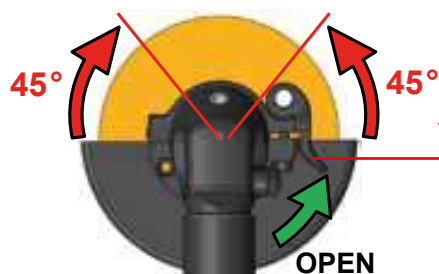

**Werkzeuglose Schnellverstellung der Schutzhaube durch Druckknopf**  
Disc protection can be locked without tools as well

MÜLLER-WERKZEUG Technische Daten / technical information		
Schneidrad / cutting wheel	mm	100
Länge / length	mm	345
Drehzahl / free speed	RPM	14.000
Anschlussgewinde / connecting thread	Zoll	1/4"
Schlauch / air hose	mm	10
Luftverbrauch / avg air cons	CFM	4.1



Für schwer zugängliche, tiefliegende Stellen wie z. B. am Auspuff, Verschraubungen, Gummilager, Krümmer etc.

**Nr. 297 008 1PS Druckluft-Tiefenschneider**  
Code: OE238000238



For restricted access as exhaust system, manifold, bushing bolts etc.

**1HP Extended Air Cutter**

**STABRADIERER**  
**AIR ERASER**

**BIONIGRIP**



Speziell zur Verwendung mit diesen Scheiben abgestimmter Getriebe-Druckluftschleifer mit 1 PS Leistung. Hervorragend zur **Entfernung von Aufklebern, Zierstreifen, TÜV-Plaketten, Farbspritzern** auf Lacken. Verwendung von Schabern oder Heißluftföhn entfällt. Scheibe Ø 100 x 15 mm.

**Nr. 297 010 Stabradierer** komplett mit 1 Raderscheibe Ø 100mm  
Code: OE128000128

Nr. 297 011 Raderscheibe Ø 100mm einzeln  
Code: OE140000014

Nr. 297 111 Raderscheiben Ø 100mm 10 Stk.  
Code: OE133000133 + 1 Adapter für Bohrmaschine



Especially for use with discs designed for air grinders with 1 HP power. Also excellent for **removing stickers, decorative strips**, splashes of color on paint. No longer necessary to use scrapers or heat gun. Disc diameter 100 x 15 mm.

**Air Eraser** complete with 1 erasing disc Ø 100mm

Erasing disc Ø 100mm separate

Erasing discs Ø 100mm 10 pcs.  
+ 1 adaptor for drills

**FELGEN-RADIERSCHEIBE**  
**CONICAL ERASER FOR RIMS**

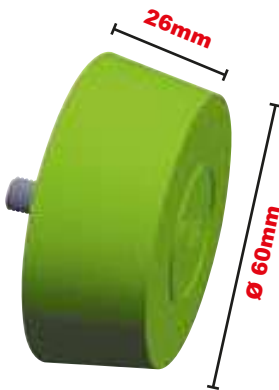

Konische Raderscheibe zum Entfernen der Kleberückstände von Auswuchtgewichten. Zur Verwendung mit Stabradierer Nr. 297 010 etc..

**Nr. 282 260 Felgen-Raderscheibe**  
Code: OE980000980



Conical eraser disc to remove the adhesives of wheel weights. For use with air eraser no. 297 010.

**Conical eraser for rims**

**ADAPTER**



**Nr. 297 013**  
Code: OE780000780

**Adapter für Bohrfutter**  
passend für  
Nr. 297 011 + Nr. 282 260



**Nr. 297 013**  
Code: OE780000780

**Adapter for Drill-Chuck**  
fits for no. 297 011 + no. 282 260

Druckluft-Werkzeuge Power Tools  
1  
Fahrwerk Suspension  
2  
Brems- & Rad Brake & Wheel  
3  
Motor Engine-Tools  
4  
Zerspanung Cutting Tools  
5  
Karosserie/Verschleiß AutoBody/Consumables  
6  
Universal-Werkzeuge Universal Tools  
7  
Transporter & LKW Heavy Duty & Trucks  
8  
Equipment  
9  
Inhaltsverzeichnis Table of Contents

## GLÜHKERZEN VIBRO AUSDREHER GLOW PLUG VIBRO EXTRACTOR



### VIBRO-IMPACT®

**VIBRO-IMPACT® erzeugt kontrollierten Vibrationsimpuls**

VIBRO-IMPACT® generates a controlled turn impact impulse



**Antrieb: 1/4"**  
Drive: 1/4"

**Einhand-Umschalter**  
One hand switch

**Stufenloser Abzug**  
Variable speed

**4-Stufen einstellbares Linksdrehmoment, 10/20/30/40Nm**  
Adjustable 4-stepped left hand torque, 10/20/30/40Nm

MÜLLER-WERKZEUG Technische Daten / technical information			
Antrieb / drive	Zoll	1/4"	
		Rechts / right	Links / left
Max. Drehmoment / max. torque	Nm	40	10 / 20 / 30 / 40
Gewicht / weight	Kg	0,9	
Anschlussgewinde / air nipple	Zoll	1/4"	
Schlauch / hose	mm	9-13	
Luftverbrauch / air consumption	l/min	250	
Drehzahl (leer) / speed (empty)	Rpm	12.000	
Arbeitsdruck / air pressure	bar	6,3 (90psi)	
Geräuschpegel / sound level	dBA	60	
Vibration / vibration	m/s <sup>2</sup>	2,1	

**Für alle Glühstifte mit SW8, 9, 10, 11 + 12**  
For all glow plugs 8, 9, 10, 11 + 12 mm



 **Das Gerät erzeugt einen kontrollierten Dreh-Schlagimpuls.** Original VIBRO-IMPACT®. Durch ein in 4 Stufen einstellbares Linksdrehmoment kann ein Abreißen weitgehend verhindert werden. Satz bestehend aus Druckluftgerät 1/4", Stecknüsse SW 8, 9, 10, 11, 12 x 1/4", 2 Verlängerungen und 1/4" Kugelgelenk.

**Nr. 600 289** **Glühkerzen Vibro-Ausdreher**  
Code: OE238000238

 **The special air tool generates a controlled turn-impact impulse.** Based on the adjustable 4-stepped left hand torque, a break of the glow plug will be avoided in the most cases. Kit includes special air tool 1/4", glow plug impact sockets 8, 9, 10, 11, 12mm x 1/4", 2 suspensions and 1/4" ball joint.

**Glow plug vibro extractor**

**DL-DOPPELGELENK**  
**1/4" 2x 360°**  
**AIR SWIVEL 2x 360°**



**Universell verwendbares Gelenk** zur besseren und komfortableren Anwendung von Druckluftwerkzeugen. Sehr leichtgängig. Verstärkte Ausführung. Gute Zugfestigkeit. Gehärtete Stahl-Gewindenippel.

**Nr. 400 035 DL-Doppelgelenk**  
Code: OE220000022  
**1/4" 2x 360°**



**Universal swivel joint inlet** for better maneuverability. Heat treated connecting screw. 2x 360° rotation. Industrial quality.

**Nr. 400 035 Air Swivel 2x 360°**  
Code: OE220000022

**DOPPELGELENK MIT LEISTUNGSREGLER**  
**SWIVEL JOINT WITH REGULATOR**

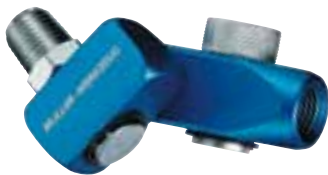

2x 360° Drehung für einfaches Handling von Druckluftgeräten mit stufenlosem Leistungsregler. Gewinde: 1/4" NPT, Max: 10 bar

**Nr. 400 036 Doppelgelenk mit Leistungsregler**  
Code: OE270000027



2x 360° rotation for easy handling of air tools with integrated regulator. Heat treated connecting screw. 1/4" NPT, Max. 150 psi

**Nr. 400 036 Swivel Joint with Regulator**  
Code: OE270000027

**SIGNAL-GELENKSCHLAUCH**  
**SIGNAL JOINT HOSE**



**Flexibler SIGNAL-Schlauch mit Kugelgelenk.** 1/4" Anschlussstück. Innen-Ø: 10mm.

**Nr. 290 434 SIGNAL-Gelenkschlauch**  
Code: OE160000016



**Flexible SIGNAL hose with ball joint.** 1/4" connector. Inner-Ø: 10mm.

**Nr. 290 434 SIGNAL Joint Hose**  
Code: OE160000016

**SIGNAL**



**Länge: 390mm**  
Length: 390mm

**HARTMETALLFRÄSER-SATZ**  
**CARBIDE CUTTER KIT**

**Für Druckluftscheifer ab 20.000 U/min.**

For use of air grinder from 20.000 rpm

**TIN-beschichtet**  
TIN-coated



**Hochleistungsfräser** zur Bearbeitung von gehärtetem Stahl, Schweißnähten, Gusswerkstoffen usw. Aus Vollmaterial geschliffen. TIN-beschichtet. Zur Verwendung in Druckluftscheifern ab 20.000 U/min. Lieferung komplett im Holzkasten. Schaft ø 6,0 mm.

**Nr. 106 500 Hartmetallfräser Satz 5-tlg.**  
Code: OE198000198



**Top quality cutters** for working on hardened steels, welding joints, cast steel. One piece grinded. TIN coated. For the use of air grinders from 20.000 rpm and more. Shipment in massive wood box. Shaft ø 6,0 mm.

**Nr. 106 500 Carbide cutter kit 5pcs.**  
Code: OE198000198



**Fräser einzeln erhältlich**  
Carbide cutter separately available:

**Ø 8mm**

Nr. 106 008  
Code: OE380000038

**Ø 10mm**

Nr. 106 010  
Code: OE380000038

**Ø 10mm**

Nr. 107 010  
Code: OE440000044

**Ø 10mm**

Nr. 108 010  
Code: OE440000044

**Ø 10mm**

Nr. 109 010  
Code: OE440000044



**Ø 6mm Schaft / Shaft**

Druckluft-Werkzeuge Power Tools  
1  
Fahrwerk Suspension  
2  
Bremsen & Räder Brake & Wheel  
3  
Motor Engine-Tools  
4  
Zerspanung Cutting Tools  
5  
Karosserie/Verschleiß AutoBody/Consumables  
6  
Universal-Werkzeuge Universal Tools  
7  
Transporter & LKW Heavy Duty & Trucks  
8  
Equipment  
9  
Inhaltsverzeichnis Table of Contents



## SIGNAL-DRUCKLUFTSCHLAUCH SIGNAL AIR HOSE

3/8" - 10mm — **SIGNAL** — **MÜLLER-WERKZEUG** — **SIGNAL** — **MÜLLER-WERKZEUG**

# SIGNAL

- Gut sichtbare **SIGNAL** Farbe
- Temperaturbeständig von **-40°C bis +65°C**
- **Abriebfest**
- **Hoch-flexibel**
- **Schützt vor Unfällen**
- **Arbeitsdruck: max. 20 bar**
- **Berstdruck: 68 bar**

- High-Visible **SIGNAL** color
- Temp. range: from **-40°C till +65°C**
- Abrasion-resistant outside cover
- Ultra flexibility
- Improves workplace safety
- Working pressure: 300 PSI
- Break pressure: 1000 PSI

Nr. 297 214



Nr. 297 210

**Innen Ø 10mm**  
**Länge: 10m**

Inner Ø10mm (3/8")  
Length: 10m (32,8 ft)



3/8" - 10mm — **SIGNAL** — **MÜLLER-WERKZEUG** — **SIGNAL** — **MÜLLER-WERKZEUG**



**Hoch-flexibler Druckluftschlauch in gut sichtbarer SIGNAL Farbe.** Temperaturbeständig von -40°C bis +65°C. Extrem abriebfest. Die leuchtende SIGNAL Farbe fällt optisch sofort auf und verhindert Stolperunfälle. Arbeitsdruck max. 20 bar. Berstdruck: 68 bar. Länge 10m / 50m

**Nr. 297 210** **SIGNAL-Druckluftschlauch**  
Code: OE390000039  
**10m x 10mm ohne Kupplung**

**Nr. 297 214** **SIGNAL-Druckluftschlauch**  
Code: OE740000074  
**10m x 10mm mit Kupplung DE & Rückschlagdämpfung**

**Nr. 297 215** **SIGNAL-Druckluftschlauch**  
Code: OE168000168  
**50m x 10mm ohne Kupplung**

**Nr. 297 315** **SIGNAL-Druckluftschlauch**  
Code: OE248000248  
**50m x 13mm ohne Kupplung**



**High-visible & ultra flexible SIGNAL air hose.** The SIGNAL color helps to improve workplace safety. Working pressure: 300PSI. Break pressure: 1000PSI. Length: 10meters (32,8 ft) / 50meters (164,0 ft)

**SIGNAL Air hose 3/8", 10m**

**SIGNAL Air hose 3/8", 10m with coupling DE & safety nipple**

**SIGNAL Air hose 3/8", 50m**

**SIGNAL Air hose 1/2", 50m**

## STAHL-DRUCKLUFTKUPPLUNGEN EUROSTANDARD STEEL COUPLINGS



Die Druckluft-Stahlkupplungen weisen viele Vorteile gegenüber Standard-Messing-Kupplungen auf:

- Einhandbedienung mit geringer Kuppelkraft.
- Hohe Durchflussrate.
- Langlebigkeit durch oberflächenveredelte und gehärtete Komponenten mit engen Fertigungstoleranzen.

Durchfluss: 2.200 l/min., maximaler Betriebsdruck: 35 bar, Berstdruck: 150 bar.

**Verwendung:** Zur Leistungssteigerung, Verbesserung der Wirtschaftlichkeit und Erhöhung der Sicherheit von Industriedruckluftanlagen.

**Hinweis:** Entspricht Eurostandard 7.6 (Nenn-Ø 7,6mm, Euro-Profil) und ist kompatibel mit allen gängigen Systemen.



The Mueller pneumatic couplings have some advantages.

- low connection force
- high airflow
- long life based on high quality components

Air flow: 2.200l/min, max. pressure 35bar, break pressure 150bar



Improves efficiency and work safety.

Fits for all Euro-Standard (Euro-profile) 7.6mm

### Stahl-Druckluftkupplung / Steel Couplings

mit Außengewinde mit Gewindedichtung with outside thread	<b>1/4"</b> Nr. 400 001/S Code: OE178001780	<b>3/8"</b> Nr. 400 002/S Code: OE178001780	<b>1/2"</b> Nr. 400 003/S Code: OE178001780	
mit Innengewinde with inner thread	<b>1/4"</b> Nr. 400 004/S Code: OE178001780	<b>3/8"</b> Nr. 400 005/S Code: OE178001780	<b>1/2"</b> Nr. 400 006/S Code: OE178001780	
für Schlauch-Innen-Ø for hose inner-Ø		<b>10mm</b> Nr. 400 008/S Innen-/ inner-Ø Code: OE178001780	<b>13mm</b> Nr. 400 009/S Innen-/ inner-Ø Code: OE178001780	

### Industrie-Stahlnippel / Steel Nipples hardened

mit Außengewinde mit Gewindedichtung (5-tlg.) with outside thread (5pcs.)	<b>1/4"</b> Nr. 400 028/S/5 Code: OE198001980	<b>3/8"</b> Nr. 400 029/S/5 Code: OE198001980	<b>1/2"</b> Nr. 400 030/S/5 Code: OE198001980	
mit Innengewinde (5-tlg.) with inner thread (5pcs.)	<b>1/4"</b> Nr. 400 031/S/5 Code: OE198001980	<b>3/8"</b> Nr. 400 032/S/5 Code: OE198001980		
für Schlauch-Innen-Ø (5-tlg.) for hose inner-Ø (5pcs.)		<b>10mm</b> Nr. 400 015/S/5 Innen-/ inner-Ø Code: OE198001980	<b>13mm</b> Nr. 400 016/S/5 Innen-/ inner-Ø Code: OE198001980	

### Sicherheits-Stecknippel / Safety Nipple

Zum kontrollierten und langsamen Luftablass+Rückschlagdämpfung. / Releases the air controlled and slowly.

für Schlauch-Innen-Ø for hose inner-Ø	<b>10mm</b> Nr. 400 010/SR Innen- / inner-Ø Code: OE980000980	<b>13mm</b> Nr. 400 013/SR Innen- / inner-Ø Code: OE198001980	
--	---	---	---

### Schlauchklemmen für Druckluftschlauch / Hose Clamps for Air Hose

2-Ohr-Schlauchklemmen-Set (10-tlg.) Hose-Clamp-Kit (10pcs.)	<b>14-17mm</b> Nr. 400 044/10 Außen-/Outer-Ø 10mm Innen-/inner-Ø Code: OE14000014	<b>17-20mm</b> Nr. 400 047/10 Außen-/Outer-Ø 13mm Innen-/inner-Ø Code: OE14000014	
--	--	--	---

Druckluft-Werkzeuge  
Power Tools  
1  
Fahrwerk  
Suspension  
2  
Brems- & Rad  
Brake & Wheel  
3  
Motor  
Engine-Tools  
4  
Zerspanung  
Cutting Tools  
5  
Karosserie/Verschleiß  
AutoBody/Consumables  
6  
Universal-Werkzeuge  
Universal Tools  
7  
Transporter & LKW  
Heavy Duty & Trucks  
8  
Equipment  
9  
Inhaltsverzeichnis  
Table of Contents

## STECKNUSS-SATZ FÜR ALUFELGEN SOCKET SET FOR ALUMINIUM RIMS

TOOL-INNOVATION  
1998



**Größen: SW17, 19 + 21 x 1/2"**  
Sizes: 17, 19 + 21mm x 1/2"

**Kunststoffanschlag zum Schutz der  
verchromten Radbolzen/Radmuttern**  
Plastic inlay for the protection of the wheel  
bolts and wheel nuts

**Schlagschrauberfest**  
Impact wrench proof



**Hochwertige, dünnwandige Schlagstecknüsse** zur beschädigungsfreien De- und Montage von Aluminiumfelgen in der Fachwerkstatt. Kunststoffhülse zum Schutz der Felge. Kunststoffanschlag innen zum Schutz von verchromten Radbolzen. Die einzelnen Größen SW17, 19, 21 sind durch unterschiedlichen Farbcode zu erkennen. Länge 80mm-

**Nr. 800 100 Stecknuss-Satz für Alufelgen**  
Code: OE360000036



**High-quality, thin-walled impact sockets** for the damage-free removal and mounting of aluminium rims in specialist workshops. Plastic sleeve for the protection of the rim. The individual sizes wrench opening 17, 19, 21 are colour-coded. Length: 80mm.

**Socket set for aluminium rims**

## XL-RADMONTAGE-STECKNUSS-SATZ XL WHEEL MOUNTING SOCKET KIT

TOOL-INNOVATION  
2004



**Größen: SW17, 19 + 21 x 1/2"**  
Sizes: 17, 19, 21mm x 1/2"

**Extra lange und dünnwandige Ausführung**  
Extra long and thin walled design



**Hochwertige extra lange, dünnwandige Ausführung** aus einem Stück. Zur ergonomisch optimalen De- und Montage von Rädern in der Fachwerkstatt. Größen sind durch unterschiedlichen Farbcode zu erkennen.

**Nr. 800 200 XL-Radmontage Stecknuss-Satz 3-tlg.**  
Code: OE790000079



**High-quality, extra long, thin-walled single-piece design.** Ergonomic design for removal and mounting of wheels in specialist workshops. For use with Torque Wrench! The individual sizes are colour-coded.

**XL wheel mounting socket kit 3 pcs.**

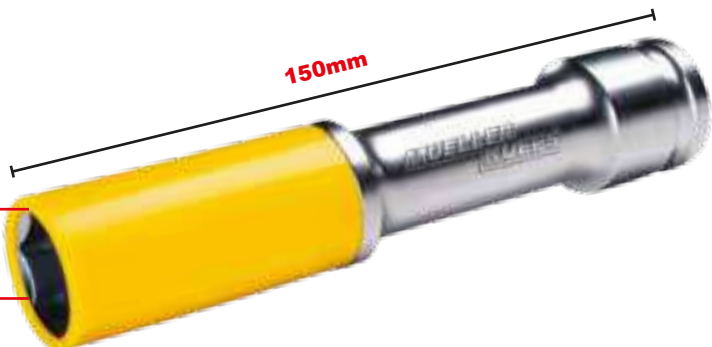

## DIESELFILTER-FÜLLGERÄT V2 DIESEL FILTER FILLER V2



Zum schnellen, sauberen und problemlosen Entlüften (Befüllen) der Dieselfilter sämtlicher Fahrzeuge. Beim Filterwechsel, leergefahrenem Tank, falsch getankt...

Mit Betätigung des Hebels wird ein Vakuum im Dieselfilter-Füllgerät erzeugt. Dieses Vakuum wird durch die Spezialschläuche an den Dieselfilter "weitergegeben". Somit wird vom Tank her der Kraftstoff angesaugt. **Ergonomische Entleerung, integriertes Vakuum-Manometer. Vakuumstärke stufenlos regulierbar.** Durch die verschiedenen Schläuche universell passend.

**Anschluss am Vorlauf, vom Dieselfilter zum Motor.**

**Nr. 515 007/V2 Dieselfilter-Füllgerät**

Code: OE158000158



**Especially for quick, clean and problem free bleeding of diesel filter** (filling of the diesel filter).

Universal for all cars diesel filter changing, as for empty driven tank. Different hoses guarantee universal fitting. Connect at the line diesel to engine.

**Diesel filter filler**

## UNIVERSAL BREMSSEN-ENTLÜFTER UNIVERSAL BRAKE BLEEDER



**Durch das integrierte Venturisystem wird ein kraftvolles Vakuum erzeugt.** Universal-Nippel, auch für einige ABS Systeme geeignet.

Inhalt: 2 Liter, Höhe: 27cm

**Nr. 515 009/V2 Universal Bremsen-Entlüfter**

Code: OE168000168



**Works with the integrated venturi system. Produces a strong vacuum which bleeds the brake system.** With universal nipple, also fits for some ABS systems. 2 litre.

**Universal brake bleeder**



Druckluft-Werkzeuge  
 Power Tools  
 1  
 Fahrwerk  
 Suspension  
 2  
 Bremse & Rad  
 Brake & Wheel  
 3  
 Motor  
 Engine-Tools  
 4  
 Zerschneidung  
 Cutting Tools  
 5  
 Karosserie/Verschleiß  
 AutoBody/Consumables  
 6  
 Universal-Werkzeuge  
 Universal Tools  
 7  
 Transporter & LKW  
 Heavy Duty & Trucks  
 8  
 Equipment  
 9  
 Inhaltsverzeichnis  
 Table of Contents

## DRUCKLUFT-BREMSEN-RÜCKSETZER AIR BRAKE PISTON RESETTER



**Universelle Anwendung, passend auch für Müller 468 020 Adapterplatten.** Geeignet für Links- und Rechtsgewinde Bremskolben. Lieferung in Schaumstoffeinlage, 6-8bar.

**Nr. 468 026 Druckluft-Bremsen-Rücksetzer**

Code: OE198000198



**Universal use, fits also for Mueller 468 020 adapters.** Works for left and right threaded brake pistons. Includes foam inlay, 6-8bar.

**Nr. 468 026 Air brake piston resetter**

Code: OE198000198



## 3/4" IMPACT STECKNUSS SATZ SOCKET KIT



**Impact Stecknüsse einzeln erhältlich:**

Impact Sockets separately available:

**SW24, long**

Nr. 801 024  
Code: OE380000038

**SW30, long**

Nr. 801 030  
Code: OE380000038

**SW33, long**

Nr. 801 033  
Code: OE420000042

**SW41, long**

Nr. 801 041  
Code: OE580000058

**SW27, long**

Nr. 801 027  
Code: OE380000038

**SW32, long**

Nr. 801 032  
Code: OE420000042

**SW36, long**

Nr. 801 036  
Code: OE480000048

Nr. 807 005  
Code: OE440000044

**Impact Verlängerung 175mm  
Impact Extension 175mm**



**Gesenkgeschmiedet.** Lieferung in Schaumstoffeinlage. SW24, 27, 30, 32, 33, 36, 41 + Verlängerung 175mm

**Nr. 801 800 3/4" Impact Stecknuss Satz**

Code: OE188000188



**Drop forged.** Comes with foam inlay. 24, 27, 30, 32, 33, 36, 41mm + extension 175mm.

**Nr. 801 800 3/4" Impact Socket Kit**

Code: OE188000188

## ANTRIEBSWELLEN STECKNUSS SATZ 3/4" DRIVE SHAFT SOCKET KIT 3/4"



Für 12-kant Muttern z. B. auf Antriebswellen. Extra schwere Ausführung, Antrieb 3/4", Größen 24, 27, 30, 32, 34, 36mm. Lieferung in Schaumstoffeinlage.

**Nr. 801 806 Antriebswellen Stecknuss Satz 3/4"**  
Code: OE178000178



Impact version for 12-point nuts i. e. on the drive shafts. Extra heavy version, 3/4" drive. Includes with foam inlay.

**Nr. 801 806 Drive shaft socket kit 3/4"**  
Code: OE178000178

## XL-IMPACT ROHRSTECKNÜSSE XL-IMPACT SOCKETS



**Gesenkgeschmiedet aus einem Stück.** Speziell für die Zwillingbereifung an LKW's. 400mm x 3/4" Antrieb.

Nr. 805 024 XL-Impact Rohrstecknuss SW24  
Code: OE112000112

Nr. 805 027 XL-Impact Rohrstecknuss SW27  
Code: OE112000112

Nr. 805 030 XL-Impact Rohrstecknuss SW30  
Code: OE112000112

Nr. 805 032 XL-Impact Rohrstecknuss SW32  
Code: OE118000118



**Gesamtlänge: 400mm**  
Overall length: 400mm



**Fully massive drop forged.** Special made for the truck twin tires. 400mm x 3/4" drive.

XL-Impact socket SW24

XL-Impact socket SW27

XL-Impact socket SW30

XL-Impact socket SW32

## SCHLAG-VERLÄNGERUNGS-SATZ IMPACT LOCKING EXTENSION KIT



2tlg., 125 + 250mm, 1/2" Antrieb, mit Verriegelung. Ermöglicht einen sicheren und festen Sitz der Stecknuss.

**Nr. 807 020 Schlag-Verlängerungs-Satz**  
Code: OE480000048

Nr. 807 003 Schlag-Verlängerung 125mm x 1/2" mit Verriegelung  
Code: OE320000032

Nr. 807 004 Schlag-Verlängerung 250mm x 1/2" mit Verriegelung  
Code: OE380000038



2pcs, 125 + 250mm 1/2", with locking mechanism. Ensures safe and tight connection of the impact sockets.

**Impact locking extension kit**

Impact locking extension 125mm x 1/2"

Impact locking extension 250mm x 1/2"



Druckluft-Werkzeuge Power Tools  
1  
Fahrwerk Suspension  
2  
Bremsen & Rad Brake & Wheel  
3  
Motor Engine-Tools  
4  
Zerspanung Cutting Tools  
5  
Karosserie/Verschleiß AutoBody/Consumables  
6  
Universal-Werkzeuge Universal Tools  
7  
Transporter & LKW Heavy Duty & Trucks  
8  
Equipment  
9  
Inhaltsverzeichnis Table of Contents

## POLYGON-IMPACT GELENK SATZ POLYGON IMPACT JOINT KIT



**Spezielle Kugel mit Flächen garantiert maximale Kraftübertragung. Rastmechanismus.** Dadurch als Gelenk und starr einsetzbar. 1/4", 3/8", 1/2"

**Nr. 810 203 Polygon-Impact Gelenk Satz 3-tlg.**  
Code: OE68000068



**Special ball with flat areas ensures maximum torque transfer.** Works as joint and straight connector. 1/4", 3/8", 1/2"

**Nr. 810 203 Polygon Impact Joint Kit 3pcs.**  
Code: OE68000068



## IMPACT GELENKWELLEN 12-KANT-SATZ IMPACT AXLE SHAFT 12-POINT-KIT



**SW24, 27, 30, 32, 34 + 36**  
24, 27, 30, 32, 34 + 36mm

**12-kant Stecknüsse**  
12-point sockets

**Stecknüsse für Innen  
6-kant SW14, 17 +19**  
Hex sockets for inner profile  
14, 17 + 19mm

**Antrieb: 1/2",  
schlagschrauberfest**  
1/2", impact wrench proof

**Extra lange  
Ausführung: 85mm**  
Extra long version: 85mm



**Stecknuss Satz 9 tlg., Schlagausführung** speziell zum Lösen und Anziehen der 12-kant Muttern auf den Antriebswellen. Alle benötigten 12-kant Spezialstecknüsse SW 24, 27, 30, 32, 34, 36 x 1/2" Länge 85 mm für überstehende Gelenkwellegewinde. Lösen und Anziehen des Innen 6-kant Profiles in den Gelenkwellen. Innen 6-kant Stecknüsse SW 14, 17, 19 x 1/2", extra kurz, Länge 34 mm. Komplet in stabilen Kunststoff-Ordnungssystem

**Nr. 810 500/9 IMPACT Gelenkwellen 12-Kant-Satz, 9-tlg.**  
Code: OE128000128



**Lösen und Festziehen der  
Antriebswellenmuttern**  
Loose and tight axle shaft nuts



**Impact socket kit 12-point.** Especially made to loose and tight the axle shaft nuts. Hex sockets for the inner profile. Will be supplied with plastic storage.

**IMPACT Axle shaft 12-point-kit,  
9 pcs.**

## XS-STUBBY IMPACT SATZ EXTRA KURZ XS-STUBBY IMPACT SOCKET KIT 10-24MM ON RAIL



**28 mm**  
extra kurz  
extra short



Alle Nüsse einzeln erhältlich (siehe Preisliste). All parts separately available (see price list).



Ideal zur Verwendung an schwer zugänglichen Stellen durch die einzigartige extra kurze Bauhöhe. 15-tlg. Lieferung komplett auf Steckleiste.

**Nr. 810 700 XS-Stubby Impact Satz extra kurz, Antrieb 1/2" 10-24mm auf Leiste**  
Code: OE980000098



Ideal to access hard to reach areas based on the unique short construction. 15-pcs. Delivery on rail.

**XS-Stubby Impact socket kit 10-24mm on rail**

## DUO DRIVE®

### STECKNUSS-SATZ SOCKET KIT



Das **DUO DRIVE**® System ermöglicht den Einsatz verschiedener Schlagschrauber (z.B. 1/2", 3/4" etc.), sowie die Verwendung von Ring- und Maulschlüssel etc.

**Nr. 810 808 Stecknuss-Satz XZN-Impact, 8-tlg.**  
Code: OE880000088



The **DUO DRIVE**® is made to be used with 1/2" + 3/4" impact wrenches. As well you can use it with wrenches.

**Nr. 810 808 Socket kit XZN-impact 8 pcs.**  
Code: OE880000088

**Antrieb:**  
1/2" + SW24  
Drive:  
1/2" + 24mm

**Größen: M12, M14, M16, M18**  
Sizes: M12, M14, M16, M18

**Länge:**  
40mm  
Length:  
40mm

**Länge: 75mm**  
Length: 75mm



Vielzahl-Stecknuss einzeln erhältlich. Sockets are separately available.

<b>M12</b> <b>Nr. 810 812</b> Code: OE200000020	<b>M14</b> <b>Nr. 810 814</b> Code: OE220000022	<b>M16</b> <b>Nr. 810 816</b> Code: OE240000024	<b>M18</b> <b>Nr. 810 818</b> Code: OE260000026
<b>M12</b> <b>Nr. 810 822</b> Code: OE280000028	<b>M14</b> <b>Nr. 810 824</b> Code: OE300000030	<b>M16</b> <b>Nr. 810 826</b> Code: OE320000032	<b>M18</b> <b>Nr. 810 828</b> Code: OE340000034

## DRUCKLUFT-WARTUNGSKIT AIR TOOL SERVICE KIT



Für hochwertige Druckluftwerkzeuge. Motor täglich ölen, Schlagwerk regelmäßig fetten.

**Nr. 906 023 Druckluft-Wartungskit**  
Code: OE360000036



For high-end air tools, don't forget the right accessories.

Oil daily the air motor, use grease when needed for the hammer mechanism.

**Air tool service kit**



Druckluft-Werkzeuge  
Power Tools  
1  
Fahrwerk  
Suspension  
2  
Bremsen & Rad  
Brake & Wheel  
3  
Motor  
Engine-Tools  
4  
Zerspanung  
Cutting Tools  
5  
Karosserie/Verschleiß  
AutoBody/Consumables  
6  
Universal-Werkzeuge  
Universal Tools  
7  
Transporter & LKW  
Heavy Duty & Trucks  
8  
Equipment  
9  
Inhaltsverzeichnis  
Table of Contents





**MÜLLER Tipp:**  
elektronisches Dokument  
Artikelsuche mit "Strg + F"

**MUELLER Tip:**  
electronic document  
Product Search "Ctrl + F"

**Apple:** "⌘ + F"

# FAHRWERK SUSPENSION



Fahrwerk  
Suspension **2**

Bremse & Rad  
Brake & Wheel **3**

Motor  
Engine-Tools **4**

Zerspanung  
Cutting Tools **5**

Karosserie/Aerschleiß  
AutoBody/Consumables **6**

Universal-Werkzeuge  
Universal Tools **7**

Transporter & LKW  
Heavy Duty & Trucks **8**

Equipment **9**

**LKW-HEBELEISEN**  
**HEAVY DUTY PRY BAR**

**Schlagfester, ergonomischer Griff**  
Ergonomic and hammer resistant



**610mm x 90°**  
**Nr. 276 301**  
Code: OE62000062

**Sonderstahl, gehärtet und vergütet**  
Special steel, hardened and tempered



**910mm x 45°**  
**Nr. 276 302**  
Code: OE68000068



**610mm x 60°**  
**Nr. 276 303**  
Code: OE68000068

**Nr. 276 310**  
**LKW-Hebeleisensatz, 4-tlg.**  
Heavy duty pry bar kit, 4 pcs.



**900mm**  
**Nr. 276 304**  
Code: OE68000068



**Massiver Schlagkopf**  
Massiv punch head

**45° Sonderstahl-Klinge**  
45° special steel

**1130mm, 6-kant, gehärtet und vergütet**  
1130mm, hex, coated and hardened

**Gesamtlänge: 1150mm** Length: 1150mm

**Ergonomischer "DUO-GRIFF"**  
Ergonomic "DUO-HANDLE"

**Nr. 276 342**  
**LKW-Hebeleisen "DUO-GRIFF"**  
Heavy duty pry bar "DUO HANDLE"



**Nr. 276 340**  
Code: OE68000068  
**Wandhalterung für Hebeleisen**  
(ohne Werkzeuge)  
Steel wall rack (without tools)



**Schlagfester, ergonomischer Kunststoffgriff**, ausgelegt zur Arbeit mit 2 Händen. Durchgehende 4-Kant Sonderstahlklinge 16x16mm mit massivem Schlagkopf für höchste Beanspruchung. Gehärtet und vergütet, nachschleifbar.

**Nr. 276 310 LKW-Hebeleisen-Satz, 4-tlg.**  
Code: OE198000198

**Nr. 276 342 LKW-Hebeleisen "DUO-GRIFF"**  
Code: OE138000138



**Ergonomic, hammer resistant handle** for 2-hand use. Special steel 16x16mm going through handle, massive punch head for toughest daily work. Made for heavy duty jobs as truck, offshore....

**Heavy duty pry bar kit, 4 pcs.**

**Heavy duty pry "DUO HANDLE"**

Fahrwerk  
Suspension

2

Bremse & Rad  
Brake & Wheel

3

Motor  
Engine-Tools

4

Zerspanung  
Cutting Tools

5

Karosserie/Verschleiß  
AutoBody/Consumables

6

Universal-Werkzeuge  
Universal Tools

7

Transporter & LKW  
Heavy Duty & Trucks

8

Equipment

9

Inhaltsverzeichnis  
Table of Contents

# GELENKKOPF-HEBELEISEN SWIVEL HEAD PRY BAR



**Universell einsetzbares Hebelwerkzeug.** Gelenk-Schwenkopf in zahlreiche Positionen verstellbar. Schmales Profil ermöglicht den Einsatz der Hebeleisen an engen und schwer zugänglichen Stellen. Perfekte Einstellmöglichkeiten je nach Anforderung. Integrierter Ratschenmechanismus

**Nr. 276 321** **Schweres Teleskop-Hebeleisen 530-840mm**  
Code: OE168000168

**Nr. 276 323** **Schweres Teleskop-Hebeleisen 760-1270mm**  
Code: OE198000198

**Nr. 276 500** **Gelenkkopf-Hebeleisen-Satz, 3-tlg. 240, 320 + 390mm**  
Code: OE112000112

**Nr. 276 504** **Gelenkkopf-Hebeleisen XL, 620mm**  
Code: OE980000098

**Nr. 276 505** **Gelenkkopf-Hebeleisen XL, 880mm**  
Code: OE114000114

**Nr. 276 513** **Doppelgelenk-Hebeleisen 380mm**  
Code: OE680000068



**Universal pry bar.** Swivel head is adjustable in many positions. Useable for tight and difficult reachable spots. Perfect tool for users.

**Heavy duty extendable pry bar 530-840mm**

**Heavy duty extenable pry bar 760-1270mm**

**Swivel head pry bar kit, 3 pcs. 240, 320 + 390mm**

**Swivel head pry bar XL, 620mm**

**Swivel head pry bar XL, 880mm**

**Double-joint pry bar 380mm**

## UNIVERSAL REINIGUNGSSET FÜR KONTAKTFLÄCHEN AIR ANGLE GRINDER KIT



Nr. 111 812

**optional**  
**Mini Lamellenscheiben**  
Ø 50mm, 10er Pack  
Mini flap disc Ø 50mm, 10pack

**Nr. 111 550/K40 Körnung K40**  
Code: OE290000029 grid K40

**Nr. 111 550/K60 Körnung K60**  
Code: OE290000029 grid K60

**Nr. 111 550/K80 Körnung K80**  
Code: OE290000029 grid K80

MÜLLER-WERKZEUG Technische Daten / technical information		
Gewicht / weight	Kg	0,50
Länge / length	mm	120
Anschlussgewinde / air nipple	Zoll	1/4"
Schlauchanschluss / air hose	mm	9-13
Luftverbrauch / air consumption	l/min	250
Drehzahl/min / rpm	Rpm	15000
Arbeitsdruck / air pressure	bar	6,2
Geräuschpegel / sound level	dBA	85



Nr. 111 816  
Code: OE128000128

**2-stufig,**  
**8.000 / 15.000 U/min**  
2-steps,  
8.000 / 15.000 RPM



### Einzelteile / spare parts:

**grobe Körnung**  
rough grain



Nr. 111 050  
Code: OE2900000290

**extra grobe Körnung**  
extra rough grain



Nr. 111 050/PUR  
Code: OE3900000390

**feine Körnung**  
fine grain



Nr. 111 360  
Code: OE980000980

**mittlere Körnung**  
medium grain



Nr. 111 350  
Code: OE980000980

**grobe Körnung**  
rough grain



Nr. 111 350/PUR  
Code: OE980000980



**Ergonomischer Winkelschleifer, 2-stufig.** Optimale Handhabung durch 70° Winkelstellung. 2-stufig, 8.000 / 15.000U/min. Schnellwechselschleifteller Ø 50mm. Passend für Roloc-System zum Schleifen, Entgraten, Polieren und Finishen. Zum Beispiel für Radnaben etc. 16-tlg.

**Nr. 111 812 Universal Reinigungsset für Kontaktflächen, 16-tlg.**  
Code: OE198000198



**Ergonomic angle grinder.** 70° angle head for optimized use. 2-step, 8000 / 15.000RPM. Quick-change pad Ø 50mm. Fits for Roloc-system sanding pad. Max speed: 15.000RPM. 16 pcs. kit.

**Air Angle Grinder Kit, 16 pcs.**

Fahrwerk  
Suspension

2

Bremse & Rad  
Brake & Wheel

3

Motor  
Engine-Tools

4

Zerspanung  
Cutting Tools

5

Karosserie/Verschleiß  
AutoBody/Consumables

6

Universal-Werkzeuge  
Universal Tools

7

Transporter & LKW  
Heavy Duty & Trucks

8

Equipment

9

Inhaltsverzeichnis  
Table of Contents

## VIBRO-IMPACT® SYSTEM



<b>MÜLLER-WERKZEUG</b> Technische Daten / technical information		
<b>Antrieb / drive</b>	mm	10,2
<b>Gewicht / weight</b>	Kg	2,49
<b>Länge / length</b>	mm	292
<b>Anschlussgewinde / air nipple</b>	zoll	1/4"
<b>Schlauchanschluss / air hose</b>	mm	9-13
<b>Luftverbrauch / air consumption</b>	l/min	114
<b>Schläge/min / impacts/min</b>	Bpm	2200
<b>Arbeitsdruck / air pressure</b>	bar	6,2
<b>Geräuschpegel / sound level</b>	dBA	100

## VIBRO-IMPACT®



**Nr. 290 210**  
Code: OE29000029



**Nr. 290 220**  
Code: OE29000029



**Nr. 290 230**  
Code: OE46000046



**Nr. 290 241**  
Code: OE39000039



**VIBRO-IMPACT®** System-Werkzeug zum Lösen festsitzender Verbindungen. Der punktgenaue Schlag des extrem kräftigen Pressluft-Hammers hilft bei der Demontage von z.B. Kegelsitzverbindungen, Radlagern, Buchsen, festgerosteten Schraubverbindungen und wirkt unterstützend z.B. von Abzieh- und Silentwerkzeugen.

**Nr. 290 206 VIBRO-IMPACT® SYSTEM**  
Code: OE338000338

**VIBRO-IMPACT®** System-tool to loose tight connections. The high performance air hammer helps to disassemble e.g. conical seat connection, wheel bearing, bushes, rusted screw connections...

**VIBRO-IMPACT® SYSTEM**

**VIBRO-IMPACT® MEIßEL**  
**VIBRO-IMPACT® CHISELS**

**Kugelführung, Verdrehsicherung**  
Ball-guide, non-turn

**Aufnahme: 10,2mm**  
Shaft: 10,2mm

**VIBRO-IMPACT®**



Nr. 290 217

Nr. 290 218

Nr. 290 219



**VIBRO-IMPACT® Meißel**, verdrehsicher. In drei verschiedenen Ausführungen erhältlich: Karosserie-Trenn-Meißel, Flachmeißel und Halbrundmeißel. Aufnahme: 10,2mm.



**VIBRO-IMPACT® Chisel**, non turnable. Three different constructions: Sheet metal cutter, flat chisel and half round chisel. Shaft: 10,2mm

**Nr. 290 217 VIBRO-IMPACT® Blech-Trenn-Meißel**  
Code: OE380000038

**VIBRO-IMPACT® sheet metal cutter**

**Nr. 290 218 VIBRO-IMPACT® Flach-Meißel**  
Code: OE380000038

**VIBRO-IMPACT® chisel separator**

**Nr. 290 219 VIBRO-IMPACT® Halbrund-Meißel**  
Code: OE380000038

**VIBRO-IMPACT® half round**

**Nr. 290 214 VIBRO-IMPACT® Austreiber 6,5mm**  
Code: OE430000043  
**VIBRO-IMPACT® pin 6.5mm**



Nr. 290 236 Austreiber 8mm geschmiedet mit Zentrierkopf  
Code: OE380000038  
Pin driver 8mm, drop forged, center head

Nr. 290 237 Austreiber 10mm geschmiedet mit Zentrierkopf  
Code: OE380000038  
Pin driver 10mm, drop forged, center head

Nr. 290 238 Austreiber 12mm geschmiedet mit Zentrierkopf  
Code: OE380000038  
Pin driver 12mm, drop forged, center head

Nr. 290 239 Austreiber 12mm geschmiedet, Zylinderform  
Code: OE240000024  
Pin driver 12mm, drop forged, cylinder head

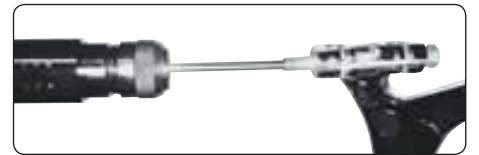

**Zum Trennen des inneren Auspuffrohres**  
To cut the inner tube



**Zum Trennen des äußeren Auspuffrohres**  
To cut the outside tube



**VIBRO-IMPACT® Auspuffmeißel-Satz, 2-tlg.**  
Zur Verwendung mit dem Druckluft-Hammer.



**VIBRO-IMPACT® exhaust chisel set, 2pcs.**  
For use with the air hammer.

**Nr. 403 120 VIBRO-IMPACT® Auspuffmeißel**  
Code: OE840000084

**VIBRO-IMPACT® exhaust chisel**

**KONKAV-AUSTREIBER**  
**CONCAVE HAMMER INSERT**



Schrauben und Bolzen werden durch die konkave Form perfekt zentriert. Länge 150mm.



Bolts and pins will be perfect centered through concave shape. Length 150mm.

**Nr. 290 231 Konkav-Austreiber**  
Code: OE360000036

**Concave hammer insert**



## VIBRO-IMPACT® SPURSTANGEN-GABEL VIBRO-IMPACT® FORK CHISEL

**Geschmiedet aus einem Stück**  
drop forged



32 mm



**VIBRO-IMPACT®** Spurstangen-Gabel zum Lösen festsitzender Spurstangen und Kegelsitzverbindungen. Passend für MÜLLER Drucklufthammer, Nr. 290 200. Aus einem Stück geschmiedet. (keine Schraubverbindung am Werkzeug)

**VIBRO-IMPACT®** fork chisel to loose tight conical seat-connections. Fits for MUELLER Air Hammer, no. 290 200. Drop forged.

**Nr. 290 226 VIBRO-IMPACT® Spurstangengabel 20mm**  
Code: OE640000064

**VIBRO-IMPACT® Fork Chisel 20mm**

**Nr. 290 227 VIBRO-IMPACT® Spurstangengabel 25mm**  
Code: OE680000068

**VIBRO-IMPACT® Fork Chisel 25mm**

**Nr. 290 228 VIBRO-IMPACT® Spurstangengabel 32mm**  
Code: OE780000078

**VIBRO-IMPACT® Fork Chisel 32mm**

## VIBRO-IMPACT® NADELENTROSTER VIBRO-IMPACT® NEEDLE SCALER

### VIBRO-IMPACT®



Kombi-Aufsatz für MÜLLER Drucklufthammer zur Entrostung und Farbentfernung.

**Nr. 290 245 VIBRO-IMPACT® Nadelentroster**  
Code: OE880000088



Additional unit to MUELLER Air Hammer for rust and paint removal.

**VIBRO-IMPACT® Needle Scaler**



## VIBRO-IMPACT® VERSCHRAUBUNGS-LÖSEWERKZEUG THREADED FASTENER / JOINT RELEASE TOOL



**Schnelles Lösen auch stark verrosteter Muttern** z. B. Spurstangen, Konterverschraubungen, Verschraubungen an Achskörpern usw. 190 mm lang. Bis max. SW22.

**Nr. 290 250 VIBRO-IMPACT® Verschraubungs-Lösewerkzeug**  
Code: OE168000168



**Quick release of heavily corroded nuts** e. g. on steering rods and bolted connections on axle bodies, etc. 190 mm long. Max. 22mm.

**Nr. 290 250 VIBRO-IMPACT® Threaded Fastener / Joint Release Tool**  
Code: OE168000168

**hochwertige Ausführung**  
quality design

**ergonomischer Handgriff**  
ergonomic handle



**XL-VIBRO-IMPACT® DRUCKLUFTHAMMER**  
**HEAVY DUTY VIBRO-IMPACT® AIR HAMMER**



**Der punktgenaue Schlag des extrem kräftigen Pressluft-Hammers hilft bei der Demontage** von z. B. Kegelsitzverbindungen, Radlagern, Buchsen, festgerosteten Schraubverbindungen und wirkt unterstützend z. B. von Abzieh- und Silentwerkzeugen.

**Nr. 290 300 XL-VIBRO-IMPACT® Drucklufthammer**

Code: OE698000698



**Heavy duty VIBRO-IMPACT® air hammer to loose tight connections at trucks, agricultural, construction etc.** The high performance air hammer helps to disassemble e. g. conical seat connections, wheel bearings, bushes, rusted screw connections. Can support as well pullers.

**Nr. 290 300 Heavy Duty VIBRO-IMPACT® Air Hammer**

Code: OE698000698

<b>MÜLLER-WERKZEUG</b> Technische Daten / technical information		
<b>Antrieb / drive</b>	mm	15mm 6-Kant / HEX
<b>Gewicht / weight</b>	Kg	5,40
<b>Länge / length</b>	mm	380
<b>Anschlussgewinde / air nipple</b>	Zoll	3/8"
<b>Schlauchanschluss / air hose</b>		13 mm / 1/2"
<b>Luftverbrauch / air consumption</b>	l/min	210
<b>Schläge/min / impacts/min</b>	BPM	2.500
<b>Arbeitsdruck / air pressure</b>	bar	6,2



**Nr. 290 318**



**Nr. 290 338**

Nr. 290 318 **XL-VIBRO-IMPACT®** Flachmeißel, 6-kant Schaft  
Heavy Duty **VIBRO-IMPACT®** flat chisel

Nr. 290 338 **XL-VIBRO-IMPACT®** Austreiber 20mm, 6-kant Schaft  
Heavy Duty **VIBRO-IMPACT®** pin driver 20mm

Nr. 290 310 **XL-VIBRO-IMPACT®** Spurstangen, 6-kant Schaft  
Heavy Duty **VIBRO-IMPACT®** tie rod

Nr. 290 320 **XL-VIBRO-IMPACT®** Hammer 6-kant Schaft  
Heavy Duty **VIBRO-IMPACT®** hammer

Nr. 290 331 **XL-VIBRO-IMPACT®** Konkav 6-kant Schaft  
Heavy Duty **VIBRO-IMPACT®** concave



**Nr. 290 310**

**Nr. 290 320**

**Nr. 290 331**





## FEDERBEIN-SPANNZANGE SPRING AND SHOCK ABSORBER STRUT VICE



**Zum problemlosen Spannen von Federbeinen.** Federbeinrohre werden nicht verdrückt. Leichtes Arbeiten in Verbindung mit dem Stoßdämpfersatz. Universell geeignet. Zur Verwendung im Schraubstock oder zum Anschrauben an die Werkbank.

Schließen und Spannen mit nur einer Hand möglich.

### Nr. 430 001 Federbein-Spannzange

Code: OE168000168



**Suspension strut clamping jaws**, for the trouble-free clamping of suspension struts. Suspension struts tubes are no longer crushed. Easy to use in connection with the shock absorber set. Universally applicable. For use in a vice or can be screwed on the workbench. Can be closed and opened with one hand only.

### Nr. 430 001 Spring and absorber strut vice

Code: OE168000168



## STOSSDÄMPFER-MONTAGEEINHEIT MOUNTING UNIT FOR SHOCK ABSORBER



**Zur Montage der neuartigen Stoßdämpfer mit integrierter Zuganschlagsfeder** ist diese Montageeinheit zwingend erforderlich. Sichere, schnelle und einfache Handhabung. Universell anwendbar z.B. bei folgenden Fahrzeugtypen: Mercedes, BMW, Ford, Toyota, Peugeot, Fiat etc. Geeignet für verschiedene Stoßdämpfer-Hersteller, z. B. SACHS. Hohe Zeitersparnis, Bedienung durch nur eine Person.

### Nr. 431 020 Stoßdämpfer-Montageeinheit

Code: OE278000278

Nr. 431 022

Uni-Klemmstück

Code: OE620000062



**For the easy and safety mounting** of suspensions with inner-spring. Can use for e.g. BMW, Mercedes, Toyota, Peugeot, Fiat, Ford etc. Fits for different suspensions, e.g. SACHS etc.

### Nr. 431 020 Mounting unit for shock absorber

Code: OE278000278

Nr. 431 022

Uni-Clamp

Code: OE620000062



## UNIVERSAL RADLAGER-WERKZEUG UNIVERSAL WHEEL BEARING TOOL



**Spezialmutter mit Drucklager**  
Hex nut of bearing remover kit

**Spindel TR20**  
Spindle TR20



**Glockenring Ø 75 + 85mm**  
Housing ring Ø 75 + 85mm

**Druckscheiben Ø 55, 61, 63, 67, 71,5 + 82mm**  
Pressure discs Ø 55, 61, 63, 67, 71,5 +82mm

**Radnaben-Abdrückbolzen**  
**M12x1,5; M14x1,5**  
Pressure bolt M12x1,5; M14x1,5



**Glockengrundplatte**  
Stepped basic disc

**Adapterring**  
Adapterring

**Ersatzteile siehe Preisliste.**  
Spare parts see price list.



**Universell anwendbarer Radlagersatz** zur Demontage und Montage von Rad-Flansch und Rad-Lager ohne Ausbau der Federbeine. Anwendung direkt am Fahrzeug. Komplett mit allen Scheiben, Ringen, Abdrückbolzen für Radnaben, Spezial Spindelfett etc. Alle Teile auch einzeln lieferbar. Lieferung im stabilen Kunststoffkoffer zur sicheren Aufbewahrung. Absolut universelle Anwendung. Ersatzteile siehe Preisliste.

**Nr. 432 001 Universal Radlager-Werkzeug**

Code: OE267000267



**Universal wheel bearing** set for the assembly and disassembly of wheel flange and wheel bearing without dismantling the suspension struts. Direct on-vehicle application, complete with all discs, rings, forcing bolts, for wheel hubs, special spindle grease, etc. All parts individually available. Delivery in a strong plastic case for safe storage. Absolutely universal application. Spareparts please see price list.

**Universal wheel bearing tool**

## DOPPEL-KONUS RADLAGERWERKZEUG TWIN-CONE WHEEL BEARING KIT



Neuartiges Prinzip für geschraubte Radlager. Auch universell anwendbar für nahezu alle Radlager.

**Nr. 432 005 Doppel-Konus Radlagerwerkzeug**  
Code: OE198000198



New principle for the screwed wheel bearings. Fits as well universal for nearly all other wheel bearings.

**Nr. 432 005 Twin-cone wheel bearing kit**  
Code: OE198000198

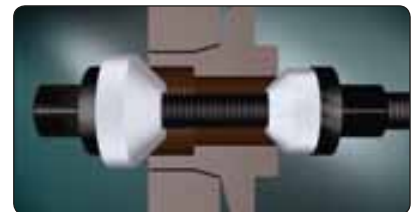
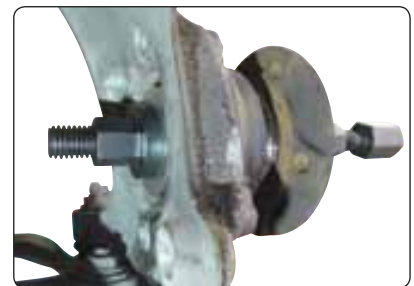
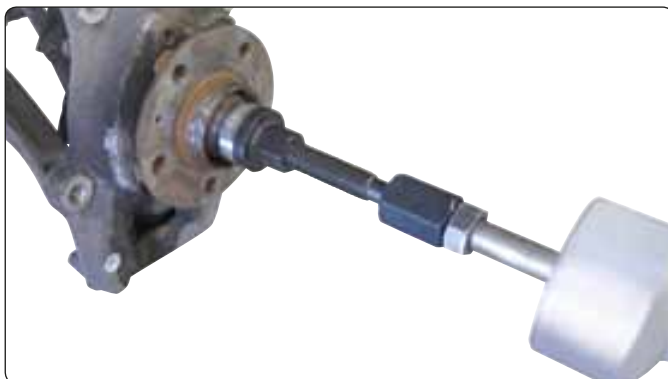

**RADLAGERWERKZEUG VW LAGER / NABENEINHEIT  
VW HBU (HUB-BEARING UNIT) WHEEL BEARING KIT**



Lager Ø 72mm z.B. VW Polo ab Bj.02, Skoda Fabia ab Bj.00



Lager Ø 66mm z.B. Audi A2 ab Bj.00, VW Polo ab Bj.02, VW Fox ab Bj.05, Skoda Fabia ab Bj.00, Seat Ibiza ab Bj.02



Lager Ø 62mm z.B. Audi A2 1,2L., VW Lupo



**Zur Montage der neuartigen Radlager** (Lager / Naben-  
einheit). Anwendung direkt am Fahrzeug. Für alle Fahrwerke  
geeignet mit Lager Ø 62, 66 + 72mm. Auch für baugleiche  
Konzernfahrzeuge wie Seat, Skoda, Audi. Made in Germany.

**Nr. 432 012 VW Radlagerwerkzeug  
Kompaktlager (HBU)**  
Code: OE498000498



**For installing the new wheel bearing** (wheel hub/  
wheel bearing unit). Direct "on car" solutions. Fit for all chassis  
with bearing Ø 62, 66 + 72mm. Could be used also for Seat,  
Skoda, Audi from VW-Group etc. Made in Germany.

**VW Wheel bearing kit for HBU bearing**

# RADLAGERWERKZEUG LAGER / NABENEINHEIT HUB (HUB-BEARING UNIT) WHEEL BEARING TOOL



**Zur Montage der neuartigen Radlager** (Lager/ Nabeneinheit). Anwendung direkt am Fahrzeug. Für alle Fahrwerke geeignet mit Lager Ø 72mm.

**Nr. 432 014/M Radlagerwerkzeug Ø 72mm komplett**  
Code: OE298000298



**For installing the new wheel bearing** (wheel hub/ wheel bearing unit). Direct "on car" solutions. Fits for all chassis with bearing Ø 72mm.

**Nr. 432 014/M HBU wheel bearing kit Ø 72mm**  
Code: OE298000298



**Nr. 432 010-13**  
Code: OE118000118

**Glocke  
Cap**



**Nr. 432 001/05**  
Code: OE118000118

**Trapezgewinde-Spindel  
Spindle**



Lager Ø 62mm z.B.  
Audi A2 1,2L.,  
VW Lupo

**Nr. 432 010-11/M**  
Code: OE139000139

**Halbschalensatz für Ø 62mm Lager  
Adapter kit for wheel bearing Ø 62mm**



Lager Ø 72mm z.B.  
VW Polo ab Bj.02,  
Skoda Fabia ab  
Bj.00

**Nr. 432 010-12/M**  
Code: OE139000139

**Halbschalensatz für Ø 72mm Lager  
Adapter kit for wheel bearing Ø 72mm**



Lager Ø 66mm z.B.  
Audi A2 ab Bj.00,  
VW Polo ab Bj.02,  
VW Fox ab Bj.05,  
Skoda Fabia ab Bj.00,  
Seat Ibiza ab Bj.02

**Nr. 432 010-10/M**  
Code: OE139000139

**Halbschalensatz für Ø 66mm Lager  
Adapter for wheel bearing Ø 66mm**



Lager Ø 78mm z.B.  
FORD, VOLVO etc.

**Nr. 432 013**  
Code: OE168000168

**Halbschalensatz für Ø 78mm Lager  
Adapter kit for wheel bearing Ø 78mm**

**RADLAGERWERKZEUG VW T5**  
**WHEEL BEARING KIT VW T5**

**Einbau /** Mounting:

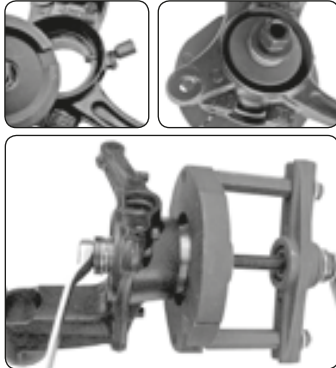

Nr. 432 015-1



Nr. 432 015-4



Nr. 432 015-5

Nr. 432 015-2  
**Einbau**  
mounting



Nr. 432 015-6

Nr. 432 015-7

Nr. 432 015-8

Nr. 432 015-3  
**Ausbau**  
dismounting



**Radlagerwerkzeug VW T5** zur Demontage und Montage der Radlager / Nabeneinheit ohne aufwendigen Ausbau der Federbeine. Anwendung direkt am Fahrzeug. Ersatzteile siehe Preisliste.

**Nr. 432 015 Radlagerwerkzeug VW T5**  
Code: OE748000748

**Nr. 432 016 Ergänzungssatz für 78mm HBU-Lager**  
Code: OE198000198



**Wheel bearing kit VW T5** for removing and installing the wheel hub / wheel bearing unit without dismantling the suspension struts. Direct on-vehicle application. Spareparts please see price list.

**Wheel bearing kit VW T5**

**Additional kit for 78mm HBU-bearing**

**SPRINTER RADLAGER-MONTAGE-WERKZEUG**  
**SPRINTER WHEEL BEARING MOUNTING KIT**



**Nr. EQ-432 015/Sprinter Radlager-Montage-Werkzeug**  
Code: OE648000648

**Wheel Bearing Mounting Kit**

## UNIVERSAL-RADLAGER-SATZ UNI WHEEL BEARING KIT



Passend für nahezu alle **Fahrzeuge mit Lager-Nabeneinheiten (Kompaktlager)** als auch mit **konventionellen Radlagern**.

**Sowohl für Demontage als auch Montage.**

Auch zur Verwendung mit Hydraulik-Hohlkolbenzylinder (Nr. 300 120) oder unter der Werkstattpresse.

Im Lieferumfang ist eine mechanische, schlagschrauberfeste Trapezgewindespindel enthalten. Lieferung im stabilen Koffer. Alle Teile auch einzeln verfügbar. Made in Germany.

**Nr. 432 030 Universal-Radlager-Satz**

Code: OE109801098



Suitable for almost all vehicles **with bearing hub units (compact bearings)** as well as with **conventional wheel bearings**.

**For disassembly as well as assembly.**

Also for use with hydraulic hollow piston cylinders (no. 300 120) or under the workshop press.

Supplied with a mechanical, impact wrench resistant, trapezoidal threaded spindle. Supplied in sturdy case. All parts are also available separately. Made in Germany.

**Nr. 432 030 Uni wheel bearing kit**

Code: OE109801098



## UNIVERSAL-RADLAGER-SATZ UNI WHEEL BEARING KIT

### Demontage / De-mounting

Anwendungsbeispiel: Lager-Nabeneinheiten / HBU  
Example of use: Bearing Hub Units / HBU

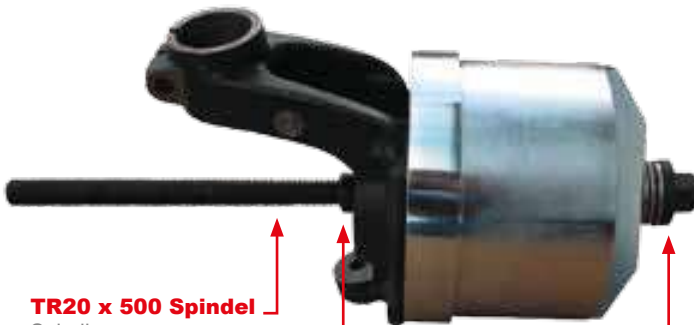

**TR20 x 500 Spindel**

Spindle  
Nr. 432 030-10

**Demontage-Konusdruckstück**

Cone-pressure piece  
Nr. 432 030-5

**3-Punkt Auszieh-Adapterring**

3-point adapter-ring  
Nr. 432 030-6

**Glocke**

Basic-unit  
Nr. 432 030-1

**TR20 Druckmutter**

Nut with bearing  
Nr. 609 420/TR20M

### Montage / Mounting

Anwendungsbeispiel: Lager-Nabeneinheiten / HBU  
Example of use: Bearing Hub Units / HBU

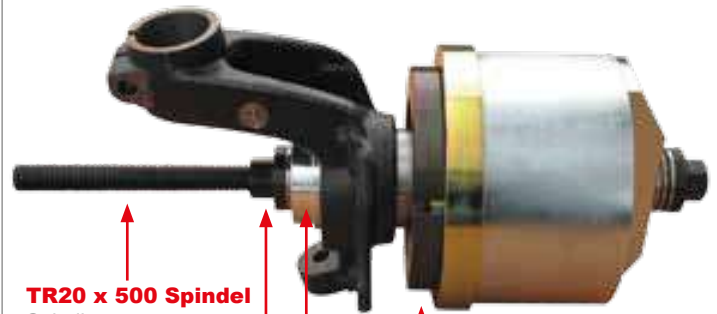

**TR20 x 500 Spindel**

Spindle  
Nr. 432 030-10

**TR20 Druckmutter**

Nut with bearing  
Nr. 609 420/TR20M

**Druckstück für Lager-Ø**

pressure disc for bearing-Ø  
62mm = Nr. 432 010-11/1/A  
66 + 72mm = Nr. 432 030-2  
78mm = Nr. 432 016-3  
82mm = Nr. 432 030-4  
85mm = Nr. 432 015-6

**Halbschalen-Satz für Lager-Ø**

Adapter-plate for bearing-Ø  
62mm = Nr. 432 010-11  
66 + 72mm = Nr. 432 010-12  
78mm = Nr. 432 010-14  
82mm = Nr. 432 030-3  
85mm = Nr. 432 015-2

**Glocke**

Basic-unit  
Nr. 432 030-1

**Adapterring**

Adapter-ring  
Nr. 432 030-7

NOTIZEN

NOTES



## RADLAGER-ABDRÜCKSATZ VW-GRUPPE WHEEL BEARING PULL KIT VW-GROUP



Zur Demontage der **geschraubten Radlager-/Naben-einheiten** aus dem Aluminiumgehäuse. Durch die Stahl/Aluminium Kombination sind diese Lager extrem festsitzend und korrodiert. Passend z. B. für Audi A4 ab 2000, A5 ab 2007, A6 ab '97, A7 ab '10, A8 ab '94, Q5 ab '08, Passat ab '03 sowie baugleiche Konzernfahrzeuge. Lieferung komplett im Koffer.

**Nr. EQ-432 037 Radlager-Abdrücksatz  
VW-Gruppe**  
Code: OE348000348



To remove the **bolt-connected hub/bearing** unit from aluminium multi link suspension units. Based on the Steel/Aluminum connection these bearings are extremely corroded and tight. Fits for Audi A4 '00-, A5 '07-, A6 '97-, A7 '10-, A8 '94-, Q5 '08-, Passat '03- and others from VW-group. Delivered completely in case.

**Wheel bearing pull kit VW-group**



## RADLAGER-PRESSWERKZEUG FORD TRANSIT FORD TRANSIT BEARING PRESS KIT



- **Zur De-/ und Montage des Radlagers von der Radnabe** unter der Werkstattpresse.
- **Zur Demontage des auf der Nabe verbleibenden Innenringes** mit exakt greifendem Halbschalensatz.
- Passend für 5+6 Loch Radnaben.

**Nr. 432 044 Radlager-Presswerkzeug  
FORD Transit 2000-2013**  
Code: OE398000398



**Successful removal** of troublesome inner bearing race and reinstallation of complete bearing assembly. For the removal and installation of the front wheel bearing on FORD Transit from 2000 - 2013 with the aid of a workshop press. Removes and installs bearings on both 5 and 6 stud hubs. Removes the inner and outer bearing race.

**FORD Transit Bearing Press Kit**



**FORD TRANSIT BREMSSCHEIBEN-TRENNWERKZEUG**  
**FORD TRANSIT REAR DISC SEPARATOR KIT**



**5-Punkt Auflageplatte zum problemlosen Trennen** der Hinterachs-Bremsscheibe von der Radnabe. Die oft extrem festsitzende Bremsscheibe kann zeitsparend mittels Werkstatt-presse ausgepresst werden. Passend für Transit ab Bj. 2000.

**Nr. 432 045 FORD Transit**  
**Bremsscheiben-Trennwerkzeug**  
Code: OE278000278



**Press solution for removing** the rear disc from the bearing hub. The hub bearings on this type of Transit often seize in place, requiring extreme force to separate. Suitable for Transit 2000 onwards (where rear discs are fitted -5 stud)

**FORD Transit Rear Disc Separator Kit**

**LAGERRINGAUSTREIBER PKW**  
**BEARING REMOVER CARS**



**Gesamtlänge: 300mm**  
Length: 300mm



**Rändelgriff**  
Anti slip grip

**Zum Ausschlagen von festsitzenden Lagerschalen.** Speziell geeignet für die äußeren Ringe der zweigeteilten Kegelrollenlager in den Radnaben.

**Nr. 432 200 Lagerringaustreiber**  
**PKW**  
Code: OE4350004350



**For removing tight fitting bearing rings.** Especially good for removing the two-part cone bearings inside the wheel hubs.

**Bearing remover cars**

**Speziell geeignet für zweigeteilte Kegelrollenlager**  
Especially for the two pieces bearings

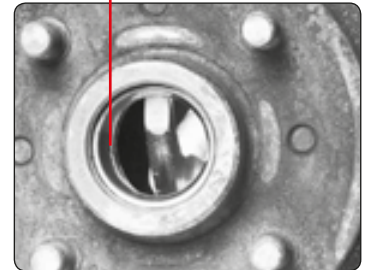

**LAGERRINGAUSTREIBER LKW, 500mm**  
**BEARING REMOVER HEAVY DUTY, 500mm**



**Gesamtlänge: 500mm**  
Length: 500mm



**Zum Ausschlagen von festsitzenden Lagerschalen.** Speziell geeignet für die äußeren Ringe der zweigeteilten Kegelrollenlager in den Radnaben.

**Nr. 432 500 Lagerringaustreiber**  
**LKW, 500mm**  
Code: OE580000058



**For removing tight fitting bearing rings.** Especially good for removing the two-part cone bearings inside the wheel hubs.

**Bearing remover heavy duty, 500mm**



## UNIVERSAL DRUCKSTÜCKSATZ UNIVERSAL PRESS DISC KIT

**Reduzierringe ø:  
80, 100, 120 mm**

Reducing ring Ø:  
80, 100, 120mm

**Aufnahmering  
z.B. zum Auflegen von  
Achsschenkeln:  
ø A130 x l 110 mm**

Receiver ring e.g. for axle  
stubs Ø:  
OD 130 x ID 110mm

**Druckscheiben ø: 60, 65, 68, 70, 72, 74, 77, 80, 82, 85 mm**

Pressure washers Ø: 60, 65, 68, 70, 72, 74, 77, 80, 82, 85 mm

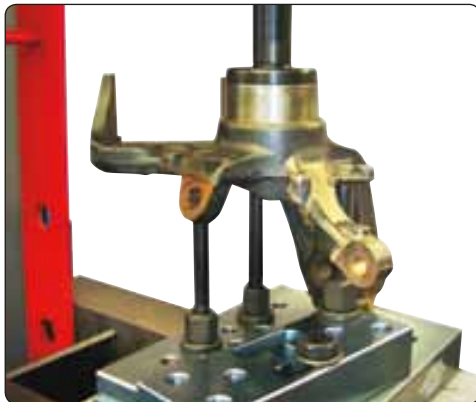

**Universal-Werkzeugsatz zum Aus- und Einpressen**  
von Radlagern, Buchsen, Simmerringen etc. Bestehend aus  
diversen Druckscheiben, Unterlegerringen, Distanzscheiben,  
Druckbolzen. Lieferung komplett im Koffer.

**Nr. 432 600 Universal Druckstücksatz**

Code: OE288000288



**Universal tool set for the pressing in and out** of wheel  
bearings, bushings, shaft seals etc. Kit consists of diverse  
pressure washers, ring washers, spacer rings, pressure pins.  
Supplied completely in a case.

**Universal press disc kit**

**UNI-PRESS-UNTERLAGE**  
**UNI-PRESS-SUPPORT**



**Höhenverstellbare Auflagebolzen**  
Adjustable anvil bolts

**Schwenkelement gewährleistet einfache Handhabung**  
Swivel element guarantees easy use



Nr. 432 650 + 609 390



WATCH DEMO HERE:



**3-Punkt Auflage, wackel- und spielfrei**  
3-point contact, non swivelling

**Sicherheitsführung für Presstisch**  
Safety alignment for workshop-press



**Universal-Auflageplatte** zur Verwendung an Werkstattpressen. Für Demontage- und Montagearbeiten. Durch Universal 3-Punkt Auflage wird eine wackel- und spielfreie Auflage gewährleistet.

**Nr. 432 650 Uni-Press-Unterlage**  
Code: OE298000298



**Universal-support** for use at workshop press. For demounting and mounting jobs. 3-point contact guarantees a perfect, non swivelling and save support.

**Uni-press-support**

Fahrwerk Suspension  
2  
Brems- & Rad Brake & Wheel  
3  
Motor Engine-Tools  
4  
Zerspanung Cutting Tools  
5  
Karosserie/Verschleiß AutoBody/Consumables  
6  
Universal-Werkzeuge Universal Tools  
7  
Transporter & LKW Heavy Duty & Trucks  
8  
Equipment  
9  
Inhaltsverzeichnis Table of Contents

## PRISMENPLATTEN PRESS PLATES



**Zur Verwendung am Pressentisch.**  
Gehärtet und vergütet.

**Nr. 432 700 Prismenplatte 4mm, extra dünn**  
Code: OE78000078  
Auch mit 2-Arm-Abzieher verwendbar.  
Für sehr enge Zwischenräume bis 4 mm.

**Nr. 432 701 Prismenplatte 250x200x20mm**  
Code: OE198000198

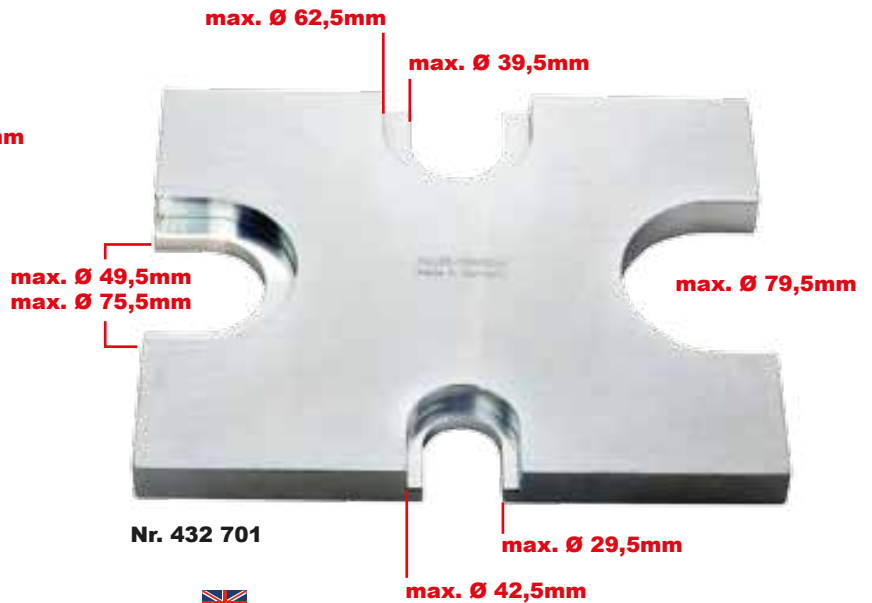

**For use at hydraulic workshop press.**  
Special heat treated.

**Press plate 4mm, extra thin**  
Can also be used with puller.

**Press plate 250x200x20mm**

## UNIVERSAL PRESS RING



Sichere massive Ringauflage bis zu 50 ton. Auch zur Anwendung z. B. mit unserer Universal-Pressplatte 432 650. Innendurchmesser 159mm, Höhe 160mm, Gewicht: 7,8kg Hilfreich zum Auspressen von Radlagern. Gute Alternative auch zu V-Blöcken.

**Nr. 432 711 Universal Press Ring 20ton.**  
Code: OE980000098



To be used in conjunction with the Universal Press Plate Nr. 432 650. This tool will help you pressing out wheel bearings by holding the hubs.

A large diameter ring (159mm) sits across the press plate allowing large hubs to be placed on the ring. Great alternative to V blocks and having to stack multiple items to create an unstable support for your press.

**Universal Press Ring**

Fahrwerk / Suspension  
 2  
 Bremse & Rad / Brake & Wheel  
 3  
 Motor / Engine-Tools  
 4  
 Zerschneidung / Cutting Tools  
 5  
 Karosserie/Verschleiß / AutoBody/Consumables  
 6  
 Universal-Werkzeuge / Universal Tools  
 7  
 Transporter & LKW / Heavy Duty & Trucks  
 8  
 Equipment  
 9

**PATENTIERT**

**Gesenkgeschmiedeter Haken**  
 Drop forged hook

**2-fach höhenverstellbar**  
 2-times on high adjustable

**Rutschfester Griff**  
 Anti-slip grip

**6-fach längenverstellbar**  
 6-times lengthwise adjustable

**Verstellbolzen**  
 Adjusting pin

**UNIVERSAL  
 ACHSHEBEL**  
**UNIVERSAL AXLE BAR**



**Zur Demontage von Kugelgelenken,** Querlenkern und weiteren Achsteilen. Universelle Anwendung, drehbar und mehrfach verstellbar. Querlenker, die unter Spannung stehen, können einfach + sicher nach unten gedrückt werden. Extrem festsitzende Querlenker lassen sich mit dem Universal Achshebel kraft- und zeitsparend von der Radaufhängung lösen. Auch Federbeine und viele Achsteile können demontiert werden.

**Nr. 432 900 Universal Achshebel**  
 Code: OE198000198



**For demounting the lower suspension arm,** ball joint... Universal use, turnable, different hook positions. For lowering of the suspension arms and separation of suspension components. Reduced effort required, due to unique design using leverage and body weight.

**Universal axle bar**

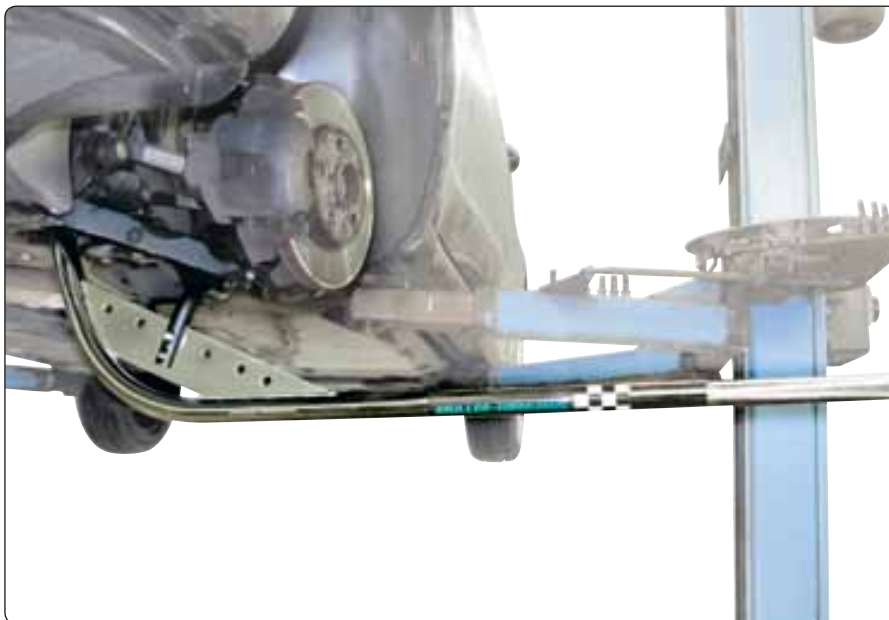

## MÜLLER-ACHS- UND RADSPIELPRÜFER MUELLER-SUSPENSION WEAR INDICATOR



**Domlager**  
Suspension strut support

**Stabilisator**  
Stabilizer bar

**Radlager**  
Wheel bearing

**Traggelenk**  
Suspension joint

**Lenkgetriebe**  
Steering gear

**Silentlager**  
Silent blocks

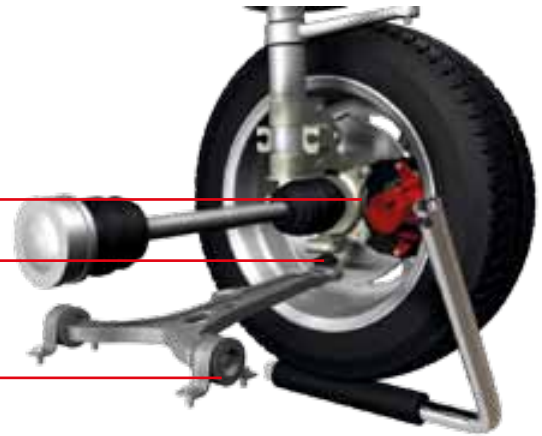

**TOOL-INNOVATION**  
2012



**Der Achsspielprüfer ist ein einfaches, aber sehr effektives Hilfsmittel** zur Lokalisierung von Störquellen (ausgeschlagene Verbindungen, ACHSSPIEL)

- Spiel- und Fehlerdiagnose bei belasteten Achsen wie im Fahrzustand
- Sicht-, Hör- und Tastprüfung
- Fehlerdiagnose z. B.: Radlager, Traggelenk, Axialgelenk, Domlager, Stabilisator, Silentlager, Lenkgetriebe etc.

**Nr. 432 910 MÜLLER Achs- und Radspielprüfer**  
Code: OE78000078



**This easy and helpful tool helps to indicate all kinds of axle space.**

- Diagnostic fault finding
- Visual-, audio- and touch-testing
- Diagnostic e.g. Wheel bearing, suspension joint, suspension strut support, axial joint, stabilizer bar, silent blocks, steering gear etc.

**MUELLER suspension wear indicator**

## UNI-FAHRWERKSATZ SUSPENSION KIT

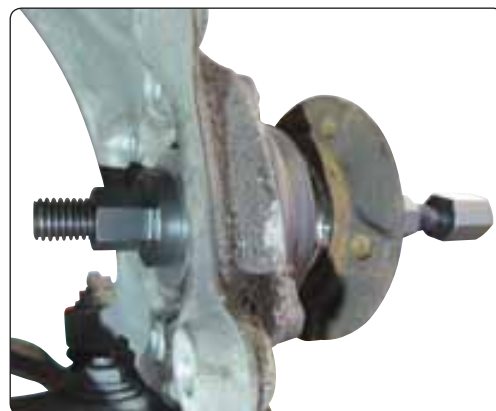
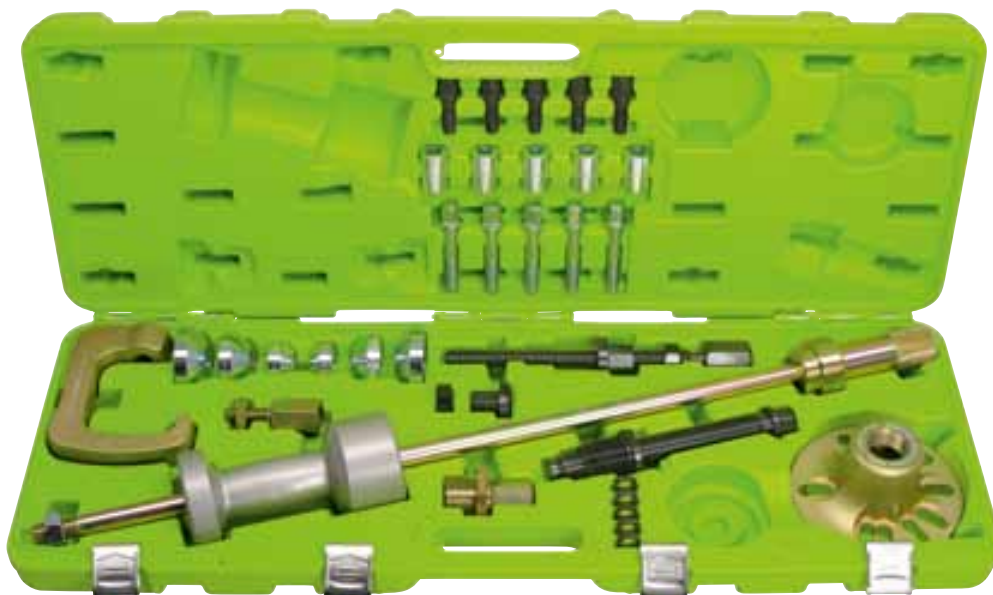

Umfangreiches Werkzeugsortiment für verschiedene Komponenten am Radlagergehäuse. Geeignet z. B. für Radlager, geschraubte Lager-Nabeneinheiten, Radnaben abziehen, Gelenkwellen durchdrücken, Kugelgelenke trennen,

- XL-Schlaggewicht
- Geschmiedeter Abziehflansch
- Geschmiedeter Abziehhaken
- Doppelkonus-Radlagerwerkzeug
- verschiedene Adapter, Scheiben Spezialschrauben

Alle Werkzeuge komplett im stabilen Koffer. Wie bei all unseren Sortimenten und Werkzeugen sind auch hier alle Teile separat erhältlich.

**Nr. 433 100 Uni-Fahrwerksatz**

Code: OE880000880



The master suspension kit can help you to remove all components of the wheel knuckle. From the wheel bearing assembly, to the drive shaft push out and even lower ball joint/suspension arm removal.

The kit includes:

- XL slide hammer
- Drop forged flange
- Drop forged hood
- Twin cone set with a "VIBRO-IMPACT®" spindle
- Adaptor to use your existing tools with the XL slide hammer.

All components are neatly stored in our signature neon green carrying case.

**Suspension kit**



# UNI-ANTRIEBSWELLEN-DURCHDRÜCKER / RADNABEN-ABZIEHER UNI DRIVE-SHAFT PUSHER / HUB PULLER



*original*  
**VIBRO-IMPACT®**



**Universal Werkzeug zum Ausdrücken von geklebten (mikroverkapselten) oder stark verrosteten Antriebswellen.** Eine Beschädigung des Antriebswellengewindes wird verhindert. Passend für nahezu alle 4- und 5-Loch Radnaben mit einem Lochkreis bis 136mm.

VIBRO-IMPACT® Prinzip: Der Vibrations-Schlag des Druckluftschraubers wird über die Trapezgewindespindel auf die Radnabe und Antriebswelle übertragen.

In Verbindung mit dem Schlaggewicht 433 450 kann der gesenkgeschmiedete Flansch auch zum Abziehen von Radnaben eingesetzt werden.

**Nr. 433 414 UNI-Antriebswellen-Durchdrücker / Radnaben-Abzieher Original VIBRO-IMPACT®**  
Code: OE258000258



**Universal tool for pushing out bonded (microencapsulated) or heavily corroded drive shafts.** Damage to the drive shaft thread is prevented. Suitable for almost all 4- and 5-hole wheel hubs with a pitch circle diameter up to 136mm.

The VIBRO-IMPACT® Principle: the vibration impact of the pneumatic wrench is transmitted to the wheel hub and to the drive shaft through the trapezoidal thread spindle.

When used in conjunction with the slide hammer 433 450, the drop-forged flange can also be used for extracting wheel hubs.

**UNI Drive shaft pusher / Hub puller Original VIBRO-IMPACT®**

**Option:**



Nr. 433 450

433 450/14

**Option:**



Nr. 433 435

**RADNABEN-SYSTEMWERKZEUG**  
**WHEEL HUB SYSTEM**



**Basis-Flansch**  
Basic flange

**Nr. 433 433**  
Code: OE208000208



**Grundgerät für Systemanwendung**  
Basic unit for system application



**Nr. 433 435** **Ergänzungssatz**  
Code: OE980000098 Additional kit

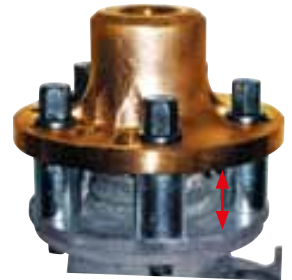

**Ø-Radnabe erweitern**  
to extend the wheel hub-Ø



**Nr. 609 210** **Hydraulik-Spindel 12to.**  
Code: OE164000164 Hydraulic spindle 12to.

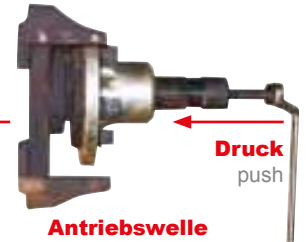

**Antriebswelle durchdrücken**  
pushing the drive shaft



**Nr. 433 450/V2**  
Code: OE198000198  
**Gleithammer**  
Slide hammer

**Nr. 433 450/14**  
Code: OE380000038  
**Adapter für Gleithammer**  
Adapter for slide hammer

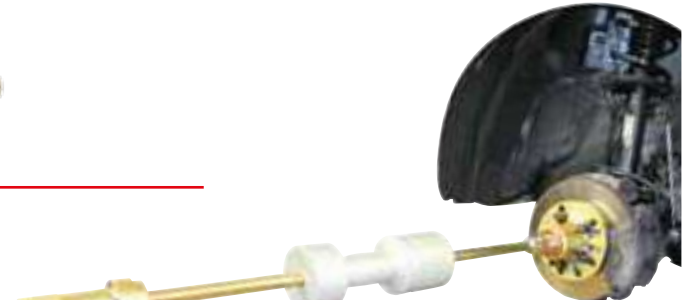

**Radnabe abziehen**  
pulling the wheel hub



**Nr. 433 436** **Achsspiel-Prüfer**  
Code: OE980000098 Axle space detector



**Achsspiel prüfen**  
To check the axle space

Fahrwerk / Suspension  
2  
Brems- & Rad / Brake & Wheel  
3  
Motor / Engine-Tools  
4  
Zerlegung / Cutting Tools  
5  
Karosserie/Verschleiß / AutoBody/Consumables  
6  
Universal-Werkzeuge / Universal Tools  
7  
Transporter & LKW / Heavy Duty & Trucks  
8  
Equipment  
9  
Inhaltsverzeichnis / Table of Contents

# RADNABENABZIEHER PKW, SUV + TRANSPORTER WHEEL HUB PULLER SUV, HEAVY DUTY

Nr. 609 210

**Optional: 12 to. Hydraulik Spindel**

Option: 12 to. Hydraulic spindle



M14

M14x1,5

M12x1,5

**VIBRO-IMPACT® - Spindel TR20 zum durchdrücken der Antriebswelle**  
VIBRO-IMPACT® - spindle TR20 for pulling-out of the axle drive shaft

**Adapter für Stehbolzen: M14 + M16x1,5**  
Adapter for studs M14 + M16x1,5

**Adapter für Gleithammer: M20x1,5 A:UN1 1/2"**  
Adapter for slide hammer: M20x1,5 A:UN1 1/2"

**Ford Transit, MB Sprinter, RENAULT Master, VW LT, OPEL Movano, IVECO Daily, FIAT Ducato, PEUGEOT Boxer etc..**



Nr. 433 450

**Optional: Uni. Gleithammer extra schwer**

Option: Uni. Slide hammer extra heavy



**Zur Demontage z. B. Bremstrommeln, Bremsscheiben, Radnabe, Radlager, Lagereinheit, Gelenkwellen.** Universell verwendbar mit Schlaggewicht oder Hydraulikspindel. Passend für:

**Radstehbolzen:**

5 + 6er Teilung M14 + M16x1,5 durch Aufschraubhülsen.

**Radschrauben:**

5 + 6er Teilung M12x1,5, M14 + M14x1,5

**Nr. 433 444 Radnabenabzieher Transporter**

Code: OE648000648



**For de-mounting brake-drums, brake-discs, wheel-hubs, wheel bearing, bearing-hub-unit, drive-shafts.** Universal use with slide hammer or hydraulic spindle. Fits for **Wheel studs:**

5 + 6 holes wheels M14 + M16x1,5.

**Wheel bolts:**

5 + 6 holes wheels M12x1,5, M14 + M14x1,5

**Wheel hub puller heavy duty**

**SYSTEMANWENDUNGEN UNIVERSAL GLEITHAMMER**  
**SYSTEM APPLICATIONS UNIVERSAL SLIDE HAMMER**



**537 710**  
**Antriebswellen-Trenner M16x1,5**  
Drive shaft separator M16x1.5

**433 450/25**  
**Adapter für Doppelhaken**  
Adapter for double hook



**433 450/28**  
**Universal Doppelhaken für Karosserie**  
Universal double hook for bodywork



**433 450/4**  
**VW T4 Radnabe hinten mit vorhandenem Flansch + Adapter**  
VW T4 wheel hub with existing flange and adapter



**433 433 + 433 450/14**  
**MÜLLER Universal Flansch + Adapter zur Radnabenmontage**  
MUELLER Universal flange and adapter for wheel hub mounting

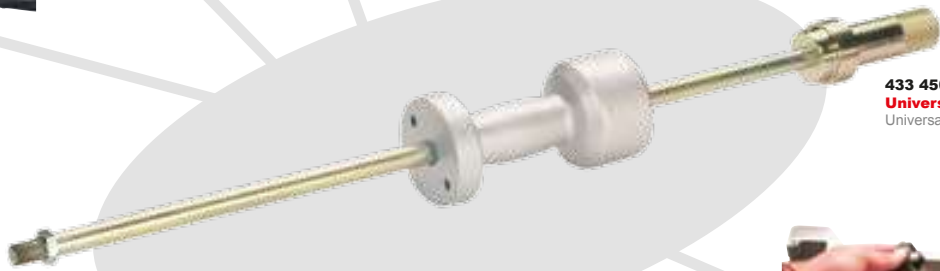

**433 450/V2**  
**Universal Gleithammer**  
Universal Slide Hammer



**600 122**  
**Injektorenzug DB CDI Motoren**  
Injector puller DB CDI motors



**gesenkgeschmiedet**  
drop forged



**433 450/27**  
**Ford Mondeo Demontage Querlenker (auch DB Vito)**  
De-mounting Ford Mondeo lower suspension arm (also DB Vito)

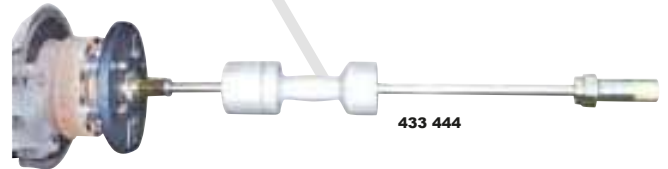

**433 444**

**Adapter mit Innengewinde M20x1,5 für MÜLLER Gleithammer**  
Adapter with inner thread M20x1.5 for MUELLER slide hammer

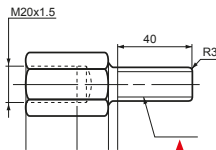

- Nr. 433 450/4** Code: OE380000038  
Außengewinde / outside thread M16x2,0
- Nr. 433 450/6** Code: OE380000038  
Außengewinde / outside thread M18x2,5
- Nr. 433 450/8** Code: OE380000038  
Außengewinde / outside thread M18x1,5
- Nr. 433 450/10** Code: OE380000038  
Außengewinde / outside thread M20x2,5
- Nr. 433 450/11** Code: OE380000038  
Außengewinde / outside thread M20x2,0
- Nr. 433 450/14** Code: OE380000038  
Außengewinde / outside thread UN1 1/2"
- Nr. 433 450/16** Code: OE380000038  
Außengewinde / outside thread M42x2 z. B. KL

**Adapter für bereits vorhandene Schlaggewichte mit anderen Gewinden**  
Adapter for existing slide hammers with other threads

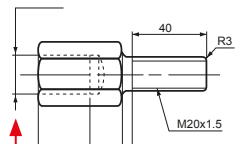

- Nr. 433 450/25** Code: OE380000038  
Adapter z. B. für Doppelhaken / Adapter e. g. for double hook
- Nr. 433 450/27** Code: OE980000098  
Ausziehbügel M20x1,5  
Kugelgelenke / Karosserie  
Massive, gesenkgeschmiedete Ausführung, auch z.B für Karosseriearbeiten geeignet.  
Universal hook M20x1.5 for balljoints, bodywork  
Durable, drop-forged tool. Can be used as well for car-body works.
- Nr. 433 450/28** Code: OE380000038  
Doppelhaken / double hook

- Nr. 433 450/45** Code: OE380000038  
Innengewinde / inner thread UNC 5/8"
- Nr. 433 450/46** Code: OE380000038  
Innengewinde / inner thread M16x2,0
- Nr. 433 450/48** Code: OE380000038  
Innengewinde / inner thread M18x2,5
- Nr. 433 450/49** Code: OE380000038  
Innengewinde / inner thread M18x1,5
- Nr. 433 450/50** Code: OE380000038  
Innengewinde / inner thread M20x2,5
- Nr. 433 450/51** Code: OE380000038  
Innengewinde / inner thread M20x2,0

2 Fahrwerk / Suspension  
 3 Bremse & Rad / Brake & Wheel  
 4 Motor / Engine-Tools  
 5 Zerspanung / Cutting Tools  
 6 Karosserie/Verschleiß / AutoBody/Consumables  
 7 Universal-Werkzeuge / Universal Tools  
 8 Transporter & LKW / Heavy Duty & Trucks  
 9 Equipment  
 Inhaltsverzeichnis / Table of Contents

## RADNABENABZIEHER INKL. GLEITHAMMER WHEEL HUB BASIC UNIT INCL. SLIDE HAMMER



Nr. 433 437

Nr. 433 433

Code: OE2088000208

**Radnabenabzieher**  
Wheel hub basic unit



**Universal Radnaben-Abziehsystem.** Passend für fast alle 4- und 5-Loch Naben. Ideal für z.B. VW, Audi, Seat, Skoda, Opel, Volvo, Fiat, Renault, Peugeot, Citroen etc.

Nr. 433 437 **Radnabenabzieher**  
inkl. Gleithammer + Adapter

Code: OE398000398



Nr. 433 450/14

Code: OE380000038

**Adapter UN 1 1/2"**  
Adapter UN 1 1/2"



Nr. 433 450

Code: OE228000228

**Gleithammer 6+3Kg**  
Slide hammer 6+3Kg



**Universal wheel hub system kit.** Suitable for almost all 4 and 5-hole hubs. Ideal for e.g. VW, Audi, Seat, Skoda, Opel, Volvo, Fiat, Renault, Peugeot, Citroen etc.

**Wheel hub basic unit**  
incl. Slide hammer

## SPURSTANGENZANGE UNIVERSAL TIE ROD WRENCH



Selbstspannend, 2 Griffängen für besseren Zugang. Extra breite Maulöffnung. Universell passend für 6-kant und rund. Maulbreite: 40mm, Greiföffnung 14-23mm, Griffänge 260mm + 390mm

Nr. 512 002 **Spurstangenzange Universal**

Code: OE128000128



**Inner tie rod multi grip plier!**

Alignment problems by rusty and stocked inner tie rod adjustments? This plier has the grip you need on any round or hex surface of the rod. Two lengths of levers for maximum power or narrow spaces.

Grip width: 40 mm, Grip diameter: 14 - 23 mm, Lever length: 260 - 390 mm

**Tie Rod Wrench**

## SHOCK KUGELGELENK-AUSDREHER TIE ROD END SOCKET



Zum Ausdrehen der ausgeschlagenen Kugelgelenke aus den Spurstangen. Zeitaufwendiges drehen per Hand, wird durch dieses für Schlagschrauber geeignete Werkzeug überflüssig.

**Nr. 512 050 Shock-Kugelgelenk-Audreher**

Code: OE348003480



Usefull to replace the worn out tie rod ends. There is no time intensive turning by hand necessary with this impact tool.

**Nr. 512 050 Tie rod end socket**

Code: OE348003480



**Schlagschrauber-geeignet**  
Impact wrench - proofed



## MERCEDES SPUR-EINSTELLSCHLÜSSEL ALIGNMENT-WRENCH



**XZN M12 /  
Spline**



Zur Einstellung der Hinterachsspur ohne Demontage der Unterbodenverkleidung. Kein Abreißen der Kunststoffschrauben an den Unterbodenverkleidungen. Universell passend für fast alle Mercedes Fahrzeuge C, E, S, ML-Klasse etc.



- Universal fit for most Mercedes
- Adjust rear axle toe without removing plastic underbody cover
- Avoids damaging plastic fasteners
- Money and time saver

**Nr. 512 712 Uni-Spurschlüssel  
Daimler**

Code: OE480000048

**Wheel alignment  
wrench Mercedes**



## STURZ-EINSTELLWERKZEUG WHEEL CAMBER ADJUSTER



Zum exakten und gefühlvollen Einstellen des Radsturzes. Passend z. B. für Golf II, Golf III, Passat...

**Nr. 514 300 Sturz-Einstellwerkzeug**

Code: OE680000068

**Nr. 514 300/2 Sturz-Einstellwerkzeug,  
2-tlg. Satz**

Code: OE130000130



For exact and sensitive adjustment of the wheel camber. Fits many cars. Perfect for Golf II, Golf III, Passat...

**Wheel camber adjuster**

**Wheel camber adjuster 2pcs.**

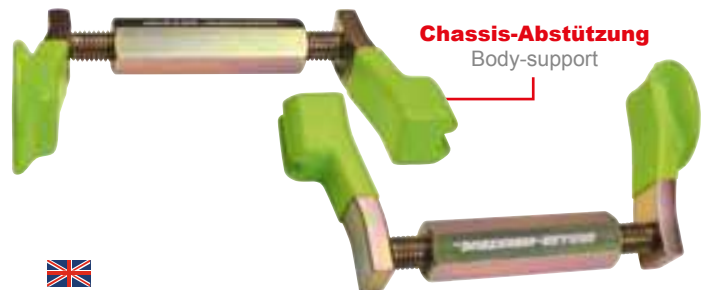

**Chassis-Abstützung**  
Body-support

## ANTRIEBSWELLEN-MONTAGEHILFE M16x1,5 DRIVE SHAFT MOUNTING KIT M16x1,5

**z. B. VW, Audi, Seat, Skoda...**

e. g. VW, Audi, Seat, Skoda...



- Nützliches Spezialwerkzeug zur Demontage und Montage von Antriebswellen M16x1,5.
- z. B. VW, Audi, Seat, Skoda etc.
- Deutliche Arbeitserleichterung, da nur ein Mann benötigt wird.

**Nr. 537 700 Antriebswellen-Montagehilfe M16x1,5**  
Code: OE148000148



- Helpful special tool for demounting and mounting of the drive shafts M16x1,5.
- e. g. VW, Audi, Seat, Skoda etc.
- This job can be done now by 1 person.

**Nr. 537 700 Drive shaft mounting kit M16x1,5**  
Code: OE148000148

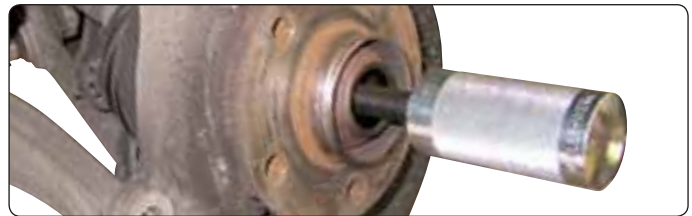

## ANTRIEBSWELLEN-TRENNER M16x1,5 DRIVE SHAFT SEPARATOR M16x1,5



- Nützliches Spezialwerkzeug zum Trennen der Gleichlaufgelenke an Antriebswellen M16x1,5
- Schnell und effektiv durch Verwendung des Schlaghammers
- Passend für Innen- und Außengewinde M16x1,5

**Nr. 537 710 Antriebswellen-Trenner M16x1,5**  
Code: OE980000098



- Helpful special tool for separation of the drive shaft joint (constant velocity joint)
- Quickly and effectively because of slide hammer use.
- Fits for internal and external metric threads M16x1.5

**Nr. 537 710 Drive shaft separator M16x1,5**  
Code: OE980000098



**z. B. VW, Audi, Seat, Skoda...**  
e. g. VW, Audi, Seat, Skoda...



## AUSBOHRSATZ 4-LENKER-ACHSEN DRILLING-OUT SET 4-LINK-SUSPENSION



**Zum exakt mittigen Anbohren der 4-Lenker Klemmschraube.** Druckbolzen drückt optimal im Schraubenkern innerhalb des Gusskörpers. Gewindeende der Schraube kann somit nicht mehr gestaucht (aufgeweitet) werden. Auch für den neuen Alu-Schraubentyp geeignet.

### Nr. 603 334 Ausbohrersatz 4-Lenker-Achsen

Code: OE985009850



**For the exact central drilling of the 4-link locking screw.** The pressure pin pushes optimally in the screw core inside the cast body. The end of the screw thread can therefore no longer be flattened (widened). Also for the new alu type of locking screw.

### Nr. 603 334 Drilling out set 4-Link Suspension

Code: OE985009850

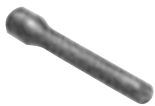

**9,38x63mm  
Stift**  
pin



**30x45x4,5mm  
Bohrbuchse**  
Drill sleeve



**30x45x7,3mm  
Bohrbuchse**  
Drill sleeve

**Spezialbohrer / Special drill**



**7,3mm HSSE TIN**



**4,5mm HSSE TIN**

## AUSBOHRSATZ ALU-4-LENKER-ACHSEN PINCH BOLT REMOVAL KIT



**Nr. 603 336-1  
Bohrbuchse**  
Drill-sleeve  
Code: OE25000025



**Nr. 603 336-5 HSSE-TICN  
Spezialaufbohrer**  
Special drill  
Code: OE800000008



**Nr. 603 336-4 HSSE-TIN  
Spezial-Bohrer, 7,3mm**  
Special drill, 7,3mm  
Code: OE891008910



**Nr. 603 334-3  
Stift, 9,8x63mm**  
Pin, 9,8x63mm  
Code: OE960000960



**Nr. 290 214  
Durchschlag 6,5mm für  
Drucklufthammer**  
Pin punch 6,5mm for air hammer  
Code: OE430000043



**Zum exakt mittigen Anbohren der Alu-4-Lenker Klemmschraube.** Abbohren des Schrauben-6-kant-Kopfes. Druckbolzen drückt optimal im Schraubenkern innerhalb des Gusskörpers. Gewindeende der Schraube kann somit nicht mehr gestaucht (aufgeweitet) werden.

### Nr. 603 336 Ausbohrersatz Alu-4-Lenker-Achsen

Code: OE148000148



**For the removal of the aluminum 4-link locking bolt via the exact central drilling method.** Removes rusted and corroded bolts easily with this 3-step kit. By pushing the bolt out with the pressure pin the end of the screw thread can not be widened. Use with the Nr. 290 206 high performance air hammer for best results.

### Pinch Bolt Removal Kit



## EXZENTER KLEMM- / DREHVORRICHTUNG EXCENTRIC TURN CHUCK



**Komplett gesenkgeschmiedet**  
Completely Drop-Forged



**Maximaler Halt**  
Maximum Grip



**Spezialwerkzeug zum Verdrehen / Gegenhalten der Spurstangen** oder Spurstangen-Kugelgelenke. Einseitig zu öffnen, dadurch absolut universelle Anwendung möglich. Verwendung bei Spureinstellung, Austausch der Kugelgelenke.

**Nr. 608 950 Exzenter Klemm-/Drehvorrichtung**  
Code: OE112000112



**Special tool for turning/fixing the tie rod** or ball joints. Use for ball joint replacement or wheel alignment.

**Nr. 608 950 Excentric turn chuck**  
Code: OE112000112

## SPURSTANGEN-ZANGENSATZ TIE ROD PLIER KIT



**Selbstspannend**, universell passend. 2tlg. 240 / 350mm  
**Nr. CHA-410/414 Spurstangen-Zangensatz, 2-tlg.**  
Code: OE11301011301



**Plier kit 2pcs self clamping**, fits universally. 240 / 350 mm  
**Tie rod plier kit, 2pcs.**

## KUGELGELENKABZIEHER BALL JOINT SEPARATOR



**Zum sicheren Ausdrücken der Führungsgelenke** aus Achsschenkel, Spurstangenhebel, Querlenker und Federbein. Der Abzieher eignet sich besonders für Fahrzeuge der Typen Opel (Vectra, Calibra und Astra), Ford (alle PKW und Transit), VAG, BMW, DB, Citroën (außer CX), Renault, Fiat, NFZ, Honda (Traggelenk), alle Japaner.

### Nr. 609 001 Kugelgelenkabzieher

Code: OE690000069



**To separate the ball joints.** Save and professional. Drop forged quality. All parts also available separately. Universal use. Example Opel, Audi, Ford, VAG, BMW, DB...

### Nr. 609 001 Ball joint separator

Code: OE690000069

**Max. Höhe: 47mm**

Max. amount: 47mm



**Ø max. 19,50mm**

**Zweifach-Verstellbar**  
Double adjustable

**Kugelgelagerte Spindel**  
Suspension spindle

## KUGELGELENKABZIEHER 4-FACH VERSTELLBAR BALL JOINT SEPARATOR 4-WAY



**24, 30, 40 + 45mm**  
**4-fach - Höhenverstellung**  
4-positions adjustable



**Ø 20mm**



### Mercedes Typ W211

**Anwendungsbeispiel /** Example of use



**Speziell für italienische Fahrzeuge.** Hochwertiger und massiver Abzieher für Kugelgelenke am PKW. Universell passend. Druckhebel 4-fach verstellbar. Sehr schlanke, aber dennoch robuste Ausführung. Kunststoffbeschichtet. Ideal für Fiat, Alfa, Lancia, etc.

### Nr. 609 101/4 Kugelgelenkabzieher 4-fach verstellbar

Code: OE680000068



**To separate the ball joint.** Save and professional. Drop forged quality. All parts also available separately. Universal use. Perfect for italian cars as Alfa, Fiat, Lancia.

### Ball joint separator 4-way

## VIBRO-IMPACT® ABZIEHGLOCKEN VIBRO-IMPACT® BELL SHAPE SEPARTOR



**Gehärtet + vergütet**  
Hardened + coated

**Schlagschrauberfeste  
Trapezgewindespindel**  
Square thread spindle impact proofed

**Druckstück kugelgelagert**  
Ball beared press spindle

**Nr. 609 039**  
**z.B. für DB 1424**  
e.g. DB 1424

**Nr. 609 039**  
**z.B. für DB Actros 2**  
e.g. DB Actros 2

**Nr. 609 035**  
**z.B. für DB Sprinter / VW LT**  
e.g. DB Sprinter / VW LT



**Dreh-Schlagimpuls** durch Verwendung von Schlag-schrauber. Dieser Dreh-Schlagimpuls hat die selbe Wirkung wie z. B. ein kräftiger Hammerschlag. Insbesondere bei Kegelsitzverbindung ist diese Abziehmethode weitaus effektiver als bisherige Hebelabzieher. 35mm Abziehglocke speziell für VW LT und DB Sprinter.

**Nr. 609 030 Abziehglocke 30mm**

Code: OE158000158

**Nr. 609 032 Abziehglocke 32mm**

Code: OE198000198

**Nr. 609 035 Abziehglocke 35mm**

Code: OE298000298

**Nr. 609 039 Abziehglocke 39mm**

Code: OE268000268



**VIBRO-IMPACT® principle through power gun drive.** This VIBRO-IMPACT® has the same result as striking the joint with a hammer. Especially cone seat connections can be separated much quicker than traditional pullers.

**Bell shape 30mm**

**Bell shape 32mm**

**Bell shape 35mm**

**Bell shape 39mm**

**VIBRO-IMPACT® ABZIEHSYSTEM FÜR KUGELGELENKE**  
**VIBRO-IMPACT® BALL JOINT SEPARATING KIT**



Nr. 609 033/5



**Alle Gabeln einzeln erhältlich:**

All Forks separately available:

Size	Nr.	Code
<b>24mm</b>	<b>609 033-24</b>	OE78000078
<b>27mm</b>	<b>609 033-27</b>	OE78000078
<b>31mm</b>	<b>609 033-31</b>	OE78000078

**optional erhältlich / optional:**

<b>36mm</b>	<b>609 033-36</b>	OE78000078
-------------	-------------------	------------



- The Ball Joint Separator has a very rugged and flat design, with 3 interchangeable forks. These are attached to the center screw to allow continuous adjustment within the jaw capacity range.
- Completely drop forged.
- Jaw capacity range from 30 – 65 mm
- 3 different fork sizes (24, 27 and 31 mm) make a very adaptable separator.
- Safe to use.
- e.g. Audi / VW (A3, A4 and A6 with double wishbone), BMW, Mercedes-Benz.
- Comes with **VIBRO-IMPACT®** reaction screw. Making your work quick and safe.
- No damage to aluminum parts and rubber components.

**VIBRO-IMPACT® Ball joint separating kit**

3 Fork sizes 24, 27, 31mm, basic device

**VIBRO-IMPACT® Ball joint separating kit**

3 Fork sizes 24, 27, 31mm, basic device,  
Wall Mount

Wall Mount



- gesenkgeschmiedet
- mit **VIBRO-IMPACT®** Spindel
- perfekt für Alu-Fahrwerke
- 3 verschiedene Gabeln: **24, 27 und 31 mm**
- Höhenverstellung **30 - 65 mm**

**Nr. 609 033 VIBRO-IMPACT® Abziehsystem,**  
Code: OE198000198  
3 Gabeln 24, 27, 31mm, Grundgerät

**Nr. 609 033/5 VIBRO-IMPACT® Abziehsystem,**  
Code: OE218000218  
3 Gabeln 24, 27, 31mm, Grundgerät,  
Wandhalterung

Nr. 609 033-WH Wandhalterung  
Code: OE380000038

## DRUCKSTÜCKSÄTZE FÜR KUGELBOLZEN PRESSURE PIECE KIT FOR BALL JOINT



Nr. 609 137



**Druckstücksätze für Universal-Pressrahmen** zur Demontage von Traggelenken (Kugelbolzen).

**Nr. 609 114**

Code: OE128000128

**DB W124, 129, 201**

Aus- und Einbau Traggelenk außen, Anwendung direkt am Fahrzeug.

**Nr. 609 137**

Code: OE154000154

**BMW (3er), E36**

Aus- und Einbau Traggelenk unten, kein Ausbau des Querlenkers nötig.

**Nr. 609 144**

Code: OE178000178

**VW T4 ab Bj. '92**

Aus- und Einbau Traggelenk oberer Querlenker, Anwendung direkt am Fahrzeug.

**Nr. 609 145**

Code: OE178000178

**Renault Laguna,**

Aus- und Einbau Traggelenk Vorderachse, Anwendung direkt am Fahrzeug

**Nr. 609 147/V2**

Code: OE238000238

**VW LT + DB Sprinter** bis Bj. '06 / ab Bj. '06

Aus- und Einbau Traggelenk Ø 45mm, Anwendung direkt am Fahrzeug

**Nr. 609 148**

Code: OE198000198

**BMW (3er) E30**

Aus- und Einbau Traggelenk unten, Anwendung direkt am Fahrzeug

**Nr. 609 149**

Code: OE219000219

**Renault Master/Opel Movano**

Aus- und Einbau Traggelenk Vorderachse oben, Anwendung direkt am Fahrzeug.

**Nr. 609 150**

Code: OE219000219

**Renault Master/Opel Movano**

Aus- und Einbau Traggelenk Vorderachse unten, Anwendung direkt am Fahrzeug.



**Pressure piece kits for universal press frame** to dismantling the suspension joints (ball joint).

**DB W124, 129, 201**

direct on-vehicle dismantling/installation, suspension joint outside the wishbone

**BMW (3er) E36**

direct on-vehicle dismantling/installation, bottom suspension

**VW T4 from '92**

direct on-vehicle dismantling/installation, suspension joint top wishbone

**Renault Laguna**

direct on-vehicle dismantling/installation, suspension joint front axle

**VW LT + DB Sprinter**

direct on-vehicle dismantling/installation, Ø45mm suspension joint

**BMW (3er) E30**

direct on-vehicle dismantling/installation, bottom suspension joint

**Renault Master/Opel Movano**

direct on-vehicle dismantling/installation, top suspension joint

**Renault Master/Opel Movano**

direct on-vehicle dismantling/installation, bottom suspension joint

## UNIVERSAL PRESSRAHMEN UNIVERSAL BASE FRAME



**Nr. 609 115**

Code: OE218000218

**Universal Pressrahmen**

Universal base frame



**Nr. 609 120**

Code: OE298000298

**Universal Pressrahmen inkl. Adapter-Satz passend für 609 400**

Universal base frame incl. adapter-kit fits for 609 400



**Nr. 609 310**

Code: OE769000769

**Universal Pressrahmen inkl. Hydraulik Zylinder 10 ton.**

Universal base frame incl. 10 ton. hydraulic cylinder



**Nr. 609 311**

Code: OE848000848

**Uni. Pressrahmen inkl. 10 ton. Hydraulik-Einheit**

Uni. base frame incl. 10 ton. hydraulic unit



**Nr. 609 312**

Code: OE374000374

**Uni. Pressrahmen inkl. 12 ton. Hydraulikspindel**

Uni. base frame incl. 12 ton. hydraulic spindle



**Nr. 609 315**

Code: OE368000368

**Uni. Pressrahmen inkl. mechanischer Spindel TR27**

Uni. base frame incl. spindle TR27



**Universell, am Fahrzeug einsetzbares Grundgerät** zum Aus- und Einbau z. B. von Traggelenken (Kugelbolzen), Silentlagern (Metall- / Gummilager) z. B. BMW, DB, Audi, Renault, VW, Mazda etc. Auswechselbare 6-kant Stangen in verschiedenen Ausführungen und Längen lieferbar.



**Universal use directly on the car.** For removing and installing of ball joints, rubber bushings for example at BMW, DB, Audi, Renault, VW, Mazda, etc. Interchangeable hex rods in different lengths available.

**VIBRO-IMPACT® Spindel  
Schlagschrauber  
geeignet**

Square thread spindle  
impact proofed



**VIBRO-IMPACT® XL PRESSRAHMEN  
XL PRESS FRAME**

**Adapter passend  
für Druck- und  
Zughülzensatz  
Nr. 609 400**  
Fits for Press and  
Pull Sleeve kit

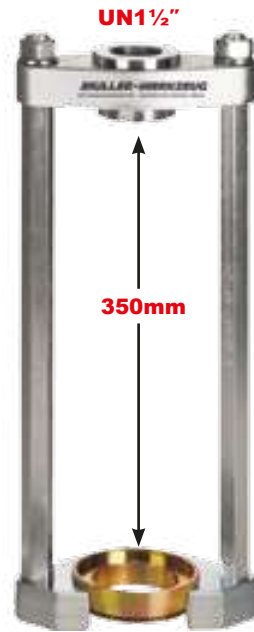

UN1½"

350mm



**Universell, am Fahrzeug  
einsetzbares Grundgerät**  
zum Aus- und Einbau z. B.  
von Tragelenken (Kugelbol-  
zen), Silentlagern (Metall- /  
Gummilager) z. B. BMW, DB,  
Audi, Renault, VW, Mazda  
etc.



**Universal use directly on  
the car.** For removing and  
installing of ball joints, rub-  
ber bushings for example at  
BMW, DB, Audi, Renault, VW,  
Mazda, etc.

**Nr. 609 315**  
Code: OE368000368

**XL Press-Rahmen mit VIBRO-IMPACT® Spindel**  
XL Press-Frame incl. VIBRO-IMPACT® Spindle

**Nr. 609 316**  
Code: OE378000378

**XL Press-Rahmen ohne Spindel**  
XL Press Frame without Spindle

**KOMBINATIONSWERKZEUGE FÜR PRESSRAHMEN  
COMBINATION TOOLS FOR BASE FRAME**



**Nr. 609 115/DZ**  
Code: OE94000094

**Ergänzungssatz für Nr. 609 115  
zur Verwendung mit Druck- und  
Zughülzensätzen**

Kit for no. 609 115 for usage with  
press and pull sleeve kits



Hub: 15mm

**Nr. 609 210**  
Code: OE164000164

**12 to. Hydraulikspindel**  
12 to. hydraulic spindle



**Kombinations-Werkzeuge**  
für Universal Pressrahmen.



**Combination-tool**  
for universal base frame.



**Nr. 609 214**  
Code: OE148000148

**Spindel mechanisch, TR27 inkl. Adapter**  
Mechanic spindle, TR27 incl. adapter



Hub: 100mm

**Nr. 609 215**  
Code: OE553000553

**10 to. Hydraulik-Einheit**  
10 to. hydraulic unit

Hub: 200mm



**Nr. 609 206**  
Code: OE648000648

**10 to. Hydraulik Zylinder**  
10 to. hydraulic cylinder

## FORD TRANSIT KUGELGELENK-PRESSWERKZEUG FORD TRANSIT BALL JOINT TOOL



**Schneller und problemloser Aus- und Einbau** der unteren Traggelenke direkt am Fahrzeug. Passend für Ford Transit Bj. 2000 - 2013. Zeitersparnis, da der Ausbau des Achsschenkels entfällt.

Option: Anwendung mit 12 to. Hydraulik-Spindel (Nr. 609 210) + Aufnahmeadapter (Nr. 609 103/A)

**Nr. 609 131 FORD Transit Kugelgelenk-Presswerkzeug**  
Code: OE36800368



**For the removal and installation** of the lower front ball joints as found on FORD Transit from 2000 - 2013.

On vehicle solution provides time saving benefits. Tool designed to access the awkward location of the ball joint.

Hydraulic option includes 12 to hydraulic spindle (no. 609 210) + adapter (no. 609 103/A)

**FORD Transit Ball Joint Tool**

## FORD TRANSIT DRUCKSTÜCKSATZ FORD TRANSIT ARM BUSH TOOL



**Demontage- und Montagewerkzeug des großen hinteren Silentlagers** am vorderen Längsträger, Ford Transit Bj. 2000 - 2013. Anwendung an der Werkstattpresse oder direkt am Fahrzeug mit Müller-Universal Pressrahmen (Nr. 609 115).

**Nr. 609 138 FORD Transit Druckstücksatz**  
Code: OE18800188



**For the removal and replacement of the large rear bush** on the front lower arms of FORD Transit from 2000 - 2013. Designed to be used with a 609 115 Universal Press Frame (no. 609 312 incl. 12 to. Hydraulic spindle). On vehicle solution with minimal strip down. Can also be used in a workshop press for lower arms when they have been removed from the vehicle.

**FORD Transit Arm Bush Tool**



## DRUCKSTÜCKSÄTZE FÜR SILENTLAGER PRESSURE PIECE KIT FOR SILENT BEARINGS



Nr. 609 175



**Druckstücksätze für Universal-Pressrahmen** zur Demontage von Trag Gelenken (Kugelbolzen).

- Nr. 609 146** **VW Golf 3**, Aus- und Einbau Silentlager Hinterachse, Anwendung direkt am Fahrzeug  
Code: OE224000224
- Nr. 609 164** **VW Golf 1/2/3, Vento, Passat Bj. 88-96**, Aus- und Einbau Silentlager, vorne, Anwendung direkt am Fahrzeug  
Code: OE198000198
- Nr. 609 165** **VW Golf 3 Variant, Passat Bj. 88-96**, Aus- und Einbau Silentlager, Hinterachse, Anwendung direkt am Fahrzeug  
Code: OE370537050
- Nr. 609 168** **VW Golf 4, Audi A2/A3** Aus- und Einbau Silentlager, Hydro- und Kunststofflager, Anwendung direkt am Fahrzeug  
Code: OE298000298
- Nr. 609 171** **DB W202, C-Klasse** Aus- und Einbau Silentlager, Querlenker vorne, Anwendung direkt am Fahrzeug  
Code: OE328000328
- Nr. 609 172** **DB W210, E-Klasse** Aus- und Einbau Silentlager, Querlenker vorne, Anwendung direkt am Fahrzeug  
Code: OE418000418
- Nr. 609 175** **Renault Laguna** Aus- und Einbau Silentlager, Hinterachse, Anwendung direkt am Fahrzeug  
Code: OE189000189
- Nr. 609 180** **BMW E36/E46** Aus- und Einbau Silentlager, Hinterachs-Längsträger, Anwendung direkt am Fahrzeug  
Code: OE198000198



**Pressure piece kits for universal press frame** to dismantling the suspension joints (ball joint).

- VW Golf 3**, direct on-vehicle dismantling/ installation, silent bearing, rear axle
- VW Golf 1/2/3, Vento, Passat Bj. 88-96**, direct on-vehicle dismantling/installation, front silent bearing
- VW Golf 3 Variant, Passat Bj. 88-96**, direct on-vehicle dismantling/installation, rear silent bearing
- VW Golf 4, Audi A2/A3** direct on-vehicle dismantling/installation, front silent/plastic bearing
- DB W202, C-Klasse** direct on-vehicle dismantling/installation, front silent bearing
- DB W210, E-Klasse** direct on-vehicle dismantling/installation, front silent bearing
- Renault Laguna** direct on-vehicle dismantling/installation, rear axle bushing
- BMW E36/E46** direct on-vehicle dismantling/installation, rear silent bushing suspension

## KOMBI-SET FÜR VW LT / DB SPRINTER COMBI-SET FOR VW LT / DB SPRINTER



**Kombi-Set Nr. 609 147 / 312 / 035, bestehend aus:  
Abziehglocke 35mm, Universal-Pressrahmen  
inkl. 12 to. Spindel + Druckstücke**

Combi-Set no. 609 147 / 312 / 035, composed of:  
Bell shape separator 35mm, Uni. base frame  
incl. 12 to. spindle + pressure piece kit



**Kombinations-Werkzeug** zum Aus- und Einbau der Trag-  
gelenke (Kugelbolzen) am vorderen Querlenker. Zur Demon-  
tage und Montage direkt am Fahrzeug bei VW LT / DB Sprinter.  
Mit 12 to. Hydraulikspindel.

**Nr. 609 147 / 312 / 035 Kombi Set 12 to.  
Hydraulikspindel**  
Code: OE698000698



**Combination tool** for the direct on vehicle dismantling and  
installation of the suspension joints at VW LT / DB Sprinter.  
With 12 to. hydraulik spindle.

**Nr. 609 147 / 312 / 035 Combi kit with 12 to.  
Hydraulic spindle**  
Code: OE698000698

**Alle Teile einzeln erhältlich:**  
All parts separately available:



**Nr. 609 035**  
Code: OE298000298

**35mm  
Abziehglocke**  
Bell shape  
separator



**Nr. 609 147/V2**  
Code: OE238000238

**LT/Sprinter  
Druckstücksatz**  
Pressure piece kit



**Nr. 609 312**  
Code: OE374000374

**Uni. Pressrahmen  
inkl. 12 to. Hydraulik  
Spindel**  
Uni. Base frame incl.  
12 to. hydraulic spindle

## DRUCKSTÜCKSATZ VW POLO 9N ADAPTER KIT VW POLO 9N



**Spezialwerkzeug zum Aus- und Einziehen der  
Kunststofflager** in der Aggregate-Trägereinheit bei  
folgenden Fahrzeugen: VW Polo 9N, Audi A2, Skoda  
Fabia, Seat Cordoba, Seat Altea...

**Nr. 609 166 Druckstücksatz VW Polo 9N**  
Code: OE248000248



**Individual suspension bush removal and in-  
stalling tool.** Especially made for the rear bush on the  
front control arm. Fits for VW Polo 9N, Audi A2, Skoda  
Fabia, Seat Cordoba, Seat Altea...

**Nr. 609 166 Adapter kit VW Polo 9N**  
Code: OE248000248





**Einfache und sichere Montage des Kunststofflagers in  
der Aggregate-Trägereinheit VW Polo 9N.**

Safe suspension bush removal and installing tool of the aggregate unit  
VW Polo 9N

OPTION HYDRAULIK  
ab Seite 2-60

OPTION HYDRAULIC  
on page 2-60

## EINZELTEILE FÜR DRUCK- UND ZUGHÜSENSATZ SPARE PARTS FOR PRESS AND PULL SLEEVE KIT

Art.-Nr. no.	Durchmesser Außen outside diameter	Durchmesser Innen inner diameter			609 390 XS Druck- und Zughülsen-Satz 609 390 XS press and pull sleeve kit	609 390/Basic XS Druck- und Zughülsen-Satz (Kombisatz zu 609 400) 609 390/Basic XS press and pull sleeve kit (Kombi kit for no. 609 400)	609 390/10 XS Druck- und Zughülsen 10-tlg. 609 390/10 XS press and pull sleeve kit 10 pcs.
							
609 390-14/24	24,00 mm	14,00 mm	XS-Stufen-Druckhülse 14/24	XS-Sleeve 14/24	x	x	x
609 390-16/26	26,00 mm	16,00 mm	XS-Stufen-Druckhülse 16/26	XS-Sleeve 16/26	x	x	x
609 390-18/28	28,00 mm	18,00 mm	XS-Stufen-Druckhülse 18/28	XS-Sleeve 18/28	x	x	x
609 390-20/30	30,00 mm	20,00 mm	XS-Stufen-Druckhülse 20/30	XS-Sleeve 20/30	x	x	x
609 390-22/32	32,00 mm	22,00 mm	XS-Stufen-Druckhülse 22/32	XS-Sleeve 22/32	x	x	x
609 390-24/34	34,00 mm	24,00 mm	XS-Stufen-Druckhülse 24/34	XS-Sleeve 24/34	x	x	x
609 390-26/36	36,00 mm	26,00 mm	XS-Stufen-Druckhülse 26/36	XS-Sleeve 26/36	x	x	x
609 390-28/38	38,00 mm	28,00 mm	XS-Stufen-Druckhülse 28/38	XS-Sleeve 28/38	x	x	x
609 390-30/40	40,00 mm	30,00 mm	XS-Stufen-Druckhülse 30/40	XS-Sleeve 30/40	x	x	x
609 390-32/42	42,00 mm	32,00 mm	XS-Stufen-Druckhülse 32/42	XS-Sleeve 32/42	x	x	x
609 400/P1			Stufenplatte Nr. 1	Step Disc No. 1	x		
609 400/P2			Stufenplatte Nr. 2	Step Disc No. 2	x		
609 400/P3			Stufenplatte Nr. 3	Step Disc No. 3	x		
609 400/P4			Stufenplatte Nr. 4	Step Disc No. 4	x		
609 400/S10			Spindel M10 ohne Mutter	Spindle M10 without Nut	x		
609 400/S12			Spindel M12 ohne Mutter	Spindle M12 without Nut	x		
609 400/D10			Druckmutter M10 mit Lager	Nut M10 with Bearing	2x		
609 400/D12			Druckmutter M12 mit Lager	Nut M12 with Bearing	2x		
609 420/TR20K			Spindel TR 20, kurz mit Adaptergewinde innen M10, M12, M14	Spindle TR 20, short with inside adapter thread M10, M12, M14	x	x	
609 420/TR20M			Druckmutter TR20 mit Lager	Nut TR20 with Bearing	x	x	
609 420/M10			Kontermutter M10	Counter Nut M10	x	x	
609 420/M12			Kontermutter M12	Counter Nut M12	x	x	
906 007			Spezial-Schmiermittel	Special lubricant	x	x	
609 390-1			Koffer für 609 390	Blow case for 609 390	x	x	



609 390/Basic



# EINZELTEILE FÜR DRUCK- UND ZUGHÜSENSATZ SPARE PARTS FOR PRESS AND PULL SLEEVE KIT

Art.-Nr. no.	609 420	609 420/ Upgrade	609 420/ Basic	609 400/ 460	609 400		
609 400				x	x	Druck- und Zughülsen-Satz	Pressing + Pulling Tube Kit
609 400-34/44				x	x	Druckhülse I: 34 mm A: 44 mm G1	Press-Pull Sleeve I: 34 mm A: 44 mm G1
609 400-36/46				x	x	Druckhülse I: 36 mm A: 46 mm G2	Press-Pull Sleeve I: 36 mm A: 46 mm G2
609 400-38/48				x	x	Druckhülse I: 38 mm A: 48 mm G3	Press-Pull Sleeve I: 38 mm A: 48 mm G3
609 400-40/50				x	x	Druckhülse I: 40 mm A: 50 mm G4	Press-Pull Sleeve I: 40 mm A: 50 mm G4
609 400-42/52				x	x	Druckhülse I: 42 mm A: 52 mm G1	Press-Pull Sleeve I: 42 mm A: 52 mm G1
609 400-44/54				x	x	Druckhülse I: 44 mm A: 54 mm G2	Press-Pull Sleeve I: 44 mm A: 54 mm G2
609 400-46/56				x	x	Druckhülse I: 46 mm A: 56 mm G3	Press-Pull Sleeve I: 46 mm A: 56 mm G3
609 400-48/58				x	x	Druckhülse I: 48 mm A: 58 mm G4	Press-Pull Sleeve I: 48 mm A: 58 mm G4
609 400-50/60				x	x	Druckhülse I: 50 mm A: 60 mm G1	Press-Pull Sleeve I: 50 mm A: 60 mm G1
609 400-52/62				x	x	Druckhülse I: 52 mm A: 62 mm G2	Press-Pull Sleeve I: 52 mm A: 62 mm G2
609 400-54/64				x	x	Druckhülse I: 54 mm A: 64 mm G3	Press-Pull Sleeve I: 54 mm A: 64 mm G3
609 400-56/66				x	x	Druckhülse I: 56 mm A: 66 mm G4	Press-Pull Sleeve I: 56 mm A: 66 mm G4
609 400-58/68				x	x	Druckhülse I: 58 mm A: 68 mm G1	Press-Pull Sleeve I: 58 mm A: 68 mm G1
609 400-60/70				x	x	Druckhülse I: 60 mm A: 70 mm G2	Press-Pull Sleeve I: 60 mm A: 70 mm G2
609 400-62/72				x	x	Druckhülse I: 62 mm A: 72 mm G3	Press-Pull Sleeve I: 62 mm A: 72 mm G3
609 400-64/74				x	x	Druckhülse I: 64 mm A: 74 mm G4	Press-Pull Sleeve I: 64 mm A: 74 mm G4
609 400-66/76				x	x	Druckhülse I: 66 mm A: 76 mm G1	Press-Pull Sleeve I: 66 mm A: 76 mm G1
609 400-68/78				x	x	Druckhülse I: 68 mm A: 78 mm G2	Press-Pull Sleeve I: 68 mm A: 78 mm G2
609 400-70/80				x	x	Druckhülse I: 70 mm A: 80 mm G3	Press-Pull Sleeve I: 70 mm A: 80 mm G3
609 400-72/82				x	x	Druckhülse I: 72 mm A: 82 mm G4	Press-Pull Sleeve I: 72 mm A: 82 mm G4
609 400/D10	2x	2x		2x	2x	Druckmutter M10 mit Lager	Nut M10 with Bearing
609 400/D12	2x	2x		2x	2x	Druckmutter M12 mit Lager	Nut M12 with Bearing
609 400/D14	2x	2x		2x	2x	Druckmutter M14 mit Lager	Nut M14 with Bearing
609 400/D16				2x	2x	Druckmutter M16 mit Lager	Nut M16 with Bearing
609 400/K						Koffer für 609 400	Blow Case for 609 400
609 400/P1				x	x	Stufenplatte Nr. 1 Gr. 34, 42, 50, 58, 66	Step Disc No. 1 Size: 34, 42, 50, 58, 66
609 400/P2				x	x	Stufenplatte Nr. 2 Gr. 36, 44, 52, 60, 68	Step Disc No. 2 Size: 36, 44, 52, 60, 68
609 400/P3				x	x	Stufenplatte Nr. 3 Gr. 38, 46, 54, 62, 70	Step Disc No. 3 Size: 38, 46, 54, 62, 70
609 400/P4				x	x	Stufenplatte Nr. 4 Gr. 40, 48, 56, 64, 72	Step Disc No. 4 Size: 40, 48, 56, 64, 72
609 400/S10	x	x		x	x	Spindel M10 ohne Mutter	Spindle M10 without Nut
609 400/S12	x	x		x	x	Spindel M12 ohne Mutter	Spindle M12 without Nut
609 400/S14	x	x		x	x	Spindel M14 ohne Mutter	Spindle M14 without Nut
609 400/S16	x	x		x	x	Spindel M16 ohne Mutter	Spindle M16 without Nut
609 400/460-C				x		Koffer für 609 400/460	Blow Case for 609 400/460
609 420						Druck- und Zughülsen-Satz II	Pressing + Pulling Tube Kit II
609 420-1	x		x			Koffer für 609 420	Blow Case for 609 420
609 420-100/110	x		x			Druckhülse I: 100 mm A: 110mm G2	Press-Pull Sleeve I: 100 mm A: 110 mm G2
609 420-102/112	x		x			Druckhülse I: 102 mm A: 112 mm G3	Press-Pull Sleeve I: 102 mm A: 112 mm G3
609 420-104/114	x		x			Druckhülse I: 104 mm A: 114 mm G4	Press-Pull Sleeve I: 104 mm A: 114 mm G4
609 420-106/116	x	x				Druckhülse I: 106 mm A: 116 mm G1	Press-Pull Sleeve I: 106 mm A: 116 mm G1
609 420-108/118	x	x				Druckhülse I: 108 mm A: 118 mm G2	Press-Pull Sleeve I: 108 mm A: 118 mm G2
609 420-110/120	x	x				Druckhülse I: 110 mm A: 120 mm G3	Press-Pull Sleeve I: 110 mm A: 120 mm G3
609 420-112/122	x	x				Druckhülse I: 112 mm A: 122 mm G4	Press-Pull Sleeve I: 112 mm A: 122 mm G4
609 420-74/84	x	x				Druckhülse I: 74 mm A: 84 mm G1	Press-Pull Sleeve I: 74 mm A: 84 mm G1
609 420-76/86	x	x				Druckhülse I: 76 mm A: 86 mm G2	Press-Pull Sleeve I: 76 mm A: 86 mm G2
609 420-78/88	x	x				Druckhülse I: 78 mm A: 88 mm G3	Press-Pull Sleeve I: 78 mm A: 88 mm G3
609 420-80/90	x	x				Druckhülse I: 80 mm A: 90 mm G4	Press-Pull Sleeve I: 80 mm A: 90 mm G4
609 420-82/92	x		x			Druckhülse I: 82 mm A: 92 mm G1	Press-Pull Sleeve I: 82 mm A: 92 mm G1
609 420-84/94	x		x			Druckhülse I: 84 mm A: 94 mm G2	Press-Pull Sleeve I: 84 mm A: 94 mm G2
609 420-86/96	x		x			Druckhülse I: 86 mm A: 96 mm G3	Press-Pull Sleeve I: 86 mm A: 96 mm G3
609 420-88/98	x		x			Druckhülse I: 88 mm A: 98 mm G4	Press-Pull Sleeve I: 88 mm A: 98 mm G4
609 420-90/100	x	x				Druckhülse I: 90 mm A: 100 mm G1	Press-Pull Sleeve I: 90 mm A: 100 mm G1
609 420-92/102	x	x				Druckhülse I: 92 mm A: 102 mm G2	Press-Pull Sleeve I: 92 mm A: 102 mm G2
609 420-94/104	x	x				Druckhülse I: 94 mm A: 104 mm G3	Press-Pull Sleeve I: 94 mm A: 104 mm G3
609 420-96/106	x	x				Druckhülse I: 96 mm A: 106 mm G4	Press-Pull Sleeve I: 96 mm A: 106 mm G4
609 420-98/108	x		x			Druckhülse I: 98 mm A: 108 mm G1	Press-Pull Sleeve I: 98 mm A: 108 mm G1
609 420/A	2x		2x			Druckadapter für Stufenplatten	Adapter for Step Discs
609 420/Basic			x			Druck- und Zughülsensatz II (Grundausrüstung)	Pressing + Pulling Tube Kit II (Basic)
609 420/D16	2x	2x				Druckmutter M16 mit Lager	Nut M16 with Bearing
609 420/M10	x		x			Kontermutter M10	Counter Nut M10
609 420/M12	x		x			Kontermutter M12	Counter Nut M12
609 420/M14	x		x			Kontermutter M14	Counter Nut M14
609 420/P1	x		x			Stufenplatte Nr. 1 Gr. 74, 82, 90, 98, 106	Step Disc No. 1 Gr. 74, 82, 90, 98, 106
609 420/P2	x		x			Stufenplatte Nr. 2 Gr. 76, 84, 92, 100, 108	Step Disc No. 2 Gr. 76, 84, 92, 100, 108
609 420/P3	x		x			Stufenplatte Nr. 3 Gr. 78, 86, 94, 102, 110	Step Disc No. 3 Gr. 78, 86, 94, 102, 110
609 420/P4	x		x			Stufenplatte Nr. 4 Gr. 80, 88, 96, 104, 112	Step Disc No. 4 Gr. 80, 88, 96, 104, 112
609 420/TR20K	x		x	x		Spindel TR 20, kurz mit Adaptergewinde innen M10, M12, M14	Spindle TR 20, short with inside adapter thread M10, M12, M14
609 420/TR20L	x		x			Spindel TR 20, lang mit Adaptergewinde innen M10, M12, M14	Spindle TR 20, long with inside adapter thread M10, M12, M14
609 420/TR20M	x		x	x		Druckmutter TR20 mit Lager	Nut TR20 with Bearing
609 420/Upgrade		x				Druck- und Zughülsensatz II (Ergänzungssatz) 12x Hülse + 4 Spindeln mit Druckmutter	Pressing + Pulling Tube Kit II (Upgrade)

Fahrwerk Suspension  
 2  
 Bremse & Rad Brake & Wheel  
 3  
 Motor Engine-Tools  
 4  
 Zerspanung Cutting Tools  
 5  
 Karosserie/Verschleiß AutoBody/Consumables  
 6  
 Universal-Werkzeuge Universal Tools  
 7  
 Transporter & LKW Heavy Duty & Trucks  
 8  
 Equipment  
 9  
 Inhaltsverzeichnis Table of Contents

# XS DRUCK- UND ZUGHÜSENSATZ XS PRESS AND PULL SLEEVE KIT



**Druckhülsen Ø Innen:**  
14 - 32 mm    9/16" - 1-1/4"  
Sleeves Ø inner from:  
14 - 32 mm    9/16" - 1-1/4"



**Hochwertige Spindel**  
Spindle with rolled thread

**Druck-/Zughülse**  
Sleeve

**Querlenker**  
Control arm

**Stufenscheibe**  
Hardened Step Disc

**Druck-/Zughülse**  
Sleeve

**Druckmutter mit Lager**  
Nut with Ball Bearing

**Hülsen können mit Nr. 609 400 kombiniert werden.**  
Sleeves can be stacked with no. 609 400 sleeves



**Universal Werkzeugsatz zum Aus- und Einziehen** von Silentlagern, Hydrolagern, Buchsen, Kugellagern, Simmerringen, Gummilagern und Traggelenken. Verwendbar als Präzisions-Druckstücke für die Werkstattpresse. Kombinierbar mit Pressrahmen, C-Bügel etc. Ideal auch zur Verwendung mit dem Original MÜLLER Druck- und Zughülsensatz 609 400.

**Nr. 609 390**  
Code: OE398000398

**XS Druck- und Zughülsensatz**

**Nr. 609 390/Basic XS Ergänzungssatz für Nr. 609 400**



**Universal tool set for extracting and mounting:** silent bearings, hydraulic bearings, ball bearings, rubber bearings, shaft seals, bearing bushes, etc. Universal application makes it ideal for a range of vehicles. Ideal to use in combination with the 609 400 press and pull sleeve kit.

**XS press and pull sleeve kit**  
(10 sleeves, 3 spindles, 4 discs)

**Basic XS press and pull sleeve kit**  
(10 sleeves, 1 spindle) **Kombi kit for no. 609 400**

OPTION HYDRAULIK  
 ab Seite 2-60  
 OPTION HYDRAULIC  
 on page 2-60

**UNIVERSAL DRUCK- UND ZUGHÜSENSATZ BASIC**  
**UNIVERSAL PRESS AND PULL SLEEVE KIT BASIC**

BASIC Druckhülse / Press Pull Sleeve	
Innen / inner Ø	Außen / outside Ø
34 mm	44 mm
42 mm	52 mm
44 mm	54 mm
46 mm	56 mm
52 mm	62 mm
64 mm	74 mm
70 mm	80 mm
72 mm	82 mm



**Druckhülsen Ø Innen:**  
**34 - 72mm**  
 Sleeves inner Ø: 34 - 72mm



 **Universal Werkzeugsatz** zum Aus- und Einziehen von: Silentlagern, Hydrolagern, Buchsen, Kugellagern, Simmerringen, Gummilagern etc. Absolut universelle Anwendung. Ideal für unterschiedliche Fahrzeuge, Transporter und LKW.

 **Universal tool set** for extracting and mounting in: silent bearings, hydraulic bearings, bearing bushes, ball bearings, shaft seals, rubber bearings etc. Fully universal application. Ideal for different vehicles.

**Nr. 609 399 Universal Druck- und Zughülsensatz Basic**  
 Code: OE318000318

**Universal press and pull sleeve kit basic**

Fahrwerk / Suspension  
 2  
 Bremse & Rad / Brake & Wheel  
 3  
 Motor / Engine-Tools  
 4  
 Zerspanung / Cutting Tools  
 5  
 Karosserie/Verschleiß / AutoBody/Consumables  
 6  
 Universal-Werkzeuge / Universal Tools  
 7  
 Transporter & LKW / Heavy Duty & Trucks  
 8  
 Equipment  
 9  
 Inhaltsverzeichnis / Table of Contents

## UNIVERSAL DRUCK- UND ZUGHÜSENSATZ TYP 1 UNIVERSAL PRESS AND PULL SLEEVE KIT TYPE 1



**Druckhülsen Ø Innen: 34 - 72mm**  
Sleeves inner Ø: 34 - 72mm

WATCH DEMO HERE:



**Universal Werkzeugsatz** zum Aus- und Einziehen von: Silentlagern, Hydrolagern, Buchsen, Kugellagern, Simmerringen, Gummilagern etc. Absolut universelle Anwendung. Ideal für unterschiedliche KFZ.

**Nr. 609 400 Universal Druck- und ZughüSENSATZ Typ 1**  
Code: OE498000498



**Universal tool set** for extracting and mounting in: silent bearings, hydraulic bearings, bearing bushes, ball bearings, shaft seals, rubber bearings etc. Fully universal application. Ideal for different vehicles.

**Universal press and pull sleeve kit type 1**

OPTION HYDRAULIK  
ab Seite 2-60

OPTION HYDRAULIC  
on page 2-60

**UNIVERSAL DRUCK- UND  
ZUGHÜLSEN-KOMPLETTSATZ**  
UNIVERSAL PRESS AND  
PULL COMBINATION KIT



WATCH DEMO HERE:



Dieser Satz vereint in einem Koffer unseren Universal Druck- und Zughülsensatz (Nr. 609 400) und unseren original **VIBRO-IMPACT®** C-Bügel (Nr. 609 460). Zusätzlich enthält dieser Satz noch eine kurze Trapezgewinde-Spindel TR20 mit Druckmutter, sowie die entsprechenden Konter-Muttern.

**Anwendungen z. B.:**

- Silentlager
- Kugellager
- Radlager
- Gummi-Lager
- Hydro-Lager
- Dichtungen
- etc.



**The #1 Press & Pull kit on the market!**

- Our complete package! 20 Sleeves / 4 Discs!
- Sleeves can be stacked.
- Sleeves outer diameter range: 1-3/4" – 3-1/8"
- Including XL C-Clamp
- Includes **VIBRO-IMPACT®** Tool, allowing the use of an impact wrench
- Comes in a convenient carry case.

**Applications:**

- Remove/Install:
- Silent Bearings
  - Ball Bearings
  - Rubber Bearings
  - Hydraulic Bearings
  - Shaft Seals/Bearing Bushings
  - etc.

**Nr. 609 400/460 Universal Druck- und  
Zughülsen-Komplettatz**  
Code: OE94800948

**Press and Pull Sleeve Combination Kit**

Fahrwerk / Suspension  
2  
Bremse & Rad / Brake & Wheel  
3  
Motor / Engine-Tools  
4  
Zerlegung / Cutting Tools  
5  
Karosserie / Verschleiß / AutoBody / Consumables  
6  
Universal-Werkzeuge / Universal Tools  
7  
Transporter & LKW / Heavy Duty & Trucks  
8  
Equipment  
9  
Inhaltsverzeichnis / Table of Contents



## UNIVERSAL DRUCK- UND ZUGHÜSENSATZ TYP 2 UNIVERSAL PRESS AND PULL SLEEVE KIT TYPE 2



**Druckhülsen Ø Innen: 74 - 112mm**  
Sleeves inner Ø: 74 - 112mm



**Universal Werkzeugsatz** zum Aus- und Einziehen von: Silentlagern, Hydrolagern, Buchsen, Kugellagern, Simmeringen, Gummilagern etc. Absolut universelle Anwendung. Ideal für unterschiedliche Fahrzeuge, Transporter und LKW.

**Nr. 609 420 Universal Druck- und ZughüSENSATZ Typ 2**  
Code: OE138001380



**Universal tool set** for extracting and drawing in: silent bearings, hydraulic bearings, bearing bushes, ball bearings, shaft seals, rubber bearings etc. Fully universal application. Ideal for different vehicles, heavy duty and trucks.

**Universal press and pull sleeve kit type 2**

OPTION HYDRAULIK  
ab Seite 2-60

OPTION HYDRAULIC  
on page 2-60

**UNIVERSAL DRUCK- UND ZUGHÜSENSATZ TYP 2**  
**UNIVERSAL PRESS AND PULL SLEEVE KIT TYPE 2**



**Nr. 609 420/Basic**



**Spindel TR20, lang mit Adaptergewinde innen**  
**M10 + M12 + M14**  
Spindle TR20 long with inner adapter threads

**Spindel TR20, kurz mit Adaptergewinde innen**  
**M10 + M12 + M14**  
Spindle TR20 short with inner adapter threads

**Exakte Hülsevenlängerung durch Abstufung**

Sleeves can be stacked

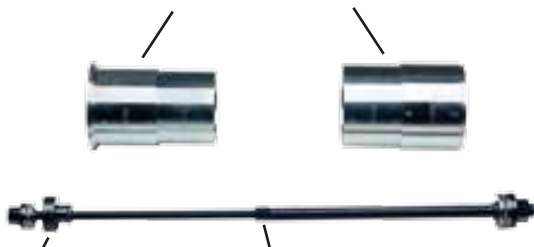

**Druckadapter für Stufenscheibe**

Press adapter for step disc

**Kontermutter für Spindelverlängerung TR20**

Counter nut to extend spindle



**Nr. 609 420/Upgrade**

**M10, M12, M14, M16**

**Nr. 609 420/Basic**  
Code: OE828000828

**Druck- und Zughülzensatz Typ 2 Basic**

(8x Druckhülsen, 4x Druckplatten, 1x Spindel TR20 lang, 1x Spindel TR20 kurz, 2x Druckmutter TR20, 3x Kontermutter, 1x Spindelfett)

**Nr. 609 420/Upgrade Druck- und Zughülzensatz Typ 2 Upgrade**  
Code: OE648000648

(12x Druckhülsen, 4x Spindel mit Druckmutter)



**Universal press and pull sleeve kit type 2 basic**

(8x press-pull sleeves, 4x step discs, 1x spindle TR20 long, 1x spindle TR20 short, 2x nuts TR20, 3x counter nuts, 1x spindle lubricant)

**Universal press and pull sleeve kit type 2 upgrade**

(12x press-pull sleeves, 4x spindles with nuts)

Fahrwerk Suspension  
2  
Brems- & Rad Brake & Wheel  
3  
Motor Engine-Tools  
4  
Zerlegung Cutting Tools  
5  
Karosserie/Verschleiß AutoBody/Consumables  
6  
Universal-Werkzeuge Universal Tools  
7  
Transporter & LKW Heavy Duty & Trucks  
8  
Equipment  
9  
Inhaltsverzeichnis Table of Contents

## C-BÜGEL PRESSWERKZEUG DB W211 + W220 BALL JOINT C-CLAMP DB W211 + W220

*original*  
**VIBRO-IMPACT®**

### Traggelenk / Ball joint



**Nr. 609 450**  
**C-Bügel Grundgerät**  
Basic C-clamp

#### Nr. 609 472

**Druckstücke für Traggelenke DB W211+ W220**  
Adapter for ball joint DB W211 + W220



### Drehstabgelenk / Torsion ball joint

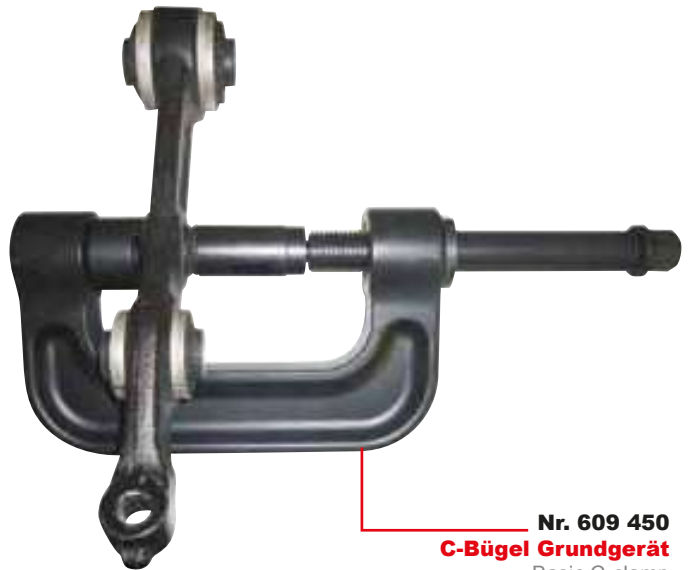

**Nr. 609 450**  
**C-Bügel Grundgerät**  
Basic C-clamp

#### Nr. 609 471

**Druckstücke für Drehstabgelenke DB W211+ W220**  
Adapter for torsion ball joint  
DB W211 + W220



**Schneller und problemloser Aus- und Einbau** der unteren Traggelenke direkt am Fahrzeug. Teilweise auch ohne Ausbau der Querlenker und Bremsscheiben.

**Nr. 609 450 Grundgerät C-Bügel, klein**

Code: OE288000288

**Nr. 609 471 Druckstücksatz Drehstabgelenk**

Code: OE940000094

**Nr. 609 472 Druckstücksatz Traggelenk**

Code: OE138000138



**Rapid and trouble-free removal and fitting** of the lower supporting joints on the vehicle. At some types even without removing the wishbones and brake discs.

**Basic C-clamp, small**

**Adapter kit torsion ball joint**

**Adapter kit ball joint**

## UNIVERSAL C-BÜGEL TYP 2 UNIVERSAL C-FRAME TYPE 2

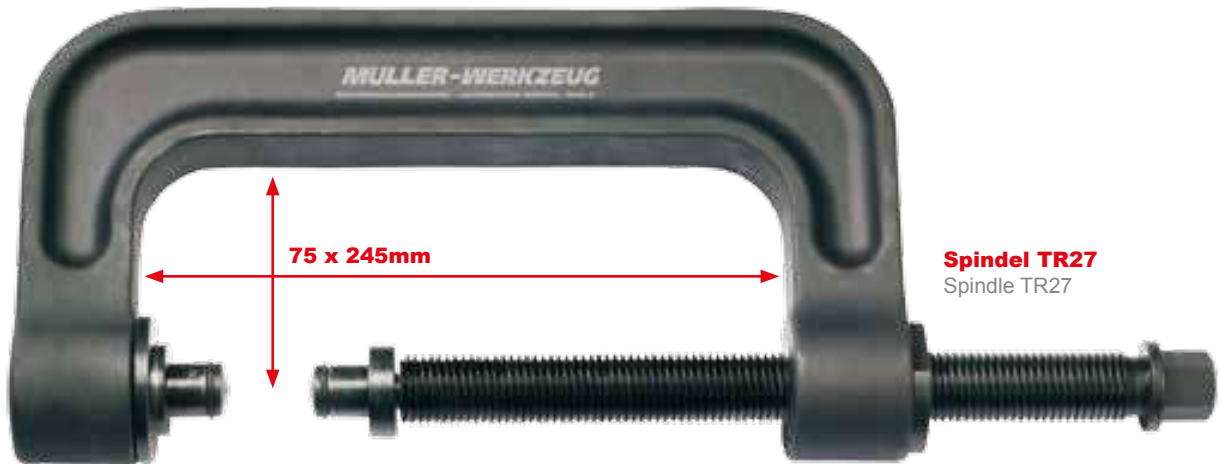

**Nr. 609 460**

**Kugelgelagerte Druckstücke, passend für Stufenscheiben**

Ball beared press adapters, fit for step discs

**Spindel TR27**  
Spindle TR27

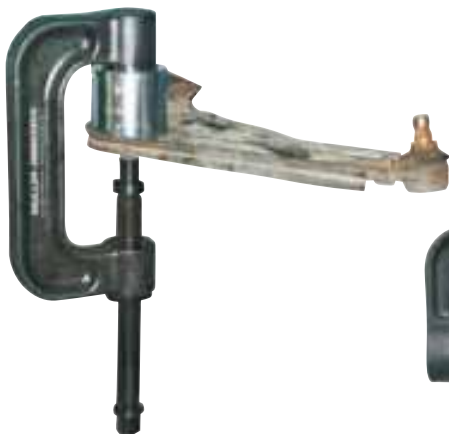

**Nr. 609 455 + Nr. 609 400**

**Anwendungsbeispiel:  
C-Bügel Typ 1 + Druck-  
und Zughülzensatz**

Example of use:  
C-Frame type 1 + press and  
pull sleeve kit



**Nr. 609 460 + 609 400**

**Anwendungs-Option: C-Bügel + Druck- und  
Zughülzensatz**

Example of use: C-Frame + press and pull sleeve kit



**Anwendungs-Option:  
C-Bügel inkl. 12 to.  
Hydraulik- Spindel**

Example of use: C-Frame  
incl. 12 to. Hydraulic spindle



**Universell passender, am Fahrzeug einsetzbarer  
C-Bügel** zum Aus- und Einbau von Tragelenken, Silent-  
lagern, Stoßdämpferaugen etc. Ideal für schwer zugängliche  
Anwendungen.

**Nr. 609 460 Universal C-Bügel Typ 2**

Code: OE418000418



**Heavy duty, drop-forged C-Frame for use with no.  
609 400.** Ideal for restricted access areas. Can also be used  
with hydraulic spindle. Impact wrench safe. Allows greater ap-  
plication of force.

**Universal C-Frame type 2**

# 10 to. INTEGRAL-HYDRAULIKSPINDEL COMBINED HYDRAULIC SPINDLE

**TOOL-INNOVATION  
2016**



**Neuartige und innovative Hydraulikspindel mit integrierter Hochdruckpumpe und einem Lasthub von 85mm.** Messbare 10 Tonnen Druckleistung. Alle uns bekannten Fett- und Öl-Hydraulikspindeln haben nur einen Lasthub zwischen 5 und 12 mm. Handgriff ist 360° drehbar und abnehmbar. Das integrierte Überdruck-Sicherheitsventil öffnet ab 10 Tonnen und die Einheit kann nicht überlastet werden. Die Ölhydraulik funktioniert in jeder Position, also auch über Kopf. Für den Kolben mit Federrückzug gibt es optional auch weitere Druckstücke. Passend für alle am Markt gängigen Abzieher, Flansche, Vorrichtungen etc... mit Gewinde UN1-1/2". Also z. B. auch passend für Sauer, Sykes Pickavant, KS-Tools, Friweg, FW-Hanse, Kukko, Nexus, Facom, DB, MAN...

**Nr. EQ-609 710 Integral-Hydraulikspindel 10 to.**  
Code: OE398000398

**Nr. EQ-609 710/3 Integral-Hydraulikspindel 3er Pack**  
Code: OE119401194



**Unique and combined high pressure pump and hydraulic spindle 10 tons and a stroke of 85mm.** Measurable 10 tons of pressure capacity. All the hydraulic spindles we know, which operate with oil or grease, only have a stroke of 5 to 12 mm. The handle can be rotated 360° and is removable. The integrated pressure relief control valve opens at 10 tons and the unit cannot be overloaded. The oil hydraulics works in any position, even upside down. The piston has a spring return, and optional additional plungers are available.

Suitable for use with all available current market pullers, flanges, fixtures etc., with thread UN 1-1/2".

Therefore, e.g. suitable for Sauer, Sykes Pickavant, KS-Tools, Friweg, FW-Hanse, Kukko, Nexus, Facom, DB, MAN etc.

**Nr. EQ-609 710 Combined Hydraulic Spindle 10 tons.**  
Code: OE398000398

**Nr. EQ-609 710/3 Combined Hydraulic spindles, pack of 3**  
Code: OE119401194

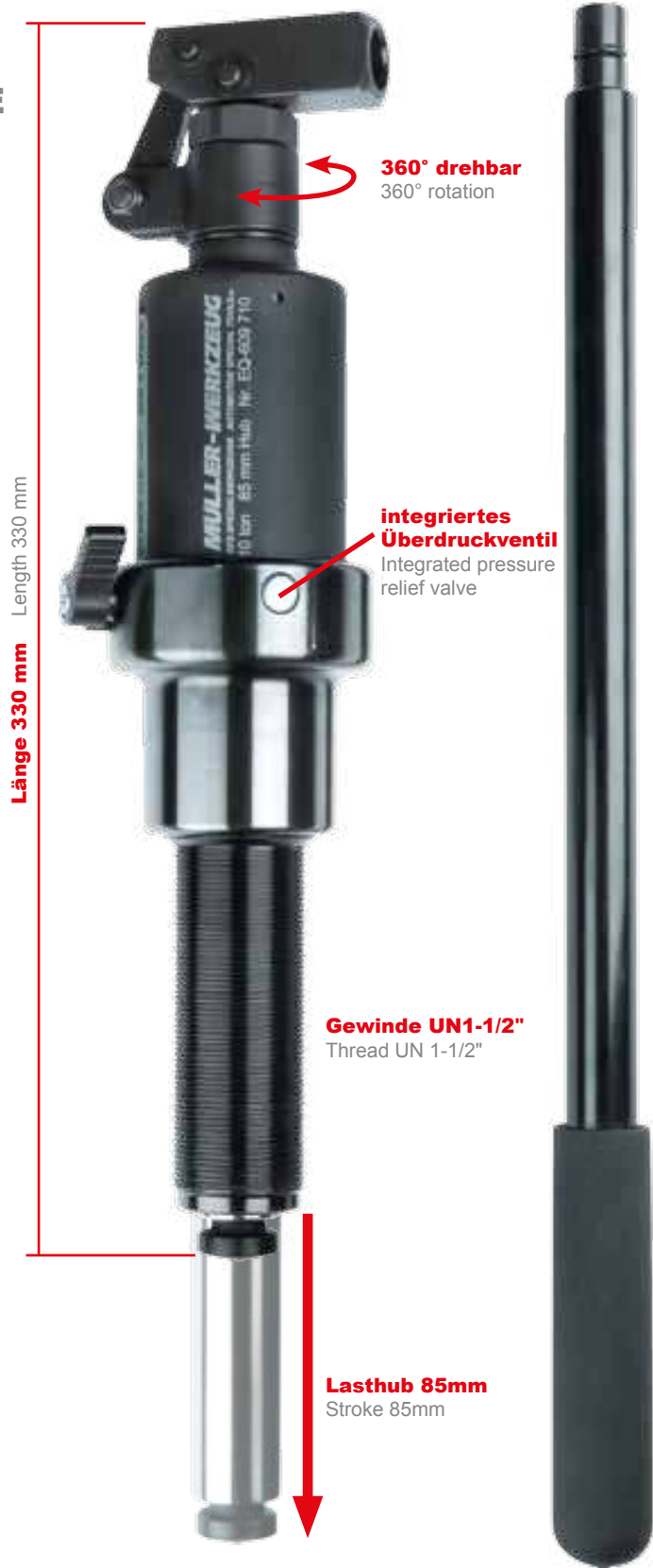

Fahrwerk  
Suspension

2

Bremse & Rad  
Brake & Wheel

3

Motor  
Engine-Tools

4

Zerspanung  
Cutting Tools

5

Karosserie/Aerschleiß  
AutoBody/Consumables

6

Universal-Werkzeuge  
Universal Tools

7

Transporter & LKW  
Heavy Duty & Trucks

8

Equipment

9

Inhaltsverzeichnis  
Table of Contents

**UNIVERSAL-ANWENDUNGEN**  
**UNIVERSAL SYSTEM**

Optional Nr. 609 460-4:  
Adapter für Stufenscheiben  
aus Nr. 609 400  
Adapter for stepped pulleys  
from No. 609 400



Fahrwerk  
Suspension

2

Bremse & Rad  
Brake & Wheel

3

Motor  
Engine-Tools

4

Zerspanung  
Cutting Tools

5

Karosserie/Verschleiß  
AutoBody/Consumables

6

Universal-Werkzeuge  
Universal Tools

7

Transporter & LKW  
Heavy Duty & Trucks

8

Equipment

9

Inhaltsverzeichnis  
Table of Contents



**2/3 Arm Abzieher**  
**z. B. Sturzeinstellplatte /**  
**Lenkstockhebel**  
2/3 legs pullers  
e.g. Wheel camber setting plates  
and Steering/pitman arms



**Universal Pressrahmen**  
Universal Press frame

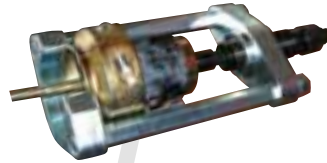

**Aus- und Einbau**  
**Silentlager am Fahrzeug**  
Removal and installation  
of suspension bushes/silent  
bearings, on the vehicle



**Abzieher Schwingungsdämpfer**  
Extraction of vibration dampers



**Kombination mit Druck-**  
**und Zughülensätzen**  
Combination with pressure sleeve  
and clamping sleeve sets



**LKW**  
**Kugelgelenk-**  
**abdrücker**  
Truck ball  
joint splitter

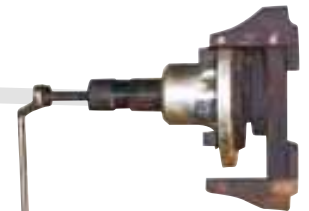

**Antriebswelle aus**  
**Radnabe drücken**  
Pressing the drive shaft  
from the wheel hub



**Flanche**  
Flanges



**C-Bügel**  
C-frame

## C-BÜGEL UND PRESSRAHMEN-SATZ C-FRAME AND BASE FRAME KIT



Nr. 609 465



Nr. 609 316  
Seite / page 2-39



Nr. 609 460  
Seite / page 2-52



**C-Bügel Typ 2.** Universell passender, am Fahrzeug einsetzbarer C-Bügel zum Aus- und Einbau von Traggelenken, Silentlagern, Stoßdämpferaugen etc. Ideal für schwer zugängliche Anwendungen.

**Universal Pressrahmen.** Universell am Fahrzeug einsetzbares Grundgerät zum Aus- und Einbau z. B. von Traggelenken (Kugelbolzen), Silentlagern (Metall- / Gummilager) z. B. BMW, DB, Audi, Renault, VW, Mazda etc. Auswechselbare 6-kant Stangen in verschiedenen Ausführungen und Längen lieferbar.

**Nr. 609 465 C-Bügel und Pressrahmen-Satz**  
Code: OE898000898



**C-Frame type 2.** Complementary tool for use with no. 609 400. Ideal for restricted access areas. Can also be used with hydraulic spindle. Impact wrench safe. Allows greater application of force.

**Universal base frame.** Universal use directly on the car. For removing and installing of ball joints, rubber bushings for example at BMW, DB, Audi, Renault, VW, Mazda etc. Interchangeable hex rods in different lengths available.

**C-Frame and base frame kit**

## UNIVERSAL LAGERRINGABZIEHER UNIVERSAL RACE RING PULLER

 **PATENTIERT**

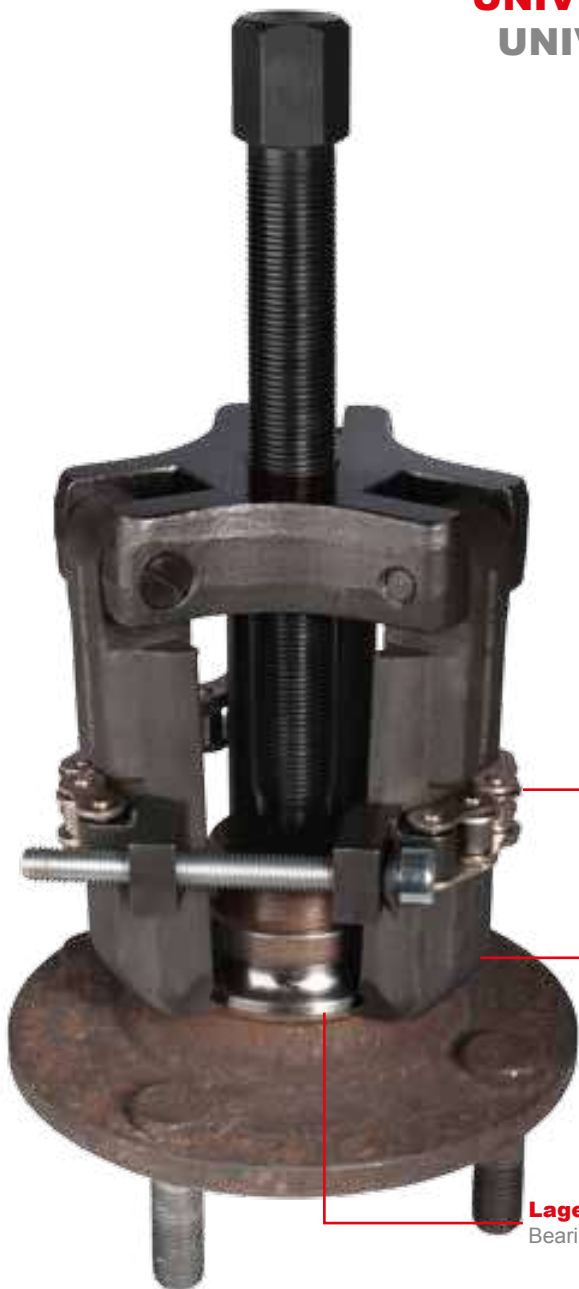

**Spannkette sichert den festen Sitz des Abziehers**  
Fully grip based on the clamping-chain

**Greif-Schneidkanten greifen den 0,5mm Radius des Lagerringes**  
Cutting edges will be pressed into the 0,5mm radius at the ring.

**Spannbereich: 40 - 60mm**  
Clamping range: 40 - 60mm

**Lager-Innenring auf Radnabe**  
Bearing ring at the wheel hub



**Universal-Lagerringabzieher mit neuartigem Greifprinzip.** Die 3-schneidige Ausführung sorgt für gleichmäßige Kräfteverteilung. Dadurch kein Verkanten des Lagerringes. Durch nochmaliges Nachspannen der Kette wird die Lagerschale voll hintergriffen und kann abgezogen werden. Lieferung im Koffer. Spannbereich 40-60mm. Patent.

**Nr. 650 200 Universal Lagerringabzieher**  
Code: OE258000258



**Universal bearing ring puller** with new gripping principle. The Gripping principle is the 3-leg with cutting edges, so same pressing power at each side. Based on that tilt is excluded. Fits for bearing rings (races), and all kind of bearings and sleeves 40-60mm. Patent.

**Universal race ring puller**





## LAGERRINGABZIEHER VW-GRUPPE NEU BEARING RACE PULLER VW/AUDI

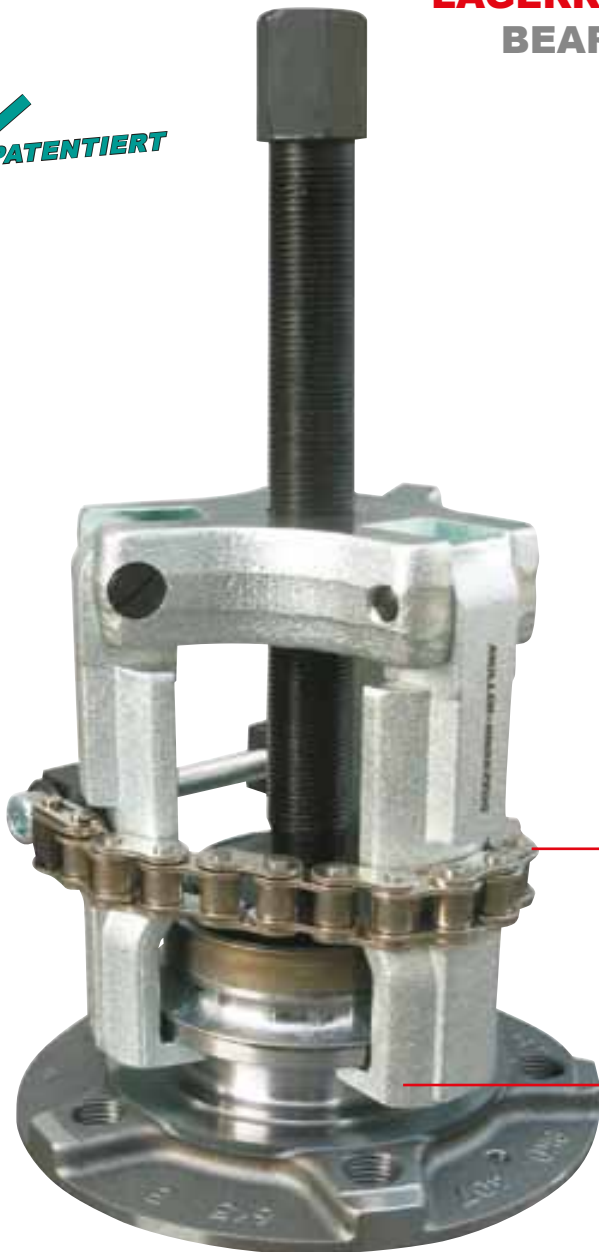

### Spannkette sichert den festen Sitz

Fully grip based on the clamping chain

### Lagerschale wird voll hintergriffen

Fully grip of the race ring

### z. B. passend für / e.g. fits for:

Audi A4 ab 2008  
Audi A4 Allroad Quattro ab 2010  
Audi A4 Quattro ab 2008  
Audi A5 Cabrio ab 2010  
Audi A5 Coupé ab 2008  
Audi A6 ab 2011

Audi A6 Quattro ab 2011  
Audi A7 ab 2011  
Audi A8 ab 2010  
Audi A8 Quattro ab 2010  
Audi Q5 ab 2009  
Audi RS 5 ab 2010



**Lagerringabzieher** zum einfachen und sicheren Abziehen des inneren Lagerringes der neuartigen Radlager der VW-Gruppe. Kein Verkanten durch dreiarmliges Abziehsystem. Lagerschale wird voll hintergriffen und kann durch gleichmäßige Kraftverteilung sicher und schnell abgezogen werden. Spannkette sichert den festen Sitz des Abziehers.

**Nr. 650 210 Lagerringabzieher VW-Gruppe Neu**

Code: OE258000258



**Bearing race puller** for the easy and safe pulling of the new race rings of the VW/AUDI. Fully grip of the bearing ring, so same pressing power at each side. Fully grip based on the clamping chain.

**Bearing race puller VW/AUDI**

## ABZIEHSYSTEM FÜR LAGERRINGE PULLING SYSTEM FOR BEARING RINGS

 **PATENTIERT**



**Neues Prinzip: Federring - Kegelscheibe**  
New principle: Spring ring - Cone disc

**Eingelegter Federring**  
Mounted spring ring

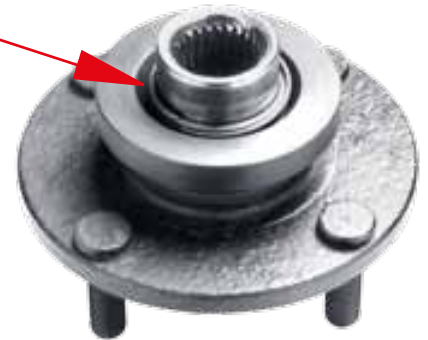

WATCH DEMO HERE:

**Lieferumfang: Komplettsatz in Holzkiste für 95% aller PKW.**  
Shipment: Kit in wooden-box. Fits for 95% of cars.



**Angriffspunkt:  
Nut- oder Lauffläche**  
Contact-point:  
groove- or bearing race

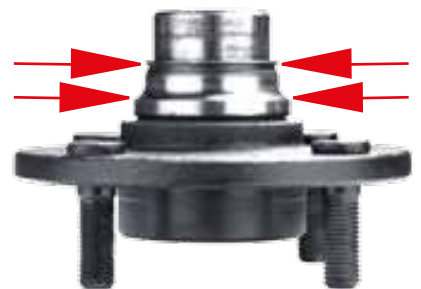

**Vollkommen neuartiges Lagerring-Abziehsystem.**  
Federring - Kegelscheibe wird in die Lagerlauffläche oder in vorhandene Nut angebracht. Die Abziehkraft wirkt radial und gleichmäßig über den Federring. Die mitgelieferte Spannkette sorgt für den exakten Sitz des Abziehers.



**New pulling system for bearing rings.** Spring ring - Cone disc.

**Nr. 650 400 Abziehsystem für Lagerringe**  
Code: OE468000468

**Pulling system for bearing rings**

## IMPACT GELENKWELLEN 12-KANT-SATZ IMPACT AXLE SHAFT 12-POINT-KIT



**Stecknuss Satz 9 tlg., Schlagausführung** speziell zum Lösen und Anziehen der 12-kant Muttern auf den Antriebswellen. Alle benötigten 12-kant Spezialstecknüsse SW 24, 27, 30, 32, 34, 36 x 1/2" Länge 85 mm für überstehende Gelenkwellingewinde. Lösen und Anziehen des Innen 6-kant Profiles in den Gelenkwellen. Innen 6-kant Stecknüsse SW 14, 17, 19 x 1/2", extra kurz, Länge 34 mm. Komplett im stabilen Kunststoff-Ordnungssystem

**Nr. 810 500/9 IMPACT Gelenkwellen 12-Kant-Satz, 9-tlg.**  
Code: OE128000128



**Impact socket kit 12-point.** Especially made to loose and tight the axle shaft nuts. Hex sockets for the inner profile. Will be supplied with plastic storage.

**Nr. 810 500/9 IMPACT Axle shaft 12-point-kit, 9 pcs.**  
Code: OE128000128



## DUO DRIVE®

### STECKNUSS-SATZ SOCKET KIT



Das **DUO DRIVE®** System ermöglicht den Einsatz verschiedener Schlagschrauber (z.B. 1/2", 3/4" etc.), sowie die Verwendung von Ring- und Maulschlüssel etc.

**Nr. 810 808 Stecknuss-Satz XZN-Impact, 8-tlg.**  
Code: OE880000088



The **DUO DRIVE®** is made to be used with 1/2" + 3/4" impact wrenches. As well you can use it with wrenches.

**Nr. 810 808 Socket kit XZN-impact 8 pcs.**  
Code: OE880000088



**Vielzahl-Stecknuss einzeln erhältlich**  
Sockets are separately available



## HYDRAULIK HOHLKOLBEN-ZYLINDER HOLLOW PISTON HYDRAULIC-CYLINDER



**Nr. 300 120**  
**20 to. Hohlkolben-Zylinder Ø 26,0mm**  
20 to. hollow piston cylinder Ø 26,0mm



**Nr. 300 013**  
**12 to. Hohlkolben-Zylinder Ø 19,0mm**  
12 to. hollow piston cylinder Ø 19,0mm



**Nr. 300 015**  
**700 bar Hydraulik-Schlauch, 2m**  
700 bar hydraulic-hose, 2m



**Nr. 300 011**  
**Zugspindel M16x500mm mit Muttern und Kugelscheiben**  
Spindle M16x500mm with nuts and rounded washer



**Nr. 300 017**  
**Zugspindel M20x500mm mit Muttern und Kugelscheiben**  
Spindle M20x500mm with nuts and rounded washer



**Hydraulik-Hohlkolben-Zylinder in 12 und 20 to.** Ausführung erhältlich. Extrem hoher und gleichmäßiger Kraftaufbau. Zylinderbohrung ermöglicht sowohl Druckkraft als auch Zugkraft in Verbindung mit entsprechender Spindel.  
(12 to. Zylinder/ M16 Spindel, 20 to. Zylinder/ M20 Spindel)

**Nr. 300 013** **Hydraulik-Hohlkolbenzylinder 12 to.**  
Code: OE588000588

**Nr. 300 120** **Hydraulik-Hohlkolbenzylinder 20 to.**  
Code: OE980000980

**Nr. 300 011** **Zugspindel für Hydraulik M16 x 500mm**  
Code: OE900000090

**Nr. 300 017** **Zugspindel für Hydraulik M20 x 500mm**  
Code: OE900000090

**Nr. 300 015** **Hydraulik-Schlauch 700 bar, 2m**  
Code: OE128000128



**Hollow piston hydraulic cylinder designed in 12 to. or 20 to.** High pull or push force of 12 to. or 20 to. will be generated evenly. Hollow piston construction.  
(12 to. cylinder / M16 spindle, 20 to. cylinder / M20 spindle)

**Hollow piston 12 to.**

**Hollow piston 20 to.**

**Spindle for hydraulics M16 x 500mm**

**Spindle for hydraulics M20 x 500mm**

**Hydraulic hose 700 bar, 2m**

## HYDRAULIK-SET 20 TO. HYDRAULIC-SET 20 TO.

### Hochfeste Spindel, M20x500mm mit Muttern und Kugelscheiben

Spindle M20x500mm with  
nuts and rounded washer



**Hochdruckschlauch,  
700bar, 2m**  
Hose, 700bar, 2m

**Schnellverbindungs-  
Kupplung**  
Quick-chuck

### Pneumatik-Hydraulik-Einheit, Fußbetätigung, 700bar

Pneumatic-hydraulic-unit, foot control,  
700 bar

Nr. EQ-700

**Zylinder-Hub: 52mm**  
Cylinder-hub: 52mm



**20 to. Hydraulik-Set, ideales Kombinationswerk-  
zeug** für Druck- und Zughülzensatz Typ I+II. Hydraulik-  
Hohlkolben-Zylinder. Hoher und gleichmäßiger Kraftaufbau.  
Zylinderbohrung ermöglicht sowohl Druckkraft als auch Zug-  
kraft in Verbindung mit entsprechender Spindel.  
Optional: Spindel in verschiedenen Längen lieferbar.

**Nr. EQ-320/700 Hydraulik-Set pneumatisch 20 to.**  
Code: OE117601176  
Lieferung komplett in Box.



**20 to. Hydraulic-set. Perfect combination-tool** for  
press and pull sleeve kit type I+II. High pull or push of 20 to.  
will be generated evenly. Hollow piston construction. 700 bar  
foot pump.

**Hydraulic-set with pneumatic pump 20 to.**

## HYDRAULIK-ANTRIEB HYDRAULIC-OPERATION



Nr. 300 015



Nr. EQ-300 014

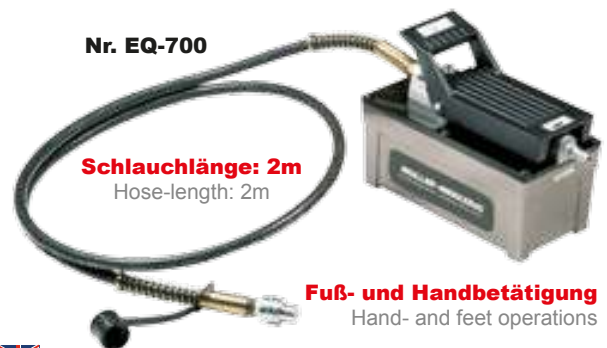

Nr. EQ-700

**Schlauchlänge: 2m**  
Hose-length: 2m

**Fuß- und Handbetätigung**  
Hand- and feet operations



**Nr. EQ-700**  
Code: OE438000438

**Pneumatik / Hydraulik-Einheit  
700 bar**

**Nr. EQ-300 014**  
Code: OE388000388

**Hydraulik-Handpumpe 700 bar**

**Nr. 300 015**  
Code: OE128000128

**Hydraulik-Schlauch 700 bar, 2m**



**Pneumatic-hydraulic unit 700 bar**

**Hydraulic pump 700 bar**

**Hydraulic hose 700 bar, 2m**

## DRUCK- UND ZUGHÜSENSATZ IM WERKSTATT-SERVICE WAGEN PRESS AND PULL SLEEVE KIT IN GARAGE SERVICE CART

### Werkstatt-Service Wagen mit Ablagefläche

Middle and bottom shelf to store parts



### Übersichtliche Anordnung

Ideal storage



**Universal Werkzeugsatz** zum Aus- und Einziehen von: Silentlagern, Hydrolagern, Buchsen, Kugellagern, Simmerringen, Gummilagern etc. Absolut universelle Anwendung. Ideal für unterschiedliche KFZ.

**Werkstatt-Service Wagen mit hoher Ablagefachlast.** Oberes Ablagefach bis max. 135 Kg belastbar. Mittleres und unteres Ablagefach bis max. 45 Kg belastbar. Stabile, kugelgelagerte und drehbare Leichtlauf-Rollen.

**Schaumstoffeinlage** zur idealen Aufbewahrung des Druck- und ZughüSENSATZES. Alle HüSENSATZES übersichtlich angeordnet und schnell griffbereit. Schaumstoffeinlage passend für alle 3 Ablagefächer des Werkstatt-Service Wagens.

**Nr. EQ-371**  
Code: OE64800648

**Druck- und ZughüSENSATZ im  
Werkstatt-Service Wagen**



**Universal tool set** for extracting and mounting: silent bearings, hydraulic bearings, bearing bushes, ball bearings, shaft seals, rubber bearings etc. Fully universal application. Ideal for different vehicles.

**Garage service cart with high load capacity.** Top shelf max. 135 Kg. Middle and bottom shelf max. 45 Kg. Turnable casters with ball bearings.

**Inlay for press and pull sleeve kit** for the ideal storage. All sleeves are clearly arranged and easy to find. Inlay fits for all three shelves of garage service cart.

**Press and pull sleeve kit in  
Garage service cart**



# BREMSE & RAD BRAKE & WHEEL



**MÜLLER Tipp:**  
elektronisches Dokument  
Artikelsuche mit "Strg + F"

**MUELLER Tip:**  
electronic document  
Product Search "Ctrl + F"

**Apple:** "⌘ + F"

## BREMSEN-HANDSCHLAGSCHRAUBER SET, 3/8" BRAKE SCREW IMPACT KIT, 3/8"



**Handschlagschrauber-Set** zum Lösen der oftmals sehr schwergängigen Sicherungsschraube der Bremsscheiben und Bremstrommeln. Durch den Schlag auf den Handschlagschrauber wird zum einen der Bit fest in den Schraubenkopf gepresst und durch die Drehbewegung gleichzeitig die Verschraubung ohne Beschädigung gelöst. Alle gängigen Verschraubungstypen im Satz enthalten. 5, 6 + 10mm Innensechskant, T 30, 40, 45 + 50. PZ3, PH 3 + 4

**Nr. 250 050 Handschlagschrauber Set, 3/8"**

Code: OE118000118



**Brake screw impact kit** for the easy and safe disassembling of brake disc & brake-drum screws. Due to the special construction the bit will be pushed into the screw + turns in one action. The kit includes 5, 6 + 10mm inner-hex, 30, 40, 45 + 50 T, PZ3, PH3 + 4.

**Nr. 250 050 Brake-screw impact kit, 3/8"**

Code: OE118000118



## GELENKKOPF-HEBELEISEN SWIVEL HEAD PRY BAR



**Universell einsetzbares Hebelwerkzeug.** Gelenk-Schwenkkopf in zahlreiche Positionen verstellbar. Schmales Profil ermöglicht den Einsatz der Hebeleisen an engen und schwer zugänglichen Stellen. Perfekte Einstellmöglichkeiten je nach Anforderung. Integrierter Ratschenmechanismus

**Nr. 276 500 Gelenkkopf-Hebeleisen-Satz, 3-tlg. 240, 320 + 390mm**

Code: OE112000112

**Nr. 276 513 Doppelgelenk-Hebeleisen 380mm**

Code: OE680000068



**Universal pry bar.** Swivel head is adjustable in many positions. Useable for tight and difficult reachable spots. Perfect tool for users.

**Swivel head pry bar kit, 3 pcs. 240, 320 + 390mm**

**Double-joint pry bar 380mm**

**10-fach Verstellmöglichkeit**  
10-positions available





## HARTMETALL SCHABER SATZ CARBIDE SCRAPER KIT



### Mueller's gasket; corrosion and carbon scraper

- Double edge blade
- Extremely durable due to high quality carbide inserts
- Works as pull or push tool
- Ergonomic hand grip
- Removes paint and glue in hard to reach areas
- Removes burned in corrosion on brakes
- Carbon on exhaust manifold etc...

### Carbide Scraper kit



- Für eingebrannte Beläge an Auspuff, Bremsen etc.
- Klingen mit 2 Schabkanten
- Arbeitet als Druck- und Zugklinge
- Ergonomischer Handgriff

### Nr. 268 220 Hartmetall Schaber Satz

Code: OE68000068

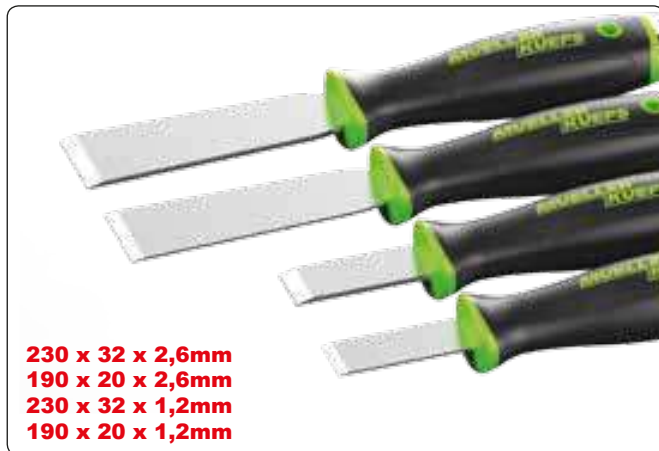

230 x 32 x 2,6mm  
190 x 20 x 2,6mm  
230 x 32 x 1,2mm  
190 x 20 x 1,2mm



### 2-Komponenten Kunststoffgriff

2-component handles

### Massive Schlagkappe

Hammer head



**Durchgehende, rostfreie Edelstahlklinge.** Nachschleifbar. 2-Komponenten-Kunststoffgriff. Massive, fest mit der Klinge verbundene Schlagkappe. 4-teiliger Satz bestehend aus je 2 Klingenstärken und 2 Längen.

### Nr. 268 400 Schabmeißel-Satz, 4-tlg.

Code: OE78000078

## SCHABMEIßEL-SATZ CHISEL SCRAPER KIT



**Stainless steel blade through handle,** easy to re-sharpen, 2-component handles, hammer head, 4pcs kit for 2 lengths + 2 thicknesses. Universal daily use.

### Chisel scraper kit, 4 pcs.

## KLEBEGEWICHT-ENTFERNER WHEEL WEIGHT REMOVER



**Ergonomisch geformtes Werkzeug** zum Entfernen der Klebgewichte z. B. bei Alufelgen. Verschiedene Handhabungen möglich. Auch für zweckfremde Arbeiten z.B. an Innenverkleidungen, Zierleisten etc. Klinge auf einer Seite teilweise gerundet zur Anwendung mit zwei Händen. Siehe Abbildungen.

**Nr. 282 230 Klebgewicht-Entferner**  
Code: OE880000880



**Ergonomic tool** that has many uses. Can be used for removing stick wheel weights or trim.

**Nr. 282 230 Wheel weight remover**  
Code: OE880000880

## KLEBEGEWICHTZANGE WHEEL WEIGHT PLIER

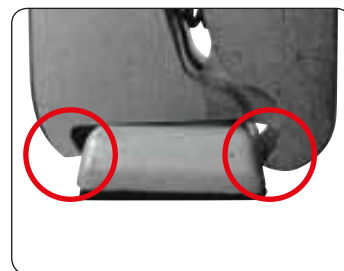

**Keine Beschädigung der Alufelge.**  
**Greift nur das Klebgewicht.**  
Does not touch rim. Grips weight only.



Zum beschädigungsfreien Entfernen der Auswucht-Klebgewichte an Alufelgen.

Die Präzisionszange greift die Klebgewichte nur seitlich und verhindert so jegliche Beschädigung der Felge.

Die Klebgewichte werden zur Seite "weggebrochen". Auch für hartnäckige, sehr festsitzende Gewichte.

Universell passend für nahezu alle Klebgewichte.

**Nr. 282 240 Klebgewichtzange**  
Code: OE680000068



- Specifically made to remove sticky wheel weights from aluminum rims.
- Thin edges grip the wheel weight without damaging the aluminum, leaving no scratches or notches in the metal.
- The pliers will never touch the wheel as the weights lean on their own tape.
- Features a spring-loaded handle.
- Rubber coated grip provides a comfortable handle.
- Wheel weights are fast and easy to remove.

**Nr. 282 240 Wheel Weight Plier**  
Code: OE680000068



**3-stufiger Leistungsregler**  
3-step power-control

## 1/2" XS SCHLAGSCHRAUBER, EXTRA KURZ 1/2" XS IMPACT WRENCH, ULTRA SHORT

WE SET THE STANDARD  
FOR **TORQUE!**

**Sehr niedrige Bauhöhe**  
Very low construction-height



**Ideal für sehr schwer erreichbare Arbeitspositionen**  
Made for hard to reach areas

**Sehr starke Leistung: max. 677Nm**  
High Power: max. 677Nm

**Stufenloser Abzug**  
Variable speed trigger

**Einhand-Umschalter**  
One hand switch

**Extra kurz, Extra stark!**  
**Ultra short, Extra strong!**

MÜLLER-WERKZEUG Technische Daten / technical information		1/4" MÜLLER 112	
		rechts	links
Max. Lösemoment / breakaway torque	Nm	615	677
Luftverbrauch / air consumption	l/min	134	134
Drehzahl / free speed	rpm	9.000 / 6.3 bar 10.500 / 8.0 bar	
Antrieb / drive	inch	1/2"	
Gewicht / weight	Kg	1.3	
Länge / length	mm	108	
Max. Arbeitsdruck / air pressure	bar	6.35	
Geräuschpegel / sound level	dBA	95	
Anschlussgewinde / air nipple	inch	1/4"	
Schlauch / air hose	mm	10	
Vibration / vibration level	m/s	9.60	



**Ultimative Power! Sehr starker Schlagschrauber mit neuartigem Design.** Ergonomisch perfekt angepasster Griff. Einhand-Umschalter kann auf Links- und Rechtshänder umgestellt werden. Geschwindigkeit + Rechts- und Links-Umstellung kann mit einer Hand bedient werden.

**Nr. EQ-294 112 1/2" XS Schlagschrauber, extra kurz**  
Code: OE148000148



**Very strong Impact Wrench with new design.** Ergonomic handle. Variable speed trigger. One hand switch. 3-speed control. Forward & reverse control can be switched to left or right handed. Aluminium / magnesium housing. Extremely powerful.

**1/2" XS Impact Wrench, Ultra Short**



**Schlagschrauber speziell für den Reifenwechsel.** Volle Leistung von 1600Nm zum Lösen. Reduzierte Leistung im Rechtslauf mit maximalem Anzugsmoment ca. 80Nm bei 8,0bar. Mit diesem Müller Schlagschrauber können die Rad-schrauben nach Werksvorschrift vormontiert und mit dem Drehmomentschlüssel nachgezogen werden.

**Nr. EQ-294 114/80er 1/2" Müller Schlag-schrauber, 80Nm/8bar**  
Code: OE228000228



**Impact gun specially engineered for the wheel change.** Full power of 1600Nm in reverse. Reduced power for torque on with a max of roughly 80Nm at 8,0bar. This Mueller impact gun ensures a wheel bolt pre-mounting and a final fixing with the torque wrench as requested from car manufacturer.

**Nr. EQ-294 114/80er 1/2" Mueller impact gun, 80Nm/8bar**  
Code: OE228000228



**Mit Begrenzung im Rechtslauf**  
Torque on restricted

**Losbrechmoment 1600Nm**  
Breakaway torque 1600Nm

## MÜLLER-SCHLAGSCHRAUBER IMPACT WRENCH



3-step power control

**3-stufiger Leistungsregler**  
3-step power-control

**Aluminium/Magnesium Schlagwerk-Gehäuse**  
housing

**Doppelhammer-Schlagwerk**  
Twin-Hammer

**stufenloser Abzug**  
variable speed trigger

**echte Einhand-Bedienung**  
one handed operation

**ergonomischer Griff**  
ergonomic handle

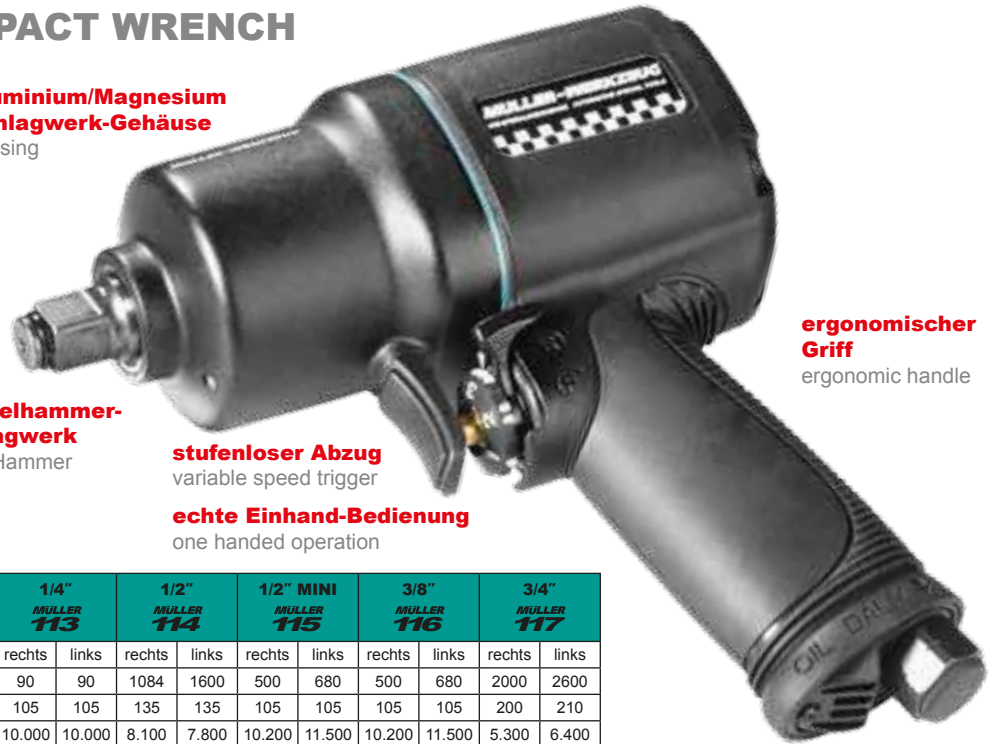

**DER MAßSTAB FÜR KRAFT!**

MÜLLER-WERKZEUG Technische Daten / technical information	1/4" MÜLLER 113		1/2" MÜLLER 114		1/2" MINI MÜLLER 115		3/8" MÜLLER 116		3/4" MÜLLER 117		
	rechts	links	rechts	links	rechts	links	rechts	links	rechts	links	
Max. Lösemoment / breakaway torque	Nm	90	90	1084	1600	500	680	500	680	2000	2600
Luftverbrauch / air consumption	l/min	105	105	135	135	105	105	105	105	200	210
Drehzahl / free speed	rpm	10.000	10.000	8.100	7.800	10.200	11.500	10.200	11.500	5.300	6.400
Antrieb / drive	inch	1/4"		1/2"		1/2"		3/8"		3/4"	
Gewicht / weight	Kg	0.90		1.80		1.08		1.08		3.20	
Länge / length	mm	118		174		146		146		215	
Max. Arbeitsdruck / air pressure	bar	6,2		6,2		6,2		6,2		6,2	
Geräuschpegel / sound level	dBA	98.2		94.2		93.5		93.5		105.1	
Anschlussgewinde / air nipple	inch	1/4"		1/4"		1/4"		1/4"		3/8"	
Schlauch / air hose	mm	9-13		9-13		9-13		9-13		9-13	
Vibration / vibration level	m/s	2.96		2.96		7.50		4.80		6.50	

**WE SET THE STANDARD FOR TORQUE!**



**Ultimative Power! Sehr starker Schlagschrauber mit neuartigem Design.** Ergonomisch perfekt angepasster Griff. Einhand-Umschalter kann auf Links- und Rechtshänder umgestellt werden. Geschwindigkeit + Rechts- und Links-Umstellung kann mit einer Hand bedient werden.



**Very strong Impact Wrench with new design.** Ergonomic handle. Variable speed trigger. One hand switch. 3-speed control. Forward & reverse control can be switched to left or right handed. Aluminium/ magnesium housing. High powerful twin-hammer.

**Ausführungen / models:**



**Nr. 294 113 1/4" Schlagschrauber, max. 90 Nm**

Code: OE158000158

**1/4" Impact Wrench, max. 90Nm**

**Nr. 294 114 1/2" Schlagschrauber, max. 1600 Nm**

Code: OE228000228

**1/2" Impact Wrench, max. 1600Nm**

**Nr. 294 115 1/2" MINI-Schlagschrauber, max. 680 Nm**

Code: OE218000218

**1/2" MINI-Impact Wrench, max. 680Nm**

**Nr. 294 116 3/8" MINI-Schlagschrauber, max. 680 Nm**

Code: OE248000248

**3/8" MINI-Impact Wrench, max. 680Nm**

**Nr. 294 117 3/4" Schlagschrauber, max. 2600 Nm**

Code: OE668000668

**3/4" Impact Wrench, max. 2600Nm**

3 Bremse & Rad Brake & Wheel

4 Motor Engine-Tools

5 Zerspanung Cutting Tools

6 Karosserie/Verschleiß AutoBody/Consumables

7 Universal-Werkzeuge Universal Tools

8 Transporter & LKW Heavy Duty & Trucks

9 Equipment

Inhaltsverzeichnis Table of Contents

## SCHUTZHÜLLEN FÜR MÜLLER- SCHLAGSCHRAUBER PROTECTIVE COVERS FOR MUELLER IMPACT WRENCHES



Hochbelastbar, abriebfest,  
schützen das Gerät zuverlässig.  
Heavy-duty, abrasion resistant,  
reliably protects the tool.

Schutzhülle für / Protective cover for

Nr. 294 114/SH Müller 114 1/2"

Code: OE180000018

Nr. 294 115/SH Müller 115 1/2" Mini + 3/8"

Code: OE180000018

Nr. 294 117/SH Müller 117 3/4"

Code: OE280000028

## FELGEN-RADIERSCHEIBE CONICAL ERASER FOR RIMS

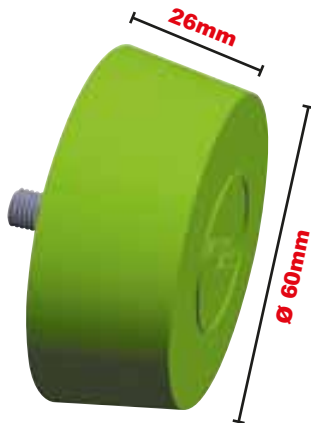

Konische Raderscheibe zum Entfernen der Kleberück-  
stände von Auswuchtgewichten.  
Zur Verwendung mit Stabradierer Nr. 297 010 etc..

**Nr. 282 260 Felgen-Raderscheibe**

Code: OE980000980



Conical eraser disc to remove the adhesives of wheel  
weights. For use with air eraser no. 297 010.

**Nr. 282 260 Conical eraser for rims**

Code: OE980000980

## STABRADIERER FÜR KLEBEGEWICHTE ERASER FOR SELF- ADHESIVE WEIGHTS



Speziell zur Verwendung mit  
diesen Scheiben abgestimmter  
Getriebe-Druckluftschleifer mit 1  
PS Leistung. Hervorragend zur  
Entfernung von Aufklebern, Zier-  
streifen, TÜV-Plaketten, Farb-  
spritzern auf Lacken. Verwendung  
von Schabern oder Heißluftföhn  
entfällt. Ø 100 x 15 mm. Lieferung  
mit 1 Stk. Raderscheibe.

**Nr. 297 010 Stabradierer**

Code: OE128000128

komplett mit 1  
Raderscheibe  
Ø 100mm

Nr. 297 011

Code: OE140000014

Raderscheibe  
Ø 100mm einzeln

Nr. 297 111

Code: OE133000133

Raderscheiben  
Ø 100mm 10 Stk.  
+ 1 Adapter für  
Bohrmaschine



Especially for use with discs  
designed for air grinders with  
1 HP power. Excellent for re-  
moving stickers, decorative  
strips, splashes of color on  
paint. No longer necessary to  
use scrapers or heat gun. Ø  
100 x 15 mm. Supplied with 1  
erasing disc

**Air Eraser** complete with 1  
erasing disc Ø 100mm

Erasing disc  
Ø 100mm separate

Erasing discs Ø 100mm  
10 pcs. + 1 adaptor for drills

## ADAPTER



**Nr. 297 013 Adapter für Bohrfutter**

Code: OE780000780

passend für Nr. 297 011 + Nr. 282 260



**Nr. 297 013 Adapter for Drill-Chuck**

Code: OE780000780

fits for no. 297 011 + no. 282 260



**TOOL-INNOVATION**  
1997

Alle Teile auch einzeln erhältlich.  
All parts separately available.

Hülse 1 / Lug nut 1	Ø 18mm,	Nr. 432 801
Hülse 2 / Lug nut 1	Ø 20mm,	Nr. 432 802
Hülse 3 / Lug nut 1	Ø 22mm,	Nr. 432 803
Hülse 4 / Lug nut 1	Ø 24mm,	Nr. 432 804
Hülse 5 / Lug nut 1	Ø 26mm,	Nr. 432 805
Aufschlag-Prellwerkzeug / Setter for lug nut remover		Nr. 432 816
Austreiber / Pin punch	180x22x12,	Nr. 432 822



**Verwendbar für nahezu alle aktuellen Radsicherungs-Systeme.** Kein Bohren oder Meißeln erforderlich. Kein Beschädigen der Felgen möglich. Kein Zerstören der Rad-sicherung. Öffnungszeit pro Rad ca. 30 Sekunden!

**Nr. 432 800 Radschloss-Lösewerkzeug**  
Code: OE153000153

**RADSCHLOSS-LÖSEWERKZEUG**  
LUG NUT REMOVER KIT

Hülsen Ø: 18, 20, 22, 24, 26mm  
Lug nut Ø: 18, 20, 22, 24, 26mm



**Austreiber**  
Pin punch

**Aufschlag-Prellwerkzeug**  
Setter for lug nut remover



**Can be used for nearly all lug nut systems.** No drilling, no work with chisels. No damaging of the aluminium wheels. No destroy of the lug nuts. Needed time for one wheel 30 seconds!

**Lug nut remover kit**



**RADNABENSCHLEIFER TYP 1, Ø 60mm innen**  
WHEEL HUB GRINDER TYPE 1, Ø 60mm internal



**Schleif- Ø 160mm**  
Grinding Ø 160mm

**Drehzahl max. 1500 U/min**  
Max. speed 1500 rpm

**Naben Ø max 60mm**  
Hub Ø max 60mm



**Lieferumfang Nr. 433 502:**  
**1 Grundgerät + 3 Scheiben**  
Shipment no. 433 502: 1 basic unit + 3 discs



**Spezialschleifer zur Reinigung der Radzentrierung** und der Anlagefläche RAD zur NABE. Festgebrannte Korrosionsrückstände werden schnell, unkompliziert und restlos entfernt. Effektive Bearbeitungszeit je Nabe 3 - 25 Sekunden.

**Nr. 433 502 Radnabenschleifer Typ 1, Ø 60mm innen**  
Code: OE820000082

Nr. 433 501  
Code: OE640000064

Ersatzscheiben, VPE 3 Stk. für RNS Typ 1



**Special grinder for cleaning the wheel centring device** and the attachment face between WHEEL and HUB. Stubborn corrosion residues are removed quickly, easily and completely. Actual processing time per hub 3 - 25 seconds.

**Wheel hub grinder type 1, Ø 60mm internal**

Spare discs, 3 pcs.

## RADNABENSCHLEIFER TYP 1, 1/2" Antrieb, Ø 75mm innen WHEEL HUB GRINDER TYPE 1, 1/2" drive, Ø 75mm internal



**Einsatz in Verbindung mit 1/2" Antrieb wie z. B. Druckluft-Schlagschrauber/-Knarre, Akku-Schlagschrauber**

- Auswechselbare Reinigungsscheibe
- Extrem lange Standzeit von bis zu 100 Fahrzeugen
- Perfektes Finish - kein Funkenflug
- Minimale Staubentwicklung im Gegensatz zu Drahtbürsten etc. durch offenesporiges Schleifmittel und topfförmigen Schleifteller.
- Ergebnis: Kontaktfläche ist nicht mehr durch Rückstände verunreinigt, Anzugsdrehmomente können nicht mehr verfälscht werden.



1/2"



**Drehzahl max. 500 U/min**  
Max. speed 500 rpm

**Schleif- Ø 160mm**  
Grinding Ø 160mm



**Lieferumfang Nr. 433 500: 1 Grundgerät + 1 Scheibe**  
Shipment no. 433 500: 1 basic unit + 1 disc



**Spezialschleifer zur Reinigung der Radzentrierung** und der Anlagefläche RAD zur NABE. Festgebrannte Korrosionsrückstände werden schnell, unkompliziert und restlos entfernt. Effektive Bearbeitungszeit je Nabe 3 - 25 Sekunden. Ideale Ergebnisse bei möglichst langsamer Drehzahl.

**Nr. 433 500 Radnabenschleifer Typ 1, 1/2" Antrieb, Ø 75mm innen**  
Code: OE59000059

Nr. 433 503  
Code: OE78000078

Ersatzscheiben,  
VPE 3 Stk. für RNS Typ 1, 1/2"



**Special grinder for cleaning the wheel centering device** and the attachment face between WHEEL and HUB. Stubborn corrosion residues are removed quickly, easily and completely. Actual processing time per hub 3 - 25 seconds. Works best at lowest rpm.

**Wheel hub grinder type 1, 1/2" drive, Ø 75mm internal**

Spare discs, 3 pcs.

**RADNABENSCHLEIFER TYP 1, Ø 75 mm innen**  
**WHEEL HUB GRINDER TYPE 1, Ø 75 mm internal**



**Schleif- Ø 160mm**  
Grinding Ø 160mm  
**Drehzahl max. 1500 U/min**  
Max. speed 1500 rpm



**Mit größerem Innendurchmesser (75mm) für Fahrzeuge wie z.B. BMW.**

With larger internal diameter (75mm) for vehicles, e.g. BMW.



**Lieferumfang Nr. 433 504:**  
**1 Grundgerät + 3 Scheiben**

Shipment no. 433 504: 1 basic unit + 3 discs



**Spezialschleifer zur Reinigung der Radzentrierung** und der Anlagefläche RAD zur NABE. Festgebrannte Korrosionsrückstände werden schnell, unkompliziert und restlos entfernt. Effektive Bearbeitungszeit je Nabe 3 - 25 Sekunden.

**Nr. 433 504 Radnabenschleifer Typ 1, Ø 75mm innen**

Code: OE82000082

Nr. 433 505  
Code: OE64000064

Ersatzscheiben für Radnabenschleifer Typ1 Ø 75mm innen, VPE 3 Stk.  
Auch passend für Grundgerät Nr. 433 502.



**Special grinder for cleaning the wheel centring device** and the attachment face between WHEEL and HUB. Stubborn corrosion residues are removed quickly, easily and completely. Actual processing time per hub 3 - 25 seconds.

**Wheel hub grinder type 1, Ø 75mm internal**

Spare discs for wheel hub grinder 1, Ø 75mm internal, 3 pcs. Also fit for basic unit no. 433 502.

3  
Brems- & Rad  
Brake & Wheel

4  
Motor  
Engine-Tools

5  
Zerspanung  
Cutting Tools

6  
Karosserie/Verschleiß  
AutoBody/Consumables

7  
Universal-Werkzeuge  
Universal Tools

8  
Transporter & LKW  
Heavy Duty & Trucks

9  
Equipment

Inhaltsverzeichnis  
Table of Contents



# FELGENFLANSCH-REINIGER INNER RIM CLEANER

TOOL-INNOVATION  
2017



WATCH THE VIDEO HERE



zur  
**Verwendung vor dem  
Auswuchten**  
to use before balancing

**Lieferumfang Nr. 433 507:**  
**1 Grundgerät + 1 Scheibe**

Shipment no. 433 507:  
1 basic unit + 1 disc



**The Mueller Kueps Inner Rim Cleaner is meant for the optimal cleaning of the inner wheel contact surface.** It prevents corrosion related distortion of wheel bolt tightening torque and allows you to completely remove burnt in corrosion. To be used only on the inside of an aluminum rim, particularly the inner area prior to wheel balancing. Due to the porous abrasives and a cup shaped grinding plate there is minimal dust and the Velcro adhesive makes it easy to change out. It has been optimized for the latest wheel rims with an enlarged diameter of 75mm.

## Inner Rim Cleaner

Spare discs for inner rim cleaner,  
3 pcs.  
Also fit for basic unit  
no. 433 502.



**Speziialschleifer zur Reinigung der Anlagefläche an der Felgen-Innenseite.** Feste Korrosionsrückstände werden schnell, unkompliziert und restlos entfernt. Bearbeitungszeit je Felge 3-25 Sekunden.

## Nr. 433 507 Felgenflansch-Reiniger

Code: OE58000058

Nr. 433 508  
Code: OE780000078

Ersatzscheiben für Felgenflansch-Reiniger  
VPE 3 Stk.  
Auch passend für Grundgerät Nr. 433 502  
und 433 504.

## ALU-RADNABENSCHLEIFER TYP 2 ALUMINIUM-WHEEL HUB GRINDER TYPE 2



**TOOL-INNOVATION**  
2011



**Spezierschleifer zur Reinigung der Felgenanlagefläche** für Fahrzeuge mit Stehbolzen. Rost an der Radnabe wird schnell und unkompliziert entfernt.

### Nr. 433 610 Alu-Radnabenschleifer Typ 2

Code: OE760000076

Nr. 433 640 Ersatzscheiben klein, VPE 5 Stk.

Code: OE240000024

Nr. 433 650 Ersatzscheiben groß, VPE 5 Stk.

Code: OE250000025



**Special grinder for the cleaning of the wheels rim contact surface.** For vehicles with stud bolts. Corrosion are removed quickly and easily.

### Nr. 433 610 Aluminium-Wheel hub grinder type 2

Code: OE760000076

Nr. 433 640 Spare discs small, 5 pcs.

Code: OE240000024

Nr. 433 650 Spare discs large, 5 pcs.

Code: OE250000025



**Lieferumfang:**  
1 Grundgerät + 5 Scheiben Ø 40mm  
+ 6 Scheiben Ø 50mm

Shipment:  
1 basic unit + 5 discs Ø 40mm  
+ 6 discs Ø 50mm



## DRUCKLUFT-BOHRMASCHINE AIR DRILL

**2-komponenten Kunststoffgehäuse**  
2 - component housing



**Stufenloser Abzug**  
Variable speed

**Ergonomischer Griff**  
Ergonomic handle

**Leistungs- und drehmomentstark**  
**speziell für Radnabenschleifer**

Power and high torque especially for hub grinder

**500 U/min / rpm**



**Industrie-Druckluftbohrmaschine** mit 2-Komponenten Kunststoffgehäuse. Abluftgeräusch gedämmt nach unten, verstellbarer zusätzlicher Handgriff, Rechts-Links Umschaltung mit einer Hand.



**Cool insulated** based on 2-component housing. Soft handle. Exhaust downside, left / right switch. Could be used for grinding and drilling.

### Nr. 290 432 Druckluft-Bohrmaschine 500 U/min

Code: OE248000248

### Air drill 500 rpm

<b>MÜLLER-WERKZEUG</b> Technische Daten / technical information		
Bohrfutter / drive	Zoll	1/2"
Gewicht / weight	Kg	1,75
Länge / length	mm	230
Anschlussgewinde / air nipple	Zoll	1/4"
Schlauchanschluss / air hose	mm	9-13
Luftverbrauch / air consumption	l/min	200
Drehzahl/min / rpm	Rpm	500
Arbeitsdruck / air pressure	bar	6,2
Geräuschpegel / sound level	dBA	80

## 8-KANT-ALU-RADNABENSCHLEIFER TYP 2 8-POINT-ALU-WHEEL HUB GRINDER TYPE 2

 **PATENTIERT**

**TOOL-INNOVATION**  
2012



Ø 50mm

Ø 40mm

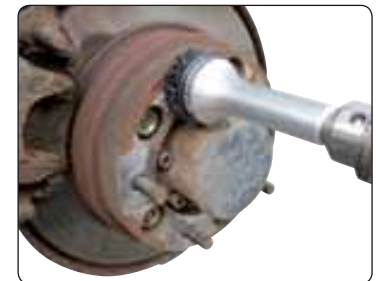

**Spezierschleifer zur Reinigung der Felgenanlagefläche** für Fahrzeuge mit Stehbolzen. Rost an der Radnabe wird schnell und unkompliziert entfernt.

**Nr. 433 618 8-kant-Alu-Radnabenschleifer Typ 2**  
Code: OE760000076

**Nr. 433 618/M 8-kant Alu-Radnabenschleifer Typ 2**, 1 Halter + 2 Scheiben groß, 3 Scheiben klein

Nr. 433 648 8-kant-Ersatzscheiben klein, VPE 5 Stk.

Nr. 433 658 8-kant-Ersatzscheiben groß, VPE 5 Stk.



**Special grinder used to clean the wheel rim contact surface**, designed for vehicles with stud bolts. Corrosion is quickly and easily removed.

**8-point-Alu-Wheel hub grinder type 2**

**8-point-Alu-Wheel hub grinder type 2**, 1 holder + 2 discs large, 3 discs small

8-point-spare discs small, 5 pcs.

8-point-spare discs large, 5 pcs.

## RADNABENSCHLEIFER TYP 3 WHEEL HUB GRINDER TYPE 3



**Schleif- Ø 200mm**  
Grinding Ø 200mm



**Naben Ø max 90mm**  
Hub Ø max 90mm



**Drehzahl max. 1000 U/min**  
Max. speed 1000 rpm



**Lieferumfang Nr. 433 700:**  
**1 Grundgerät + 2 Scheiben**  
Shipment no. 433 700: 1 basic unit + 2 discs



**Spezialschleifer zur Reinigung der Radzentrierung** und der Anlagefläche RAD zur NABE. Festgebrannte Korrosionsrückstände werden schnell, unkompliziert und restlos entfernt. Effektive Bearbeitungszeit je Nabe 3 - 25 Sekunden.

**Nr. 433 700 Radnabenschleifer Typ 3**

Code: OE960000096

Nr. 433 720  
Code: OE640000064

Ersatzscheiben, VPE 2 Stk.



**Special grinder for cleaning the wheel centring device** and the attachment face between WHEEL and HUB. Stubborn corrosion residues are removed quickly, easily and completely. Actual processing time per hub 3 - 25 seconds.

**Wheel hub grinder type 3**

Spare discs, 2 pcs.

## 8-KANT LKW-RADNABENSCHLEIFER TYP 4 8-POINT WHEEL HUB GRINDER TYPE 4



**TOOL-INNOVATION  
2013**



**Spezierschleifer zur Reinigung der Felgenanlagefläche** für LKW und Transporter mit Stehbolzen. Rost an der Radnabe wird schnell und unkompliziert entfernt.

**Nr. 433 918 8-kant LKW-Radnabenschleifer Typ 4**

Code: OE112000112

Nr. 433 958 8-kant Ersatzscheiben Typ 4, VPE 5 Stk.

Code: OE290000029

Nr. 433 958/PUR 8-kant Ersatzscheiben grob, VPE 5 Stk.

Code: OE390000039



### Lieferumfang:

**1 Grundgerät mit Scheibe + je 5 Scheiben**

Shipment: 1 basic unit with disc and 5 discs each



**Special grinder used to clean the wheel rim contact surface**, for trucks and vans with studs. Corrosion is quickly and easily removed.

**Nr. 433 918 8-point wheel hub grinder type 4**

Code: OE112000112

Nr. 433 958 8-point spare discs, 5 pcs.

Code: OE290000029

Nr. 433 958/PUR 8-point spare discs rough, 5 pcs.

Code: OE390000039



8-kant  
8-point



## VENTILDREHER - SELBSTKLEMMEND VALVE CORE TOOL

**Universal**



**Nr. 437 001**



**Nr. 437 001/4**



- hörbares Einrasten
- hält den Ventilkern sicher fest
- einfache Handhabung
- spart Zeit und Geld

**Nr. 437 001 Ventildreher selbstklemmend**

Code: OE980000980

**Nr. 437 001/4 Ventildreher selbstklemmend, Satz 4-tlg.**

Code: OE380000038



- Insert the Tool into the valve stem.
- Tool will "click" when properly connected to core.
- Upon removing the core, tool will retain the core.
- Easily and quickly replace the core.
- For one handed operation.

**Valve Core Tool with valve core holder**

**Valve Core Tool with valve core holder, Kit 4pcs.**

## BREMSFEDERWERKZEUG BRAKE SPRING TOOL



**Zur Montage und Demontage von Bremsfedern**

For demounting and installing the brake springs



**Bewährtes Spezialwerkzeug** zur De- und Montage der Justierfeder bei Trommelbremsen. Universell einsetzbar z. B. VAG, Fiat, Ford.

**Nr. 455 001 Bremsfederwerkzeug**

Code: OE21000021



**Usefull tool** for demounting and installing the spring at drum brakes. Universal use at VAG, Fiat, Peugeot and others.

**Brake spring tool**

## MÜLLER PRÄZISIONS MONTAGEHÜSEN SATZ MUELLER-MOUNTING SLEEVE KIT



**Präzisions-Hülse justiert die 2 Innenringe**

Sleeve centers the 2 race rings

**schnell & sicher!**



**Zur Montage der neuartigen Bremsscheiben & Brems-trommeln mit integrierten Radlagern.** Ohne Montagehülsen verkanten sich diese auf dem Achszapfen. Beim Versuch, die Trommel oder Scheibe vom Achszapfen zu ziehen, zerlegen sich die Radlager irreparabel. Mit dem Müller Präzisions Montagehülsen Satz wird das Verkanten sicher vermieden. Passende Hülse in das integrierte Lager einschieben, dadurch sind die zwei Lagerinnenringe vorjustiert. Nun die Bremstrommelscheibe mit der Hülse über den Gewindestumpf des Achszapfens (dünn ölen) auf die Passung schieben. Funktioniert ohne Hammer etc. bis zum Anschlag.

- keine Beschädigung der integrierten Radlager
- schnell + sicher
- 8 verschiedene Größen für alle aktuellen Fahrzeuge mit diesen Bremsen

**Nr. 455 080 Müller Präzisions Montagehülsen Satz, 8-tlg.**

Code: OE128000128



**Mounting-sleeves for the new brake-disc / brake-drum with integrated wheel bearing.** This tool has been developed to support the mounting job of the brake-disc/drum with integrated wheel bearings. The sleeve will adjust the two inner race rings of the integrated wheel bearing. No damage by installing. No more mounting-cants by installing of the disc/drum on the axle-shank.

- no destroy on the integrated bearing
- Save, fast & professional
- 8 different sleeves fit for all cars

**Mounting-sleeve kit, 8 pcs.**





## BREMSSCHEIBEN SCHIEBLEHRE DIGITAL BRAKE DISC CALIPER DIGITAL



Profiausführung, bequemes und sicheres Ablesen des Messwertes. Messwert kann dem Kunden gezeigt werden. Messschenkel ermöglichen das exakte Messen trotz Grat an der Bremsscheibe.

**Nr. 456 010 Bremsscheiben Schieblehre digital**  
Code: OE78000078

**Nr. 456 011 Bremsscheiben Schieblehre digital mit deutschem Kalibrierzertifikat**



Convenient reading of measurements. Measuring jaw design permits accurate measurement even if a brake disc has a burr. Professional design fits for workshop use.

**Brake Disc Caliper Digital**

**Brake Disc Caliper Digital with German Certificate**





**Für z. B. BOSCH + ATE-Sensoren bis 10mm**

Fits e. g. BOSCH + ATE-sensors up to 10mm



**Führungsstück ausbohren und Reststück nach unten rausziehen**

Drill out the guide piece, extract the oddment down

## ABS-SENSOR-SATZ ABS-SENSOR-KIT

**Durch integrierte, feinstverzahnte Spezialnarre nur Rechtsdrehung möglich**

Clockwise rotation based on the integrated ratchet wrench



**Satz zum Ausbohren der defekten ABS-Sensoren** und zum Reiben von Führungsbohrungen der ABS Sensoren bis 10mm. Passend z. B. für FORD, MERCEDES, VW, SEAT, AUDI, SKODA, etc. DBGM

**Nr. 456 110 ABS-Sensor-Satz**

Code: OE144000144



**Kit for drilling out the damaged ABS-Sensors** and reaming the precision hole for sensor up to 10mm. Fits for FORD, MERCEDES, VW-group cars as SEAT, SKODA, AUDI.

**ABS-Sensor kit**



**Nr. 456 121 ABS-Reibahle VW Golf 6**  
ABS-reamer VW Golf 6



**Zur Reinigung der Führungsbohrung** des ABS-Sensors im Radlagergehäuse von Rost, Schmutz, Korrosion etc. Bei Anwendung des Werkzeuges keine Beschädigung des Neuteiles durch unsachgemäßes Einschlagen, Einpressen etc. Gewährleistung exakter Messwerte durch sauberen und korrekten Sitz des neuen Sensors. Durch integrierte, abgewinkelte, feinstverzahnte Spezialnarre nur Rechtsdrehung möglich. DBGM

**Nr. 456 121 ABS-Reibahle Ø11mm**  
Code: OE108000108

**Nr. 456 150 ABS-Reibahle Ø15x23mm**  
Code: OE92000092

**Nr. 456 180 ABS-Reibahle Ø18x23mm VAG**  
Code: OE86000086

**Nr. 456 181 ABS-Reibahle Ø18x34mm AUDI A4/A6**  
Code: OE965009650

**Nr. 456 184 ABS-Reibahle Ø18x45mm LKW**  
Code: OE118000118

## REIBAHLE FÜR ABS-SENSOR REAMER FOR ABS-SENSOR



**Nr. 456 184 ABS-Reibahle für LKW Ø18x45mm**  
ABS-reamer heavy duty Ø 18x45mm



**To clean rust and oxidation** of the ABS-Sensor hole at the wheelbearing housing. This tool avoids that ABS-Sensors will break at installing process. Ensures exact measuring results, based on perfect fitting sensor seat. Integrated ratchet wrench. Pat.

**ABS-reamer Ø11mm**

**ABS-reamer Ø15x23mm**

**ABS-reamer Ø18x23mm VAG**

**ABS-reamer Ø18x34mm AUDI A4/A6**

**ABS-reamer Ø18x45mm**



**Nr. 456 180 ABS-Reibahle VAG Ø18x23mm**  
ABS-reamer VAG Ø 18x23mm



**Nr. 456 181 ABS-Reibahle AUDI A4/A6 Ø18x34mm**  
ABS-reamer AUDI A4/A6 Ø 18x34mm





## GEWINDE-REPARATURSATZ M9X1,25 THREAD REPAIR SET M9X1,25

**Gewindebohrer M9x1,25**  
Tap M9x1,25

**Gewindebüchsen M9x1,25 mit Kupferring**  
Thread inserts M9x1,25 incl. copper rings

**Bohrschablone**  
Drill guide

**Spezialaufbohrer, TIN-beschichtet**  
Special drill, TIN coated



**Werkzeug, um defekte Innengewinde für Bremsen-Führungsbolzen in Radlagergehäusen zu reparieren.** Das im Radlager-Gehäuse angebrachte Innengewinde M9 x 1,25 dient zur Verschraubung der Bremsen-Führungsbolzen.

**Nr. 456 200 Gewinde-Rep.Satz M9x1,25 VAG**

Code: OE152501525

**Nr. 456 230 Gewinde Rep.Satz M9x1,25 OPEL**

Code: OE152501525

**Nr. 456 240 Gewinde Rep.Satz M9x1,25 FORD**

Code: OE152501525

Nr. 456 210

Code: OE68000068

Ersatzbüchsen + Kupferringe VPE 10 Stk.



**Tool to repair the defective internal threads of brake guide pins** in wheel bearing housings. The M9 x 1.25 internal thread in the wheel bearing housing is provided for screwing in the brake guide pins.

**Thread repair set M9x1,25 VAG**

**Thread repair set M9x1,25 OPEL**

**Thread repair set M9x1,25 FORD**

Thread inserts + copper rings 10pcs

## UNIVERSAL BREMSENSATZ BRAKE HEX BIT KIT

**Länge: 45mm**

Length: 45mm



6mm

7mm

8mm

9mm

11mm



**Universelle Anwendung** an schwer zugänglichen Stellen. Die oftmals schwer zugängliche Innensechskant Feststellschraube der Bremssattel kann schnell & einfach gelöst werden. Der schwenkbare Ringratschenschlüssel kann in der Winkelposition so eingestellt werden, dass die Innensechskantnüsse ideal angesetzt werden können. Für Innensechskantschrauben 6, 7, 8, 9, 11mm.

**Nr. 456 550/6 Bremsen-Innen-6-kant Satz**

Code: OE68000068



**Universal use** on narrow space areas. The hard to reach hex bolt of the brake caliper can be screwed easily based on the turnable ratchet wrench. The kit includes 6, 7, 8, 9, 11mm hex bits.

**Brake hex bit kit**



## TOOL-INNOVATION 2013

**klein & handlich**

**Ringratschenschlüssel kann in der Winkelposition so eingestellt werden, dass ein Arbeiten an sehr schwer zugänglichen Stellen möglich ist. Z. B. VW/AUDI, Bremssattel Hinterachse.**

The hard to reach bolts of brake caliper can be screwed thanks to the turnable ratchet wrench. Example of use: VW / AUDI, rear brake caliper.

**BREMSSATTEL DICHTSITZREINIGER VAG + OPEL**  
**SEAL SEAT REAMER FOR VAG + OPEL**



**Dichtsitzreiniger für Hinterachsattel** z. B. Lukas-Bremssattel VW Golf 4, Audi A3, Bora, Polo, Seat Leon, Skoda Oktavia, etc. Durch Erneuerung des Dichtsitzes keine Undichtigkeit im Bereich des Bremsleitungsanschlusses.

**Nr. 456 300 Bremssattel-Dichtsitzreiniger VAG**

Code: OE980000098

**Nr. 456 310 Bremssattel-Dichtsitzreiniger OPEL**

Code: OE980000098

**TOOL-INNOVATION**  
2006



**Führungspilot für Fräser**  
Pilot tool for reamer

**M16mm, Nr. 456 310**  
**M18mm, Nr. 456 300**



**Seal seat reamer kit.** Brake line connection to lukas brake caliper is leaking. Reason for that is oxidation of aluminium seal seat. This happens especially at VW Golf 4, Audi A3, Bora, Polo, Seat Leon, Skoda Oktavia etc.

**Nr. 456 300 Seal seat reamer for VAG**

Code: OE980000098

**Nr. 456 310 Seal seat reamer for OPEL**

Code: OE980000098

**LEITUNGSSCHLÜSSEL-SATZ**  
**LINE WRENCH KIT**



**Zur verbesserten Kraftübertragung** und für exakten Drehmomentanzug nach Vorschrift für Verschraubungen z.B. an Bremsleitungen, Klimaanlage etc. SW 10, 11, 12, 13 und 14 mm in jeweils kurzer und langer Ausführung auch für vertieft liegende Verschraubungen. 12-kant Ringschlüssel zum kurzen Nachfassen bei beengten Verhältnissen und Spezial-Stecknuss SW 22 x 3/8" zum Ansetzen des Drehmomentschlüssels axial zum Schraubenmittelpunkt.

**Nr. 457 100 Leitungsschlüssel-Satz**

Code: OE149000149



**For improved and exact torque transfer** as on brakes and air conditon. 10, 11, 12, 13, 14mm always long an short type. Long type for deep and narrow spaces. 12-point open spanner for narrow spaces. Special socket for use with torque wrench.

**Nr. 457 100 Line wrench kit**

Code: OE149000149



**BREMSEITUNGS-SCHLÜSSELSATZ**  
**BRAKE LINE WRENCH KIT**



**Kräftig ausgeführte, offene Ringschlüssel.** Werkstattsatz mit allen gängigen Zoll- und Metrischen Größen. Spiegelpoliert, keine scharfen Kanten. Lieferung komplett in Tasche.

**Nr. 457 600 Bremsleitungs-Schlüsselsatz, 6-tlg.**

Code: OE580000058



**Extra high durability.** Opened rings for professional shop use. Mirror finish. Includes most used sizes. Shipment with pouch bag.

**Nr. 457 600 Brake line wrench kit, 6 pcs.**

Code: OE580000058



**7/16 + 3/8",**  
**9/16 + 1/2"**

**8 + 10mm, 10 + 11mm,**  
**11 + 13mm, 12 + 14mm**

**Alle Schlüssel einzeln erhältlich (siehe Preisliste).**  
All parts separately available (see price list).

3  
Bremse & Rad  
Brake & Wheel

4  
Motor  
Engine-Tools

5  
Zerspanung  
Cutting Tools

6  
Karosserie/Verschleiß  
AutoBody/Consumables

7  
Universal-Werkzeuge  
Universal Tools

8  
Transporter & LKW  
Heavy Duty & Trucks

9  
Equipment

Inhaltsverzeichnis  
Table of Contents

## ENTLÜFTERSCHLÜSSELSATZ BRAKE BLEEDER WRENCH SET



**Entlüfterschlüsselsatz zum Öffnen und Schließen der Entlüftungsventile.** Die Ringschlüsselseite ist als 6-Kant und um 10° abgewinkelt. Dadurch keine Beschädigung der Entlüftungsventile.

Größen: SW 7, 8, 9, 11, 12, 14 mm

**Nr. 458 600 Entlüfterschlüsselsatz**

Code: OE49000049



**Bleeder wrench set for opening and closing the bleed valves.** The ring-ends of the wrenches are hexagonal and angled to 10°. As a result, no damage to the bleed valves.

Sizes: 7, 8, 9, 11, 12, 14 mm

**Nr. 458 600 Brake bleeder wrench set**

Code: OE49000049

**CHANNEL LOCK**



**Perfekt zum Lösen** beschädigter Schraubenköpfe, Muttern, Stehbolzen, überdrehter Überwurfmutter, Bremsleitungen, Entlüfterschrauben. Diese Zange beißt sich bei Belastung immer weiter fest. Länge 175mm, Öffnung bis 20mm.

**Nr. CHA-307 Bremsen Zange**

Code: OE381003810



**Perfect for loosening** damaged screw heads, nuts, bolts, rounded union nuts, brake lines, bleed screws. These pliers bite firmly under load and grip tightly.

Length 175mm, opening up to 20mm.

**Brake plier**

## GELENKLEITUNGSSCHLÜSSEL LINE WRENCH WITH JOINT



**TOOL-INNOVATION**  
2006



**Alle Schlüssel einzeln erhältlich:**

All parts separately available:

	Nr.	Code		Nr.	Code
<b>SW6</b>	<b>457 7006</b>	OE19801980	<b>SW13</b>	<b>457 713</b>	OE27502750
<b>SW7</b>	<b>457 707</b>	OE19801980	<b>SW14</b>	<b>457 714</b>	OE27502750
<b>SW8</b>	<b>457 708</b>	OE19801980	<b>SW15</b>	<b>457 715</b>	OE27502750
<b>SW9</b>	<b>457 709</b>	OE19801980	<b>SW16</b>	<b>457 716</b>	OE29502950
<b>SW10</b>	<b>457 710</b>	OE19801980	<b>SW17</b>	<b>457 717</b>	OE29502950
<b>SW11</b>	<b>457 711</b>	OE19801980	<b>SW18</b>	<b>457 718</b>	OE29502950
<b>SW12</b>	<b>457 712</b>	OE19801980	<b>SW19</b>	<b>457 719</b>	OE29502950



**Ideal für Bremsleitungen, Servoleitungen, Klimaleitungen, Hydraulik-Verschraubungen.** Innen 6-kant, abgesetzter Bund für vertiefte Schrauben. Schwenkkopf.

**Nr. 457 705 Gelenkleitungsschlüssel 5-tlg.**  
Code: OE98000098  
**SW 8, 9, 10, 11, 12**

**Nr. 457 703 Gelenkleitungsschlüssel 3-tlg.**  
Code: OE58000058  
**SW 10, 11, 12**

**Nr. 457 701 Gelenkleitungsschlüssel 3-tlg.**  
Code: OE76000076  
**SW 14, 17, 19**



**Perfect for brake lines, servo steering lines, air condition, hydraulics.** Inner hex. Stepped flange shape.

**Line wrench kit, 5pcs.**  
**8, 9, 10, 11, 12mm**

**Line wrench kit, 3pcs.**  
**10, 11, 12mm**

**Line wrench kit, 3pcs.**  
**14, 17, 19mm**

## BREMSENENTLÜFTERSCHLÜSSEL SW11 BRAKE LINE WRENCH 11MM

**TOOL-INNOVATION**  
2004



**11mm lange Ausführung, Nr. 458 711**  
11mm long version, no. 458 711



**Spezial-Bremsenentlüfterschlüssel** zur Betätigung der Entlüfterschraube. Keine Demontage der Räder mehr notwendig. Nr. 458 711 passend für VW Golf 5, Audi A3, Seat Altea, Skoda Fabia etc.

Nr. 458 811 passend für VW Passat, Audi A4 etc.

**Nr. 458 711 Bremsenentlüfterschlüssel SW11**  
Code: OE46000046

**Nr. 458 811 Bremsenentlüfterschlüssel SW11 kurz**  
Code: OE46000046

Nr. 458 711-3 Silikonschlauch für Bremsenentlüfterschlüssel  
Code: OE19000019



**11mm kurze Ausführung, Nr. 458 811**  
11mm short version, no. 458 811



**Special brake bleeder wrench** for the actuation of bleeder screws. Without disassembly and assembly of the wheels. No. 458 711 e.g. for VW Golf 5, Audi A3, Seat Altea, Skoda Oktavia etc.

No. 458 811 e.g. for VW Passat, Audi A4 etc..

**Brake line wrench 11mm**

**Brake line wrench 11mm short**

Silicon-hose incl. nipple

## BREMSSATTEFEILE BRAKE CALIPER



**Flachscher an der Stirnseite**  
Scraper on the face end



**Bremssattel feile mit Flachscher** an der Stirnseite zur Entfernung von groben Rückständen.

**Nr. 460 200/M Bremssattel feile mit Heft**  
Code: OE28000028

**Nr. 460 202/M Bremssattel feile extra schmal für japanische Fahrzeuge**  
Code: OE298002980

**TOOL-INNOVATION**  
1982

**Nr. 460 200/M**



**Nr. 460 202/M Extra schmale Ausführung für japanische Fahrzeuge**  
Extra small application for Japanese vehicles



**Brake caliper file with scraper** on the face end for the removal of coarse residues.

**Brake caliper file with handle**

**Brake caliper thin for Japanese vehicles**

## BREMSEN-HONBÜRSTENSATZ BRAKE HONING BRUSH SET



Zur Reinigung der Führungsbolzen-Bohrung im Sattelgehäuse/Bremssattelträger bei Lucas und Ate Bremsen. Max. 500 Umdrehungen in der Minute und nur im Uhrzeigersinn (Rechtslauf) betrieben.

**Nr. 460 220 Bremsen-Honbürstensatz 2-tlg.**  
Code: OE68000068



To clean the guide pin hole in the caliper housing / brake caliper carrier on Lucas and Ate brakes. Max. 500 revolutions per minute and operated only in a clockwise direction (rotation direction).

**Brake honing brush set 2 pcs.**

## MINI-RATSCHEN ROHRABSCHNEIDER MINI-RATCHET PIPE CUTTER

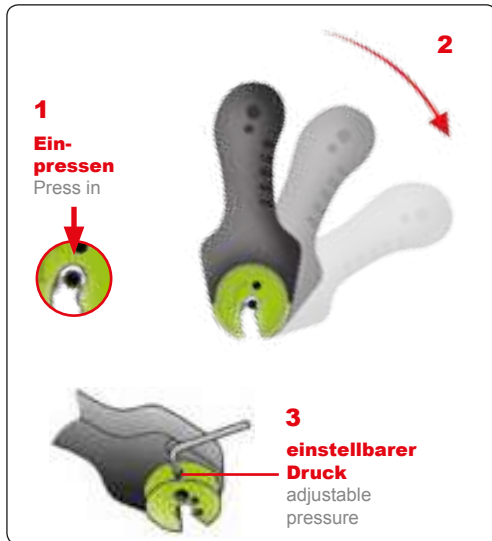

**Nr. 462 002 Mini-Ratschen Rohrabschneider**  
Code: OE340000034  
**Ø 4,75mm, 3/16"**



**Nr. 462 002 Mini-ratchet pipe cutter**  
Code: OE340000034  
**Ø 4,75mm, 3/16"**

## ABMANTELWERKZEUG FÜR BREMSLEITUNGEN BRAKE PIPE COATING REMOVAL TOOL



**Nr. 462 004 Abmantelwerkzeug für Bremsleitungen**  
Code: OE298002980



**Nr. 462 004 Brake pipe coating removal tool**  
Code: OE298002980



**Stufenlos einstellbar 3-16mm**  
Adjustable 3-16mm



## BREMSLEITUNGS-RICHTWERKZEUG BRAKE LINE STRAIGHTENER



Spezialwerkzeug zum Richten von Bremsleitungen 4,75mm. Einfache Handhabung ohne zusätzliche Werkzeuge etc.. Die Bremsleitung wird durch die 16 kugelgelagerten Präzisionsrollen ausgerichtet.

**Nr. 462 040 Bremsleitungs-Richtwerkzeug**

Code: OE890000089



Special tool to align the brake tube lines. Easy to use without any additional tools. The brake line will be straightened with 16 ball beared precision rolls.

**Nr. 462 040 Brake line straightener**

Code: OE890000089



**Lieferung in stabiler Metallbox.**  
Shipment in a rugged metalbox.

**4,75 + 6,0mm  
Spannbacken / Jaws**



**Bördelgerät zur Anwendung am Schraubstock.** Universell passend z.B. PKW + LKW Leitungen an Bremsen, Kupplungen, Servolenkungen etc. Für unbeschichtete Kupfer-, Stahl- und Alu-Leitungen geeignet. Backengrößen: 4,75mm (3/16"), 6mm (1/4"). Bördelarten: SAE, SAE/DIN.

**Nr. 463 001 Bördelgerät**

Code: OE298000298

Nr. 463 001/B475 Bördelersatz 4,75mm

Code: OE540000054

Nr. 463 001/B600 Bördelersatz 6,00mm

Code: OE540000054

Nr. 463 001/K475 Klemmbackensatz 4,75mm

Code: OE580000058

Nr. 463 001/K600 Klemmbackensatz 6,00mm

Code: OE580000058



**Flaring tool kit for use in a vice.** For non coated copper, steel, aluminium lines. Jaws: 3/16" (4mm), 1/4" (6.0mm) SAE, SAE/DIN.

**Flaring tool**

Flaring adapter 4.75mm

Flaring adapter 6.00mm

Jaws 4.75mm

Jaws 6.00mm

## BÖRDELGERÄT FLARING TOOL

**SAE Zwilling's-Ausführung**

SAE double 3/16" - 4,75mm

**SAE CONVEX**

3/16" - 6mm

**SAE/DIN Zwilling's-Ausführung**

SAE/DIN double 1/4" - 6mm

**SAE/DIN CONVEX**

1/4" - 6mm

## **BREMSLEITUNGS-BIEGEVORRICHTUNG** **BRAKE PIPE BENDER**



**Biegen der Bremsleitung auf engstem Raum** ohne Knicken und Beschädigungen. Einsatz am Schraubstock oder direkt am Fahrzeug. Für Durchmesser 4,75 + 6,0 mm.

### **Nr. 463 006 Bremsleitungs-Biegevorrichtung**

Code: OE990000099



**To bend the brake pipe in a confined space** without kinking and damage. Use in a vice or directly on the vehicle. For diameters 4.75 mm + 6.0 mm

### **Nr. 463 006 Brake pipe bender**

Code: OE990000099

## **BREMSLEITUNGS-BIEGEZANGE** **BRAKE PIPE BENDING PLIERS**



**Biegen der Bremsleitung auf engstem Raum** ohne Beschädigung und ohne Knicken. Biegungen bis 90° möglich. Auch zum Halten des Bremsrohres beim Abschneiden.

### **Nr. 463 007 Bremsleitungs-Biegezange**

Code: OE900000090



**To bend the brake pipes in a confined space** without damage and without kinking. Bends possible up to 90°. Also for holding the brake pipe during cutting.

### **Nr. 463 007 Brake pipe bending pliers**

Code: OE900000090

## **BREMSLEITUNGS-ROLLEN-BIEGEZANGE** **BRAKE PIPE BENDING PLIER**



Für beschichtete und unbeschichtete Bremsleitungen 4,75 + 5mm. Keine Beschädigung durch rotierende Rollen.

### **Nr. 463 009 Bremsleitungs-Rollen-Biegezange**

Code: OE680000068



For coated and uncoated brake pipes 4,75 + 5mm. No damage through rotating rolls.

### **Nr. 463 009 Brake pipe bending plier**

Code: OE680000068



# HANDBÖRDELGERÄT HAND FLARING TOOL

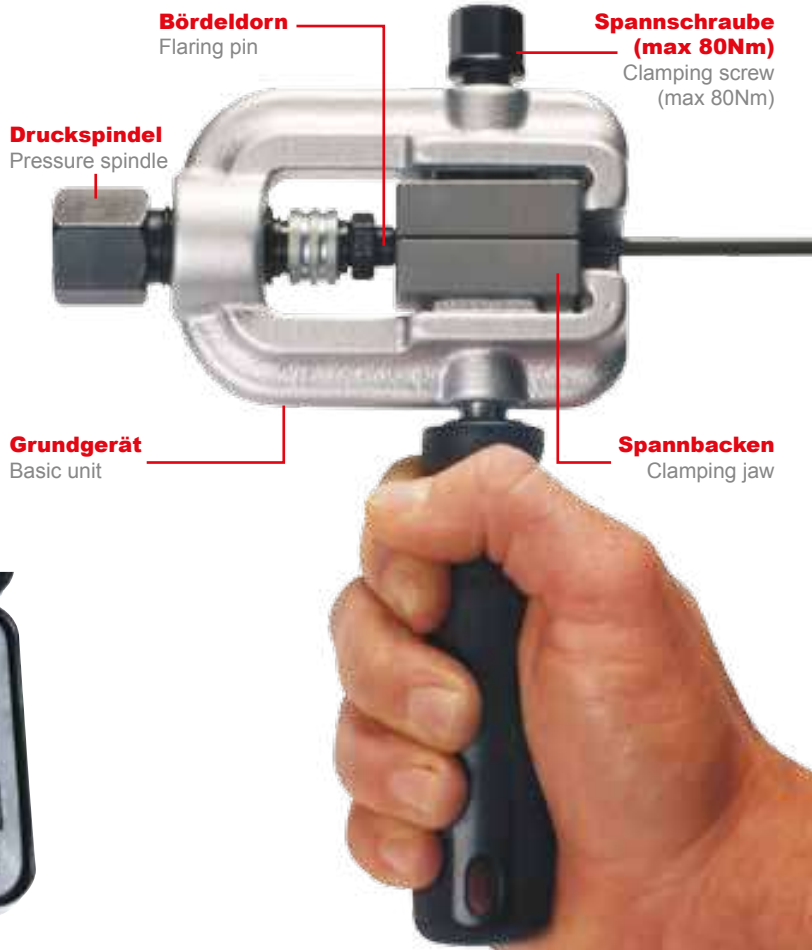
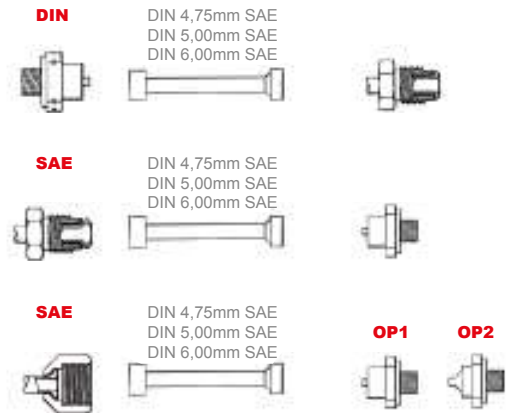

**Handbördelgerät zur Anwendung direkt am Fahrzeug.** Universell passend z.B. PKW + LKW Leitungen an Bremsen, Kupplungen, Servolenkungen etc. Für unbeschichtete Kupfer-, Stahl- und Alu-Leitungen geeignet. Backengrößen: 4,75mm (3/16"), 5mm, 6mm. Bördelarten: SAE, DIN, SAE/DIN.

## Nr. 463 020

Code: OE198000198

Nr. 463 020/HS

Code: OE940000094

Nr. 463 021

Code: OE248002480

Nr. 463 022/B-Konus

Code: OE185001850

Nr. 463 022/B475DIN

Code: OE185001850

Nr. 463 022/B475SAE

Code: OE185001850

Nr. 463 022/B6DIN

Code: OE185001850

Nr. 463 022/B6SAE

Code: OE185001850

Nr. 463 022/K475

Code: OE370000037

Nr. 463 022/K5

Code: OE370000037

Nr. 463 022/K6

Code: OE370000037

## Handbördelgerät

Hydraulikspindel für Bördelgerät

Bremsleitungsverbinder  
Made in Germany, 5er Pack

Bördeleinsatz 4,75 - 6mm Konus/SAE 90°

Bördeleinsatz 4,75 / 5mm DIN

Bördeleinsatz 4,75 / 5mm SAE

Bördeleinsatz 6mm DIN

Bördeleinsatz 6mm SAE

Klemmbackensatz 4,75mm DIN/SAE

Klemmbackensatz 5mm DIN/SAE

Klemmbackensatz 6mm DIN/SAE



**Flaring tool kit for the use directly on the car.** For non coated copper, steel, aluminium lines. Jaws: 4.75mm, 5.0mm, 6.0mm SAE, DIN, SAE/DIN.

## Hand flaring tool

Hydraulic spindle for hand flaring tool

Brake line connector 5pack

Flaring adapter 4.75 - 6mm cone / SAE 90°

Flaring adapter 4.75 / 5mm DIN

Flaring adapter 4.75 / 5mm SAE

Flaring adapter 6mm DIN

Flaring adapter 6mm SAE

Jaws 4.75 DIN/SAE

Jaws 5mm DIN/SAE

Jaws 6mm DIN/SAE



## BREMSSATTEL-BÜRSTENSATZ BRAKE CALIPER BRUSH KIT



**Zum Entfernen von hartnäckigen und ein-gebrannten Rückständen an Bremssätteln.** Anwendung Messing: Zur Verwendung an Aluminium-Sätteln. Länge: 225mm.

### Nr. 467 000 Bremssattel-Bürstensatz

Code: OE198001980

Nr. 467 001 Bremssattelbürste Stahl

Code: OE110000011

Nr. 467 002 Messing-Bremssattelbürste

Code: OE110000011



**To remove burned in brake dust and dirt from brake calipers.** Set includes 1 steel brush and 1 brass brush. Application for brass brush: Use on aluminium brake calipers. Soft brass bristles ensure a proper cleaning. Length: 225mm.

### Nr. 467 000 Brake caliper brush kit

Code: OE198001980

Nr. 467 001 Brake caliper brush steel

Code: OE110000011

Nr. 467 002 Brake caliper brush brass

Code: OE110000011

#### Messingborsten für Alu-Sättel

Brass bristles for Aluminium

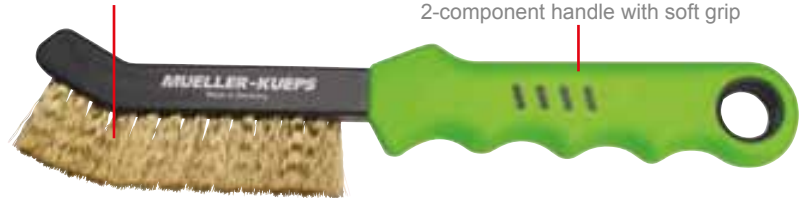

#### 2-Komponenten Softgriff

2-component handle with soft grip



#### Schmale Ausführung

Ultra slim design



## RATSCHENRÜCKSETZER FÜR BREMSKOLBEN BRAKE CALIPER PRESS



**Passend zur Anwendung bei Bremssätteln mit 1, 2 oder auch 4 Bremskolben.** Durch zentrische und gleichmäßige Kraftübertragung wird das Verklemmen der Bremskolben vermieden. Universell verwendbar. Umschaltbarer Ratschenmechanismus. Gute Zugänglichkeit an der Bremse durch 360° drehbaren Handgriff.

### Nr. 468 015 Ratschenrücksetzer für Bremskolben

Code: OE780000078



**Works on various single, dual & quad piston calipers.** Centers force to prevent misalignment of pistons. 360 degree ratchet swing allows access at any angle.

### Nr. 468 015 Brake caliper press

Code: OE780000078



#### Bremskolben wird gleichmäßig von allen Seiten gedrückt. Somit kein verkanten.

The brake piston is pushed evenly on all sides. Therefore, there is no tilting.

## BREMSKOLBEN DRUCK-DREHVORRICHTUNG BRAKE PISTON PRESSURE-TURN DEVICE



**TOOL-INNOVATION**  
1996



**Passend für nahezu alle Bremskolben**  
Fits for almost all brake pistons



**Komplettwerkzeug mit Links- und Rechtsgewinde-spindel** zum Zurücksetzen des Bremskolbens an Schwimmsätteln. Universell passend z. B. für VW, Opel, BMW, Audi, Ford etc. Linksgewindespindel speziell für Ford, Citroen, Mazda, Renault.

**Nr. 468 020 Bremskolben  
Druck-Drehvorrichtung**  
Code: OE116000116



**Complete tool with left-hand and right-hand threaded spindle** for the re-setting of the brake piston in floating calipers. Universally suitable e.g. for VW, Opel, BMW, Audi, Ford etc. Left-hand threaded spindle especially for Ford, Citroen, Mazda, Renault.

**Brake piston pressure-turn device**

## DRUCKLUFT-BREMSEN-RÜCKSETZER AIR BRAKE PISTON RESETTER



**Universelle Anwendung, passend auch für Müller 468 020 Adapterplatten.** Geeignet für Links- und Rechtsgewinde Bremskolben. Lieferung in Schaumstoffeinlage, 6-8bar.

**Nr. 468 026 Druckluft-Bremsen-Rücksetzer**  
Code: OE198000198



**Universal use, fits also for Mueller 468 020 adapters.** Works for left and right threaded brake pistons. Includes foam inlay, 6-8bar.

**Nr. 468 026 Air brake piston resetter**  
Code: OE198000198



## UNI BREMSKOLBEN DRUCK- + DREHVORRICHTUNG BRAKE PISTON PRESS + TURN DEVICE

**Drehen und Drücken - alles in einem Arbeitsgang**

Turning and Pressing - all in one Movement



**Nr. 468 020/S**  
**Druckspindel Rechts**  
spindel right

**Nr. 468 020/SL**  
**Druckspindel Links**  
spindel left

**Nr. 468 020/1**  
**Gegenhalteplatte**  
counter plate



Nr. 468 023

**Nr. 468 020/48**  
**Universal 3 Arm**  
**Druckscheibe**  
3 pin adjustable disc

**Nr. 468 020/47**  
**Universal 2 Arm**  
**Druckscheibe**  
2 pin adjustable disc



**Zum Rücksetzen der hinteren Bremskolben.** 2+3 armige Druckscheiben stellen sich automatisch auf den entsprechenden Durchmesser ein. Sehr schlanke Ausführung der Druckscheiben.

- universell verwendbar
- zeitsparend

**Nr. 468 023 Uni Bremskolben Druck- und Drehvorrichtung**  
Code: OE148000148



**Professional reset of the rear axle brake pistons.** The exact distance of the rotating disc adapts automatically to the bores of the brake piston by turning the basic unit of the disc.

- Repair almost every car with these two discs!
- Time saver

**Brake Piston Press and Turn Device**

## 2 + 3 ARM UNI BREMSENDRUCKSCHEIBEN SATZ 2 + 3 PIN ADJUSTABLE DISC SET



**Nr. 468 021 2 + 3 Arm Uni Bremsendruckscheiben Satz**  
Code: OE980000098

Nr. 468 020/47 Druckscheibe 2 Arm  
Code: OE540000054

Nr. 468 020/48 Druckscheibe 3 Arm  
Code: OE580000058



**Nr. 468 021 2 + 3 pin adjustable disc Set**  
Code: OE980000098

Nr. 468 020/47 2 pin adjustable disc  
Code: OE540000054

Nr. 468 020/48 3 pin adjustable disc  
Code: OE580000058



**Nr. 468 020/47**  
**Universal 2 Arm**  
**Druckscheibe**  
2 pin adjustable disc

**Nr. 468 020/48**  
**Universal 3 Arm**  
**Druckscheibe**  
3 pin adjustable disc

## 1/2" x 600mm KNARREN-KNEBEL 1/2" x 600mm RATCHET BREAKER BAR



Für festsitzende Schraubverbindungen. Schwenkkopf 210° für schwer zugängliche Stellen.

**Nr. 512 610** 1/2" x 600mm  
Code: OE65000065  
**Knarren-Knebel**



Busts loose stubborn bolts. Swivel head design allows multiple positions, including the ability to use it straight as a speed handle for hard to reach areas.

**1/2" x 600mm Ratchet breaker bar**

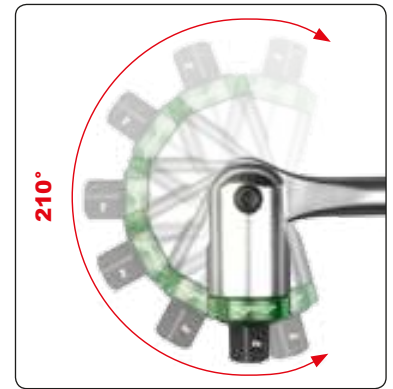

## XS-BIT SATZ XS-BIT KIT



**Nr. 514 513**



**Nr. 514 413**



**Ultra kurz & ultra starker Bit-Satz.** 21 extra kurze Bits in T, XZN & 6-kant Ausführung. Bit-Höhe 20mm! 2 verstellbare Knarren-Ringschlüssel zur Anwendung an schwer zugänglichen Stellen. Inkl. 1/4" & 3/8" Stecknuss-Adapter. Bits in folgender Ausführung:

**T:** T15, T20, T25, T27, T30, T40, T45, T50, T55  
**XZN:** M4, M5, M6, M8, M10  
**6-kant:** 4, 5, 6, 7, 8 & 10mm  
**Adapter:** 1/4" & 3/8"

**Nr. 514 600** XS-Bit Satz  
Code: OE168000168



**Ultra short & ultra strong XS-Bit Kit.** 21 bits in an extra short version, 20mm. 2 different ratcheting wrenches. The gear ratchet mechanism allows the work on narrow space areas. The kit includes 1/4" & 3/8" socket adapter. Bits:

**T:** T15, T20, T25, T27, T30, T40, T45, T50, T55  
**XZN:** M4, M5, M6, M8, M10  
**6-kant:** 4, 5, 6, 7, 8 & 10mm  
**Adapter:** 1/4" & 3/8"

**Nr. 514 600** XS-Bit Kit  
Code: OE168000168



**extra kurz & ultra stark**  
**extra short & ultimately strong**

## ABSAUGBALG FLUID SUCTION DEVICE



**Zum tropffreien Absaugen von Bremsflüssigkeit aus dem Ausgleichsbehälter.** Geeignet für Bremsflüssigkeit und Batteriesäure.

**Nr. 515 008 Absaugbalg**

Code: OE128001280



**For drip-free suction of brake fluid from the master cylinder reservoir.** Suitable for brake fluid and battery acid.

**Fluid suction device**

## UNIVERSAL BREMSSEN-ENTLÜFTER UNIVERSAL BRAKE BLEEDER



**Durch das integrierte Venturisystem wird ein kraftvolles Vakuum erzeugt.** Universal-Nippel, auch für einige ABS Systeme geeignet.

Inhalt: 2 Liter, Höhe: 27cm

**Nr. 515 009/V2 Universal Bremsen-Entlüfter**

Code: OE168000168



**Works with the integrated venturi system. Produces a strong vacuum which bleeds the brake system.** With universal nipple, also fits for some ABS systems. 2 litre.

**Nr. 515 009/V2 Universal brake bleeder**

Code: OE168000168



## 1/2" DREHMOMENTSCHLÜSSEL 1/2" TORQUE WRENCH

+/- 3% →

### Präzisions-Werkstattqualität

Professional workshop tool



**Präzisionswerkzeug.** Deutlich hör- und fühlbares Auslösesignal. Genauigkeit von +/-3%. Deutlich sichtbare und verriegelbare Skala. Eindeutige Produktidentifikation durch Werkzeug-Seriennummer. Komplettservice für Drehmomentschlüssel. Jeder Drehmomentschlüssel wird mit individuellem Prüfzertifikat geliefert.

**Nr. 531 010 1/2" Drehmomentschlüssel  
20-200 Nm**  
Code: OE128000128



**Top class tool.** Feel and hear the signal. Tolerance +/-3%. Handy and ergonomic 2-component handle. Scale is lockable and good visible. Product identification based on serial number of each tool. Each torque wrench will be supplied with individual test report certification.

**1/2" Torque wrench 20-200 Nm**



## TPMS/RDKS REIFENENTLÜFTER TYRE DEFLATOR KIT



**Zum Entlüften der Reifen beim Montieren der TPMS/RDKS Raddrucksensoren.** Farbcodierung zur korrekten Montage des Rades. Meistens kann die Neuprogrammierung der Sensoren entfallen.

**Nr. 531 054 TPMS/RDKS Reifenentlüfter 4-tlg.**  
Code: OE28000028



**Release air from tires without removing or damaging TPMS valve core.** Color coded to help correct tire mounting. Not needed to reset the TPMS.

**Nr. 531 054 Tyre Deflator Kit, 4pcs.**  
Code: OE28000028



**TPMS/RDKS WERKZEUG-SATZ**  
**TPMS/RDKS TOOL KIT**



**Wird benötigt zur Montage und Demontage der ventilbasierten Reifendruck Kontrollsensoren TPMS/RDKS.** Diese Werkzeuge vermeiden ein Überdrehen oder Unterdrehen empfindlicher Bauteile wie z. B. Überwurfmutter oder Ventileinsatz.

Herstellerspezifische Drehmomente werden eingehalten und die Funktionalität der Bauteile gewährleistet.

Bestehend aus 6 Stück T-Griff Schlüssel mit Nm-Begrenzung sowie verschiedenen Spezial-Stecknüssen.

Passend für nahezu alle am Markt befindlichen Sensoren.

**Nr. 531 049 TPMS/RDKS Werkzeug-Satz**

Code: OE248000248



**Needed for mounting and demounting of the valve-type TPMS sensors.** These tools ensure that the sensitive TPMS-sensors parts as hex-nut or valve core will be tight with the proper torque, which is required by the TPMS sensor manufacturer.

6pcs T-handle with Nm-Limiter and special sockets kit. This kit fits for nearly all TPMS sensors on the market.

**TPMS/RDKS Tool kit**

**GELENKSCHLÜSSEL SATZ**  
**JOINT KEY KIT**



Nr. 545 600



Für schwer zugängliche Stellen. Das lästige Umsetzen des Schlüssels entfällt durch den Schwenkkopf.

**Nr. 545 600 Gelenk 6-kant Stiftschlüssel Satz 6-tlg.**

Code: OE680000068

**Nr. 545 700 Gelenk T Schlüssel Satz 6-tlg.**

Code: OE680000068



Nr. 545 700



Swivel head hex wrench for hard to reach areas.

**Joint hex key kit 6pcs.**

**Joint T-key kit 6pcs.**



**180° Gelenk / 180° swivel**

3 Bremse & Rad Brake & Wheel  
4 Motor Engine-Tools  
5 Zerspanung Cutting Tools  
6 Karosserie/Verschleiß AutoBody/Consumables  
7 Universal-Werkzeuge Universal Tools  
8 Transporter & LKW Heavy Duty & Trucks  
9 Equipment  
Inhaltsverzeichnis Table of Contents



## MAUL-RINGSCHLÜSSEL SATZ EXTRA KURZ COMBINATION WRENCH KIT



- ergonomisch perfekt
- nirgends scharfe Kanten
- neue ISO-Größen 16 + 18mm
- neuartiges, kombiniertes Maulprofil

- ergonomic design
- no sharp edges
- new sizes 16 + 18 mm
- new open end design



**Sehr kurzer und handlicher, leicht gekröpfter** 10-teiliger Maul-Ringschlüssel Satz. Zum Einsatz an schwer zugänglichen Stellen wie z. B. Bremsen, Motor, Türen, Armaturenbrett etc.

**Nr. 711 100 Maul-Ringschlüssel Satz extra kurz**  
Code: OE98000098



**Extra short and handy 10 pcs. combination wrench kit** 10 - 19 mm. Use for hard to reach areas such as engine, doors, electric, dashboard, radio etc.

**Combination Wrench Kit**

## SCHUTZKAPPENHEBER SPEED LOADER



**Passend für alle gängigen Schutzkappen SW 17**  
For all plastic protection caps, 17mm



**Aufbewahrung aller Schutzkappen im Griff. (bis zu 20 Stk.)**

Store all wheel caps in the handle. ( up to 20 pcs. )



**Für De- und Montage der Schutzkappen** an Radbolzen. Rohrgriff dient zur Aufbewahrung aller Schutzkappen eines Fahrzeuges (20 Stück). Für alle uns bekannten Schutzkappen (SW 17mm) verwendbar. Schlanke Ausführung auch für extrem tief liegende Anwendungen. Universelle Anwendung: z. B. Opel, Audi, Seat, Skoda, VW, GM etc.

**Nr. 800 005 Schutzkappenheber**  
Code: OE32000032

**Nr. 800 005/3 Schutzkappenheber VPE 3 Stk.**  
Code: OE89000089

**Nr. 800 005/M Schutzkappenheber mit Haltemagnet**  
Code: OE42000042



**For demounting, storage and installing the plastic protection caps** of the wheel bolts. Tube handle construction to store the caps. No mess based on searching for lost caps. Fits universal for all caps 17mm. Slim construction for deep placed bolts. Universal use e.g. Opel, GM, Audi, Skoda, etc.

**Speed loader**

**Speed loader, 3 pcs.**

**Speed loader incl. Magnet holder**

**STECKNUSS-SATZ FÜR ALUFELGEN**  
**SOCKET SET FOR ALUMINIUM RIMS**

**TOOL-INNOVATION**  
**1998**

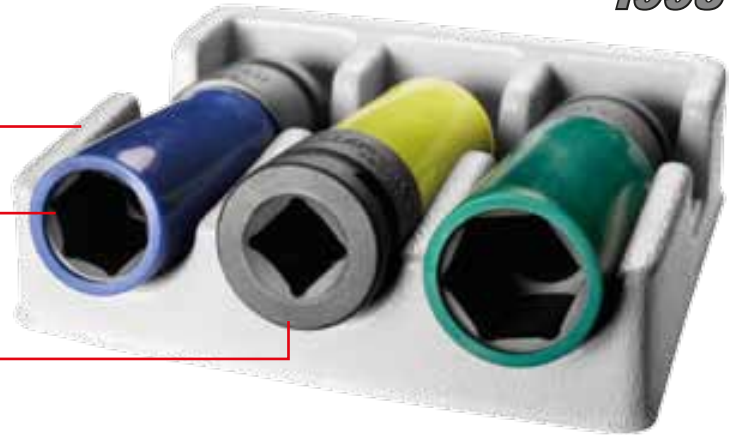

**Größen: SW17, 19 + 21 x 1/2"**  
Sizes: 17, 19 + 21mm x 1/2"

**Kunststoffanschlag zum Schutz der verchromten Radbolzen/Radmuttern**  
Plastic inlay for the protection of the wheel bolts and wheel nuts

**Schlagschrauberfest**  
Impact wrench proof



**Hochwertige, dünnwandige Schlagstecknüsse** zur beschädigungsfreien De- und Montage von Aluminiumfelgen in der Fachwerkstatt. Kunststoffhülse zum Schutz der Felge. Kunststoffanschlag innen zum Schutz von verchromten Radbolzen. Die einzelnen Größen SW17, 19, 21 sind durch unterschiedlichen Farbcode zu erkennen. Länge 80mm-

**Nr. 800 100 Stecknuss-Satz für Alufelgen**  
Code: OE360000036



**High-quality, thin-walled impact sockets** for the damage-free removal and mounting of aluminium rims in specialist workshops. Plastic sleeve for the protection of the rim. The individual sizes wrench opening 17, 19, 21 are colour-coded. Length: 80mm.

**Socket set for aluminium rims**

**XL-RADMONTAGE-STECKNUSS-SATZ**  
**XL WHEEL MOUNTING SOCKET KIT**

**TOOL-INNOVATION**  
**2004**



**Größen: SW17, 19 + 21 x 1/2"**  
Sizes: 17, 19, 21mm x 1/2"

**Extra lange und dünnwandige Ausführung**  
Extra long and thin walled design



**Hochwertige extra lange, dünnwandige Ausführung** aus einem Stück. Zur ergonomisch optimalen De- und Montage von Rädern in der Fachwerkstatt. Größen sind durch unterschiedlichen Farbcode zu erkennen.

**Nr. 800 200 XL-Radmontage Stecknuss-Satz 3-tlg.**  
Code: OE790000079

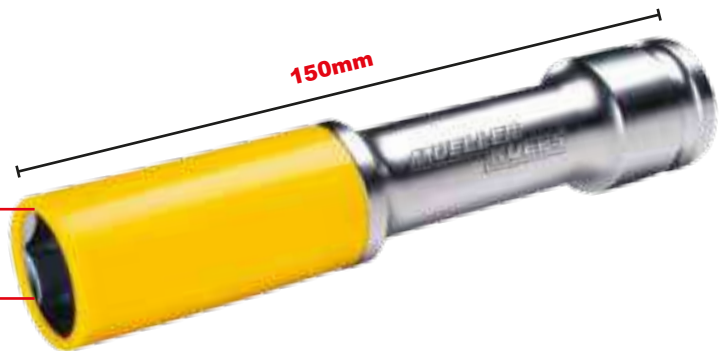

**High-quality, extra long, thin-walled single-piece design.** Ergonomic design for removal and mounting of wheels in specialist workshops. For use with Torque Wrench! The individual sizes are colour-coded.

**XL wheel mounting socket kit 3pcs.**

3  
Brems- & Rad  
Brake & Wheel

4  
Motor  
Engine-Tools

5  
Zerspanung  
Cutting Tools

6  
Karosserie/Verschleiß  
AutoBody/Consumables

7  
Universal-Werkzeuge  
Universal Tools

8  
Transporter & LKW  
Heavy Duty & Trucks

9  
Equipment

Inhaltsverzeichnis  
Table of Contents

## SCHLAG-VERLÄNGERUNGS-SATZ IMPACT LOCKING EXTENSION KIT



2tlg., 125 + 250mm, 1/2" Antrieb, mit Verriegelung. Ermöglicht einen sicheren und festen Sitz der Stecknuss.

### Nr. 807 020 Schlag-Verlängerungs-Satz

Code: OE480000048

Nr. 807 003  
Code: OE320000032

Schlag-Verlängerung 125mm x 1/2"  
mit Verriegelung

Nr. 807 004  
Code: OE380000038

Schlag-Verlängerung 250mm x 1/2"  
mit Verriegelung



2pcs, 125 + 250mm 1/2", with locking mechanism. Ensures safe and tight connection of the impact sockets

### Impact locking extension kit

Impact locking extension 125mm x 1/2"

Impact locking extension 250mm x 1/2"



## POLYGON-IMPACT GELENK SATZ POLYGON IMPACT JOINT KIT



**Spezielle Kugel mit Flächen garantiert maximale Kraftübertragung. Rastmechanismus.** Dadurch als Gelenk und starr einsetzbar. 1/4", 3/8", 1/2"

### Nr. 810 203 Polygon-Impact Gelenk Satz 3-tlg.

Code: OE680000068



**Special ball with flat areas ensures maximum torque transfer.** Works as joint and straight connector. 1/4", 3/8", 1/2"

### Nr. 810 203 Polygon Impact Joint Kit 3pcs.

Code: OE680000068



## XS-STUBBY IMPACT SATZ EXTRA KURZ XS-STUBBY IMPACT SOCKET KIT 10-24MM ON RAIL



**Ideal zur Verwendung an schwer zugänglichen Stellen durch die einzigartige extra kurze Bauhöhe.**

Lieferung komplett auf Steckleiste.

### Nr. 810 700 XS-Stubby Impact Satz extra kurz, Antrieb 1/2" 10-24mm auf Leiste

Code: OE980000098



**Ideal to access hard to reach areas based on the unique short construction.**

Delivery on rail.

### XS-Stubby Impact socket kit 10-24mm on rail

**28mm extra kurz**  
extra short



**Alle Nüsse einzeln erhältlich (siehe Preisliste).**

All parts separately available (see price list).

## KRAFT-KUGELGELENK-STECKNUSS-SATZ IMPACT BALL JOINT SOCKET KIT



**Speziell zur Verwendung an Radaufhängungen, Stoßdämpfern, Bremsen etc. Kugelgelenk 30° abwinkelbar. Schlagschrauberfest.**

**Nr. 810 689 Kraft-Kugelgelenk-Stecknuss-Satz, 4-tlg. SW16, 17, 18, 19 x 1/2"**  
Code: OE109000109



**Perfect for axle connections, shock absorbers, brakes etc. Ball joint 30° swivel. Impact gun resistant.**

**Nr. 810 689 Impact ball joint socket kit, 4pcs. 16, 17, 18, 19mm x 1/2"**  
Code: OE109000109



## KNIE-SCHUTZKISSEN KNEE PROTECTION-PAD

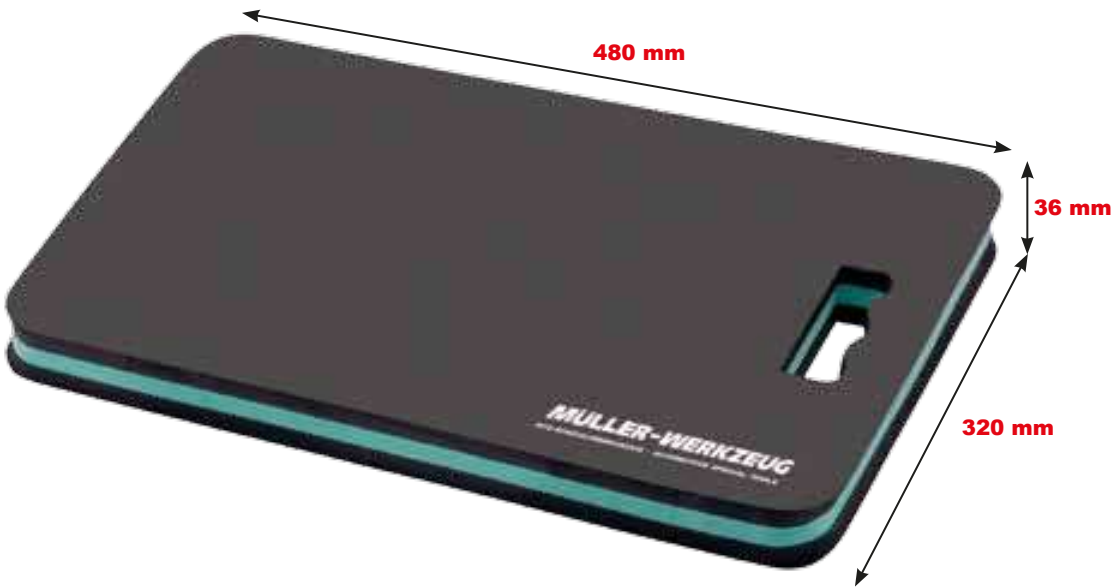

**Professionelles Erscheinungsbild der Werkstatt.** Keine Verwendung von Putzlappen, Kartons etc. Wasser-, benzin- und ölabweisend. Wärmespeichernd durch 3-lagiges Softmaterial. Gesundheitsvorsorge: auch als Sitzauflage geeignet.

**Nr. 905 000/3 Knie-Schutzkissen Pack, 3 Stk.**  
Code: OE540000054

**Nr. 905 000/10 Knie-Schutzkissen Pack, 10 Stk.**  
Code: OE178000178



**Professional workshop equipment.** No use of old cartons etc. Water, oil and gasoline resistant. Health protection, 3-layer soft material. Can be used for seat protection as well.

**Knee protection-pad, 3pcs.**

**Knee protection-pad, 10pcs.**

## RATSCHEN SPANNLEINE RATCHET-ROPE

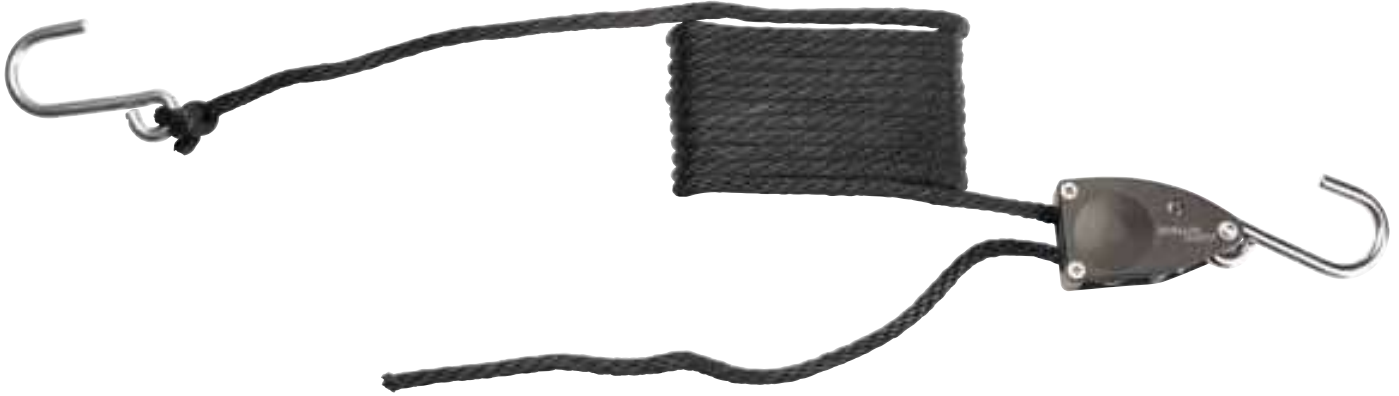

Zur fachgerechten Positionierung und Fixierung des Brems-  
sattels und anderer Teile.

**Nr. 905 018**  
Code: OE198001980

**Ratschen Spannleine bis 25 kg**

**Nr. 905 019**  
Code: OE248002480

**Ratschen Spannleine bis 40 kg**



Helpfull to fix brake caliper, exhaust muffler etc.

**Ratchet-Rope up to 25 kg**

**Ratchet-Rope up to 40 kg**



## RADHEBER WHEEL LIFTER



Einfache und sichere Demontage und Montage von  
Komplettädern bis 50 kg bei PKW und Transportern.  
Mechanische Ausführung, Betätigung mit Schlag-  
oder Akkuschauber.

**Nr. EQ-1251 Radheber**

Code: OE628000628



Easy handling of wheels up to 50 kg.  
Unit is driven by impact gun or cordless gun.

**Nr. EQ-1251 Wheel lifter**

Code: OE628000628

### MÜLLER-WERKZEUG

#### Technische Daten / technical information

<b>Max / capacity</b>	kg	50
<b>Arbeitshöhe / lift range</b>	m	1,08
<b>Gewicht / weight</b>	kg	51

## UNI-HAKENSATZ UNI-HOOK-KIT

**Nr. 905 022**  
**biegbar / universell anpassbar**  
 bendable / universally adjustable



**Nr. 905 024**  
**starr**  
 inflexible

**z. B. für Bremssättel,  
 Kabel etc.**  
 i. e. brake caliper, cords etc.



Hakensatz zur universellen Anwendung wie z. B. Aufhängen des Bremssättels, Aufbewahrung von Schläuchen oder Kabeln.

**Nr. 905 022** **Uni-Hakensatz,**  
 Code: OE118001180 **biegbar / universell anpassbar**

**Nr. 905 024** **Uni-Hakensatz,**  
 Code: OE118001180 **starr**



Hook-kit for universal applications such as brake caliper, cables, hoses etc.

**Nr. 905 022** **Uni-Hook-Kit,**  
 Code: OE118001180 **bendable / universally adjustable**

**Nr. 905 024** **Uni-Hook-Kit,**  
 Code: OE118001180 **inflexible**

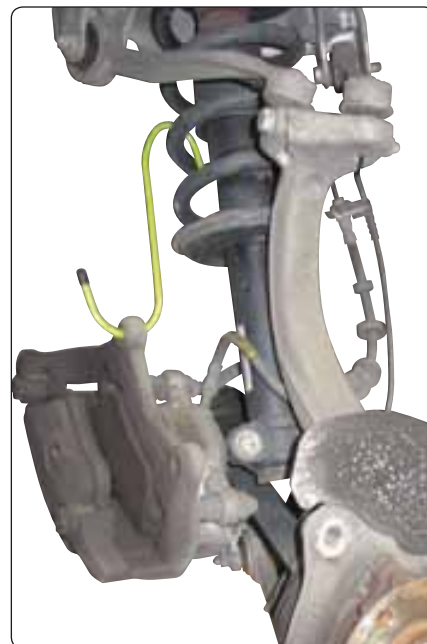

3  
 Bremse & Rad  
 Brake & Wheel

4  
 Motor  
 Engine-Tools

5  
 Zerschneidung  
 Cutting Tools

6  
 Karosserie/Verschleiß  
 AutoBody/Consumables

7  
 Universal-Werkzeuge  
 Universal Tools

8  
 Transporter & LKW  
 Heavy Duty & Trucks

9  
 Equipment

Inhaltsverzeichnis  
 Table of Contents



# MOTOR ENGINE



**MÜLLER Tipp:**  
elektronisches Dokument  
Artikelsuche mit "Strg + F"

**MUELLER Tip:**  
electronic document  
Product Search "Ctrl + F"

**Apple:** "⌘ + F"

## AUSPUFF-ROHRERWEITERER EXHAUST PIPE EXPANDER

**Nr. 403 192/2**  
Code: OE465004650

**Gesamtlänge** / Length: **210mm**  
**Spannbereich** / Clamping range: **54 - 85mm**



**Nr. 403 192/1**  
Code: OE465004650

**Gesamtlänge** / Length: **165mm**  
**Spannbereich** / Clamping range: **36 - 54mm**



**Hochwertige 2-tlg. Ausführung** mit 6-kant Antrieb. Exaktes Aufweiten des Auspuffrohres durch 2 gegenüberliegende Spannkegel mit Flächen.  
Länge: 165 bzw. 210mm. Arbeitsbereich: Ø 36-85mm.

**Nr. 403 192 Auspuff-Rohrerweiterer, 2-tlg.**  
Code: OE930000093



**High quality 2 pcs. kit.** Exact expanding based on 2 cone with flats. Length: 165 / 210mm. Diameters: Ø 36-85mm.

**Nr. 403 192 Exhaust pipe expander set, 2 pcs.**  
Code: OE930000093

## LÖSUNGEN FÜR SCHLAUCHKLEMMEN HOSE CLAMP SOLUTIONS



**Nr. 500 015**



**Nr. 500 016**

**Spannbereich von 8 -70mm**  
Clamping range 8 -70mm



**Selbstspannende Schelle**  
Special hose clamp



**Nr. 500 014**

**Arretierungs-Vorrichtung für selbstspannende Schellen**  
Adjustment - unit for special hose clamps



**Nr. 500 012**

**Spannbereich: 8 - 52mm**  
Clamping range: 8 - 52mm



**Zange** für schwer zugängliche selbstspannende Federbandschellen. Durch das 600 mm lange flexible Zwischenstück für schwer zugängliche Stellen geeignet.

**Nr. 500 012 Schlauchklemmzange mit Arretierung**  
Code: OE980000098

**Nr. 500 014 Spezialklemmzange mit Arretierung**  
Code: OE118000118

**Schlauchklemmspanner**, klein & kompakt, für schwer zugängliche Stellen. Spannbereich 8 - 70mm. Typ 1 universal, Typ 2 besonders geeignet für die extrem flachen Federbandschellen des Ladeluftschlauches bei VW/Audi.

**Nr. 500 015 Schlauchklemmspanner Typ 1**  
Code: OE360000036

**Nr. 500 016 Schlauchklemmspanner Typ 2, VW/Audi**  
Code: OE490000049



**Special plier for hose clamps** in narrow spaces. Universal use. Perfect and save to grip also very strong hose clamps. Integrated ratchet mechanism to fix in each position.

**Hose clamp plier flexible**

**Special hose clamp plier flexible**

**Special hose clamp compressor.** Clamping-range: 8 - 70mm. 1/4" drive to fix in each position. Universal use. Type 2 made especially for the very flat clamps of the supercharge-air-hose at VW/Audi.

**Hose clamp compressor type 1**

**Hose clamp compressor type 2, VW/Audi**



## DOPPELGELENK- SCHLAUSCHSCHELLEN ZANGEN-SATZ DOUBLE-X-HOSE CLAMP PLIER KIT

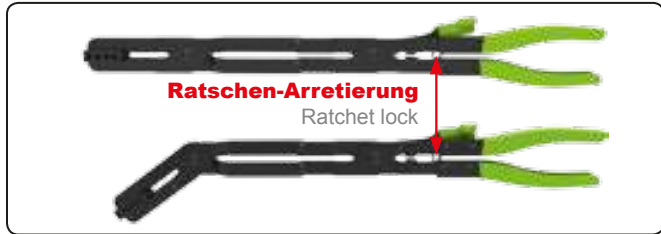

Universell verwendbar für tiefliegende und schwer erreichbare Schlauchschellen im gesamten Motorraum. Doppelgelenk Mechanismus. Neuartiger Greifkopf für fast alle Positionen. Ratschen-Multi-Arretierung hält die Schlauchklemme offen. Länge 440mm.

**Nr. 500 030 Doppelgelenk-Schlauchschellen Zangen-Satz 2tlg.**  
Code: OE98000098



Universal use for hard to reach areas and narrow spaces. Double joint mechanism. New head design for multi angle gripping. Ratchet lock holds the hose clamp open. Length 440mm.

**Nr. 500 030 Double-X-hose clamp plier kit**  
Code: OE98000098



Universal-Zangensatz für verschiedene Schlauchklemmen. Neuartiger Greifkopf für fast alle Positionen. Ratschen-Multi-Arretierung hält die Schlauchklemme offen. Länge: 280mm

**Nr. 500 035 Schlauchschellen-Zangensatz 2tlg.**  
Code: OE68000068



**Ratschen-Arretierung**  
Ratchet lock



Universal hose clamp plier kit. New head design for multi angle gripping. Ratchet lock holds the hose clamp open. Length 280mm.

**2pcs hose clamp plier kit**

## ZANGE FÜR CLIC-SCELLEN, DREHBAR PLIER FOR CLIC HOSE CLAMP

**Drehbares Klemmelement**  
Turnable gripping piece



**Universelle Verwendung** durch drehbares Klemmelement. Somit in fast allen Lagen verwendbar.

**Nr. 500 109** Zange für Clic-Schellen drehbar  
Code: OE460000046

**Nr. 500 109/Promo** 6 Zangen im Display  
Code: OE248000248



**Turnable gripping piece** guarantees universal use. Useable in nearly all cases.

**Nr. 500 109** Plier for hose clic clamp  
Code: OE460000046

**Nr. 500 109/Promo** 6 Pliers in a display  
Code: OE248000248



**Nr. 500 109**

**Nr. 500 109/Promo**

## SCHLAUCHKLEMMZANGE FÜR CLIC-SCELLEN HOSE CLAMP PLIER FOR HOSE CLIC CLAMPS



**Zum Öffnen und Schließen** der „Clic-R“ Schlauchschellen.

**Nr. 500 110** Schlauchklemmzange für Clic-Schellen  
Code: OE460000046



**To open and close** the "Clic-R" hose clamps.

**Nr. 500 110** Hose clamp plier for hose clic clamps  
Code: OE460000046



**Anwendungsbeispiel:**  
Clic-Schelle am Dieselfilter  
Mercedes W211

Example of use:  
Hose clic clamp diesel filter  
Mercedes W211



## VAKUUM-KÜHLER-FÜLLGERÄT VACUUM COOLING SYSTEM FILLER



<b>MÜLLER-WERKZEUG</b> Technische Daten / technical information		
<b>Luftverbrauch / air consumption</b>	l/min	max. 180 bei 690 kPa
<b>Unterdruck / vacuum</b>	bar	0,85 bei 690 kPa
<b>Anschlüsse / nipple thread</b>	zoll	1/4"
<b>Schlauchlänge / tube length</b>	m	1,5



**Entfernt während des Füllens Luftblasen** mittels Vakuum. Macht eine Reinigung des Kühlsystems überflüssig. Verkürzt beträchtlich die Dauer des Füllens. Testet automatisch die Dichtheit des Systems. Vermeidet Verschwendung und Überlaufen von Flüssigkeit. Konischer Universaladapter für die meisten Kühler und Kühlflüssigkeitstanks. Keine zusätzlichen Adapter erforderlich. Schnell und einfach im Gebrauch. Verriegelbarer Druckluftknopf. Integriertes Unterdruckmanometer.

### Nr. 501 700 Vakuum-Kühler Füllgerät

Code: OE199000199



**Innovative and universally useable tool.** Quickly, professionally and effectively. By creating a vacuum at the cooling system the new cooling liquid will be sucked into the cooling system. During vacuum generation the system will be also checked for leaks. No extra adapters needed. Integrated vacuum gauge.

### Vacuum cooling system filler

## GEWINDE-REPARATUR-SATZ THREAD REPAIR KIT



### Gewinde-Büchsen, VPE 10 Stk.

Thread inserts, 10 pcs.



	Nr.	Code
<b>M5</b>	<b>505 105</b>	OE162001620
<b>M6</b>	<b>505 106</b>	OE188001880
<b>M8</b>	<b>505 108</b>	OE231002310
<b>M10</b>	<b>505 110</b>	OE253002530



**Universelles Erneuerungswerkzeug** mit Büchsen, welche sich das erforderliche neue Gewinde durch die angebrachten Schlitze selbst schneiden. Für fast alle Materialien wie z.B. Alu, Stahl, Kunststoff, Gusseisen etc.

### Nr. 505 000 Gewinde-Reparatur-Satz M5, M6, M8+ M10

Code: OE198000198



**Universally useable thread restore system.** Based on the slots the thread inserts are self-cutting. Works on nearly all materials as steel, aluminium, castings, plastics. 3-fluted special drill for exact holes.

### Thread repair system MS, M6, M8 + M10

## GEWINDE-REPARATUR-SATZ THREAD REPAIR KIT



**Universelles Erneuerungswerkzeug** mit Büchsen, welche sich das erforderliche neue Gewinde durch die angebrachten Schlitzte selbst schneiden. Für fast alle Materialien wie z.B. Alu, Stahl, Kunststoff, Gusseisen, etc.



**Universally useable thread restore system.** Based on the slots the thread inserts are self-cutting. Works on nearly all materials as steel, aluminium, castings, plastics. 3-fluted special drill for exact holes.

### Gewinde-Reparatur-Werkzeug Thread Repair Kit

Nr. 505 004 M4 Code: OE420000042	Nr. 505 008 M8 Code: OE940000094	Nr. 505 016 M16 Code: OE140000140	Nr. 505 208 M8x1 Code: OE940000094	Nr. 505 412 M14x1,25 Code: OE135000135
Nr. 505 005 M5 Code: OE680000068	Nr. 505 010 M10 Code: OE104000104	Nr. 505 018 M18 Code: OE198000198	Nr. 505 210 M10x1,25 Code: OE138000138	Nr. 505 214 M14x1,5 Code: OE135000135
Nr. 505 006 M6 Code: OE780000078	Nr. 505 012 M12 Code: OE122000122		Nr. 505 812 M12x1,25 Code: OE122000122	Nr. 505 216 M16x1,5 Code: OE140000140
Nr. 505 007 M7 Code: OE940000094	Nr. 505 014 M14 Code: OE135000135		Nr. 505 212 M12x1,5 Code: OE122000122	Nr. 505 218/L M18x1,5 Code: OE980000098

### Ersatz-Büchsen VPE 10 Stk. Thread inserts, 10 pcs. packed

Nr. 505 104 M4	Nr. 505 108 M8	Nr. 505 116 M16	Nr. 505 308 M8x1	Nr. 505 414 M14x1,25
Nr. 505 105 M5	Nr. 505 110 M10	Nr. 505 319 M18	Nr. 505 310 M10x1,25	Nr. 505 314 M14x1,5
Nr. 505 106 M6	Nr. 505 112 M12		Nr. 505 313 M12x1,25	Nr. 505 316 M16x1,5
Nr. 505 107 M7	Nr. 505 114 M14		Nr. 505 312 M12x1,5	Nr. 505 318/L M18x1,5

## REPARATURSATZ FÜR INJEKTOREN-SPANNSCHRAUBE M6 + M7 INJECTOR BOLT REPAIR KIT M6 + M7

z.B. für MB OM646, OM646 EVO, 2,0HDI und 2,0 JDT Motoren

### Ersatz-Büchsen

VPE 10 Stk.

Thread inserts,  
10 pcs. packed

Nr. 505 106 M6
Nr. 505 107 M7

### Selbstschneidende Gewindebüchsen

Thread inserts are self cutting



### 3-schneidiger Spezialaufbohrer, TIN-beschichtet

3-fluted special drill, TIN coated



### Eindrehwerkzeug

Insert setter



**Gewinde Reparatur Satz für die Befestigungsschraube** M6 / M7 von Bosch / Delphi Injektoren (z.B. DB CDI Motoren). Wird speziell benötigt, um bei abgerissenem bzw. defektem Innengewinde im Alu-Zylinderkopf eine neue, hochfeste Gewindebüchse über der abgerissenen Schraube einzusetzen.

**Nr. 505 006/MB Reparatursatz für Injektoren-Spannschraube M6**  
Code: OE112000112

**Nr. 505 007/MB Reparatursatz für Injektoren-Spannschraube M7**  
Code: OE148000148



**Thread repair kit for the fixing bolt** M6 / M7 of BOSCH/ Delphi injectors (e.g. DB CDI engines). Needed to install the new insert above the broken original bolt.

**Injector bolt repair set M6**

**Injector bolt repair set M7**



**Gewindebohrer XL**  
**für Injektoren-Spannschraube**  
Special tap XL for injector screw

## LAMBDA-SONDEN-REPARATUR-SATZ REPAIR KIT FOR OXYGEN SENSOR



Zur Reparatur von beschädigten Lambdasonden-gewinden M18 x 1,5. Lieferung komplett mit 5 Gewinde-Büchsen im Holzkasten.

**Nr. 505 218 Lambdasonden-Reparatur-Satz**

Code: OE118000118



To repair the damaged inside thread for oxygen sensors. Shipment includes wooden box.

**Nr. 505 218 Repair kit for oxygen sensor**

Code: OE118000118



**Eindrehwerkzeug**  
Insert setter



**3-schneidiger Spezialaufbohrer, TIN-beschichtet**  
3-fluted special drill, TIN-coated



**Selbstschneidende Gewindebüchsen**  
Thread inserts are self cutting

## LAMBDA-SONDENSCHLÜSSEL OXYGEN SENSOR SOCKET



**Bewährter Spezialschlüssel** zur De- und Montage der Lambdasonde am Auspuffkrümmer. Seitlich geschlitzt zur Durchführung des Kabels. 1/2" Antrieb, Sonderstahl, brünierte Ausführung.

**Nr. 506 318 Lambdasondenschlüssel**

Code: OE348003480

**Seitlich geschlitzt zur Durchführung des Kabels**  
One side slotted for the cable



**Special tool to remove and install the oxygen sensor** at the exhaust manifold. 1 side slotted for the cable. Special steel. 1/2" square.

**Oxygen sensor socket**

## MOTOR-BRÜCKE ENGINE HANGER

**Standbreite: 1100 - 1570 mm**  
Stand width: 1100 - 1570mm



**Spindelhub: 400mm**  
Spindle lift: 400 mm



**Unentbehrlich zum Halten und Heben** von Motoren. Massive und verzinkte Ausführung mit drehbaren, schräg-stehenden Standfüßen. Dadurch auch diagonale Anwendung (siehe Foto) möglich. Keine Lackbeschädigung durch Standfüße mit Gummieinsätzen. Lieferung komplett mit 2 Hubspindeln und Karabinerhaken.

**Nr. 510 001 Motor-Brücke**

Code: OE298000298



**Needed to lift and hold the engine.** Strong and zinc plated construction with turnable and slanted feet. Based on that also a diagonal use is possible. Rubber pads on feet to avoid paint damage. Includes 2 lifting spindles with bearings and hooks.

**Engine hanger**

## UNIVERSAL-MOTOR-STÜTZTRAVERSE UNIVERSAL ENGINE SUPPORT



### Flexibel gelagerter Stützteller

The inner plate is supported



### Handrad zur Höhenverstellung

Handle for level adjustment



**Universal Motor Abstützvorrichtung.** Zur sicheren Demontage / Montage der Motor- und Getriebeaufhängung bei Zahnriemenwechsel. Verwindungsfrei durch Doppel-Vierkantprofil. Flexibel gelagerter Stützteller mit rutschfester Gummiauflage. Absolut universelle Anwendung!

**Nr. EQ-510 012 Universal-Motor-Stütztraverse**  
Code: OE398000398



**Universal engine support device.** For safe disassembly of the motor suspension (engine support). The support is attached directly to the vehicle cross member.

**Universal engine support**

## UNIVERSAL-MOTOR-STÜTZVORRICHTUNG UNIVERSAL ENGINE SUPPORT



**Universal Motor Abstützvorrichtung.** Zur sicheren Demontage / Montage der Motor- und Getriebeaufhängung bei Zahnriemenwechsel. Verwindungsfrei durch Doppel-Vierkantprofil. Flexibel gelagerter Stützteller mit rutschfester Gummiauflage. Absolut universelle Anwendung!

**Nr. EQ-510 013 Universal-Motor-Stützvorrichtung**  
Code: OE348000348



**Universal engine support device.** For safe disassembly of the motor suspension (engine support). The support is attached directly to the vehicle cross member.

**Universal engine support**



## DIESELFILTER-FÜLLGERÄT V2 DIESEL FILTER FILLER V2



Zum schnellen, sauberen und problemlosen Entlüften (Befüllen) der Dieselfilter sämtlicher Fahrzeuge. Beim Filterwechsel, leergefahrenem Tank, falsch getankt...

Mit Betätigung des Hebels wird ein Vakuum im Dieselfilter-Füllgerät erzeugt. Dieses Vakuum wird durch die Spezialschläuche an den Dieselfilter "weitergegeben". Somit wird vom Tank her der Kraftstoff angesaugt. **Ergonomische Entleerung, integriertes Vakuum-Manometer. Vakuumstärke stufenlos regulierbar.** Durch die verschiedenen Schläuche universell passend.

**Anschluss am Vorlauf, vom Dieselfilter zum Motor.**

### Nr. 515 007/V2 Dieselfilter-Füllgerät

Code: OE158000158

Nr. 515 007/4

Code: OE680000068

Schlauchsoriment für Dieselfilter-Füllgerät, 4-tlg.



**Especially for quick, clean and problem free bleeding of diesel filter** (filling of the diesel filter).

Universally for all cars diesel filter changing, as for empty driven tank. Different hoses guarantee universal fitting. Connect at the line diesel to engine.

### Diesel filter filler

Silicone hose kit for diesel filter filler, 4 pcs.

## SCHLAUCHKLEMM-SET HOSE CLAMP KIT



**Langjährig bewährtes Spezialwerkzeug** zum Abklemmen von Schläuchen aller Art. Universell einsetzbar, z.B. Kraftstoff, Kühler, Wischwasser etc. Hochwertige Ausführung mit integrierter Messing-Gewindebüchse im Drehgriff. Je 2 Stk. für Schläuche bis Ø 10, 25 und 45 mm.

### Nr. 546 006 Schlauchklemmen-Set, 6-tlg.

Code: OE490000049



**Special tool for the clamping of all kinds of hoses**, tried and tested for many years. E.g. fuel, coolant, wiping water, etc. High-quality design with integrated brass threaded bushing in the turning handle. 2 pcs. each for hoses to 10, 25 and 45 mm.

### Nr. 546 006 Hose clamp kit, 6 pcs.

Code: OE490000049



max Ø 25mm

max Ø 10mm

max Ø 45mm

**Alle Teile einzeln erhältlich**

All parts separately available

	Nr.	Code
<b>10mm</b>	<b>546 001</b>	OE100000010
<b>25mm</b>	<b>546 003</b>	OE150000015
<b>45mm</b>	<b>546 004</b>	OE190000019

## MOTORÖL-FÜLLTRICHTER MOTOR-OIL FUNNEL



**Motoröl sauber und professionell Einfüllen.** Keine Wartezeiten durch langwieriges Einlaufen des Motoröls in den Motor. Keine Motorverunreinigung durch daneben laufendes Motoröl.

Spezial-Trichter mit 4-Finger Renkverschluss zur direkten und dichten Verbindung mit der Öl-Einfüllöffnung am Motor. Made in Germany. 2,3 Liter Fassungsvermögen.

Universell passend, u.a. für AUDI A5 Cabrio, A3 ab 10.2012, VW Bora, Golf 7 + Polo ab 11/2012, SEAT Leon, Skoda Octavia ab 11/2012  
Motoren: z.B. 1,6l 1,8l und 2,0l mit Steuerkette  
Motorcodes: CFKB, CUDA, CHHB, CLSA, CLZB, CLHA, CLHB

**Nr. 556 000 Motoröl-Fülltrichter**  
Code: OE45000045 mit Bajonettverschluss

**Nr. 556 006 Motoröl-Fülltrichter**  
Code: OE78000078 z. B. Golf 7 etc.



**Made for filling the motor oil.** Quick coupling for a direct and sealed connection. Fits universally for Audi, VW, SEAT, SKODA, DB etc.

**Motor-oil funnel**  
with Quick Coupling

**Motor-oil funnel**  
e. g. Golf 7 etc.



**Bajonettverschluss**  
Quick coupling

## FLUID CONTROLLER



**Flexibler Trichter zum einfachen und sauberen Ablassen** sämtlicher Flüssigkeiten, z.B. Benzin, Diesel, Motor-, Getriebe- und Hydraulik-Öl, Bremsflüssigkeit, Kühlflüssigkeit etc. Einfache Reinigung des Trichters. Bis 220°C hitzebeständig. Zwei unterschiedliche Größen.

**Nr. 556 040 Fluid controller Typ 1, 370 x 170mm**  
Code: OE298002980

**Nr. 556 050 Fluid controller Typ 2, 410 x 200mm**  
Code: OE390000390



**Flexible funnel for the easy fill in & out of any kind of fluids**, e.g. Motor-oil, gearbox-oil cooling water etc. Heat resistant.

**Fluid controller type 1, 370 x 170mm**

**Fluid controller type 2, 410 x 200mm**



**Nr. 556 040 Typ 1, 370 x 170mm**



**Nr. 556 050 Typ 2, 410 x 200mm**



## SPEZIALSCHLÜSSEL FÜR MOTORRAUM ENGINE + TIMING BELT WRENCH



**Spezialschlüssel SW13, 15, 16, 17 + 19.**  
Für schwer zu erreichende Stellen im Motorraum,  
z. B. Lösen und Spannen des Flachriemens.

**Nr. 570 600 Spezialschlüssel für  
Motorraum**  
Code: OE118000118



**Engine + timing belt wrench 13, 15, 16,  
17 + 19mm.** For hard to reach areas, e.g. loo-  
sen and clamping of flat belt.

**Nr. 570 600 Engine + timing belt  
wrench**  
Code: OE118000118



**SW13, 15, 16, 17 + 19**  
13, 15, 16, 17 + 19mm

## ABZIEHER FÜR INJEKTOR-KUPFER-DICHTRING REMOVER FOR INJECTOR COPPER SEAL



**Spezialwerkzeug zur Demontage der Injektoren  
Kupfer-Dichtringe** im Zylinderkopf. Extrem festsitzende  
Kupfer-Dichtringe lassen sich hiermit zeitsparend ausziehen.

**Nr. 600 105 Abzieher für  
Injektor-Kupfer-Dichtring**  
Code: OE899008990



**Special tool for demounting the copper seal ring** of  
the injectors. Extremely tightened copper seals can be pulled  
easy with this tool.

**Nr. 600 105 Remover for  
injector copper seal**  
Code: OE899008990

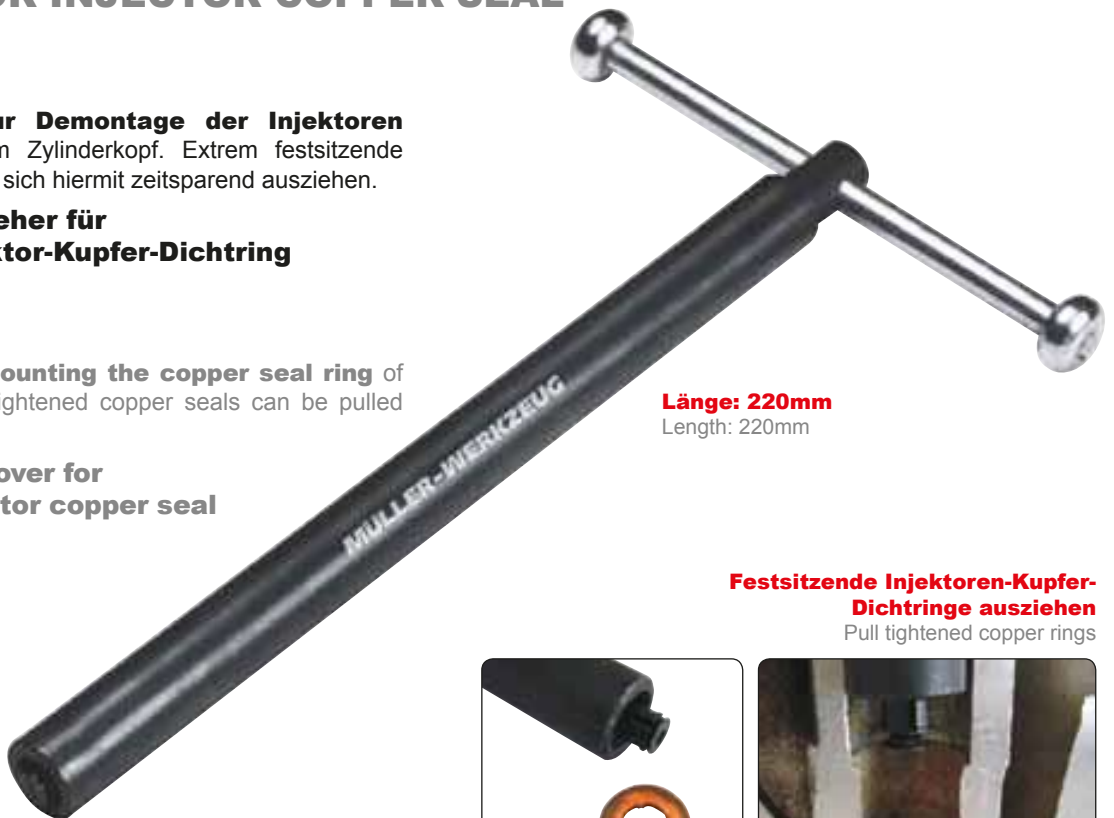

**Länge: 220mm**  
Length: 220mm

**Festsitzende Injektoren-Kupfer-  
Dichtringe ausziehen**  
Pull tightened copper rings



## DICHTSITZREINIGER FÜR DIESELINJEKTOREN REAMER KIT FOR INJECTOR SEAT

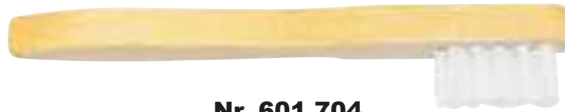

**Nr. 601 704**  
Code: OE390000390



**Nr. 600 110**  
Code: OE690000069



**Nr. 456 180/K**  
Code: OE280000028



**Spezialfräser für den Dichtsitz am Injektor**  
Special reamer for the injector seat



**Nr. 600 115 (Typ 1)**      **Nr. 600 115/2 (Typ 2)**  
Code: OE118000118      Code: OE128000128

**Spezialfräser für den Dichtsitz im Zylinderkopf**  
Special reamer for the injector seat in the cylinderhead



**Spezialfräser zur Reinigung des Dichtsitzes** der Dieselinjektoren. Z. B. Mercedes CDI Motoren, Bosch / Delphi Injektoren (BMW, RENAULT, FORD, FIAT, IVECO) Common Rail Dieseleinspritzsystem. Typ 2 für neuen Motorentyp, z.B. 2,0 HOi + 2,0 JTD, MB OM646 EVO.

**Nr. 600 111 Universal Dichtsitzreiniger Typ 1**  
Code: OE208000208  
MB CDI: OM611, OM612, OM613, OM639, OM640, OM642, OM646, OM647, OM648, OM668  
Smart: R660  
Lexus: 2.2 Diesel, 2 AD-FHV  
Toyota: 2.2 + 3.0 D-4D, 2 AD-FHV, 2 AD-FTV / 1 KD-FTV  
Chrysler: 2.5 CRD, OM664

**Nr. 600 114 Universal Dichtsitzreiniger Typ 2**  
Code: OE218000218  
MB: OM646 EVO,  
Peugeot, Lancia, Fiat, Citroen, Suzuki 2,0HDI und 2,0 JTD  
Nissan, Opel, Renault 2.2 + 2.5 DTI, CDTI, G9T / G9U



**Special reamer to clean the seal seat** of the diesel-injectors e.g. Mercedes CDI engines, Bosch / Delphi injectors (BMW, RENAULT, FORD, FIAT, IVECO) Common Rail Diesel fuel injection. Type 2 for e.g. 2,0 HOi + 2,0 JTD, MB OM646 EVO.

**Universal reamer kit type 1**  
MB CDI: OM611, OM612, OM613, OM639, OM640, OM642, OM646, OM647, OM648, OM668  
Smart: R660  
Lexus: 2.2 Diesel, 2 AD-FHV  
Toyota: 2.2 + 3.0 D-4D, 2 AD-FHV, 2 AD-FTV / 1 KD-FTV  
Chrysler: 2.5 CRD, OM664

**Universal reamer kit type 2**  
MB: OM646 EVO,  
Peugeot, Lancia, Fiat, Citroen, Suzuki 2,0HDI und 2,0 JTD  
Nissan, Opel, Renault 2.2 + 2.5 DTI, CDTI, G9T / G9U

## UNIVERSAL DICHTSITZREINIGER UNIVERSAL SEAL SEAT CLEANER

**Reinigungsfräser für Injektor - Dichtsitz im Zylinderkopf:**  
**15mm (Universelle Anwendung), 17mm (Delphi und Bosch Injektoren), 19mm (Bosch Injektoren, z.B. MB CRD), 19mm konisch (Iveco + Fiat)**

Injector seat cleaner for the cylinder head:  
15mm (universal application), 17mm (Delphi + Bosch injectors),  
19mm (Bosch injectors, e.g. MB CRD), 19mm angled (IVECO + Fiat)



**Spezialfräser zur Reinigung des Dichtsitzes** der Dieselinjektoren. z.B. Mercedes CDI Motoren, Bosch / Delphi Injektoren (BMW, RENAULT, FORD, FIAT, IVECO) Common Rail Dieseleinspritzsystem.

**Nr. 600 116 Universal Dichtsitzreiniger**

Code: OE298000298



**Special reamer to clean the seal seat** of the diesel injectors e.g. Mercedes CDI engines, Bosch / Delphi injectors (BMW, RENAULT, FORD, FIAT, IVECO) Common Rail Diesel fuel injection.

**Nr. 600 116 Universal seal seat cleaner**

Code: OE298000298



**Zur Reinigung des Dichtsitzes im Zylinderkopf.**  
To clean the seal seat in the cylinder head.



**Kurze Ausführung mit Bohrung für Dichtsitz am Injektor.**  
Short version to clean the injector-seal seat.

## INJEKTOREN-AUSZIEHVORRICHTUNG INJECTOR EXTRACTOR



**Spezial Schlagauszieher für Injektoren.** Gewölbte Auflagefläche an den Greifhaken, für exakt mittiges und zentrisches Ansetzen der Abziehkraft. Somit kein Verkanten des Injektors im Schacht. Greifkopf und Schlaggewicht auch separat verwendbar.

**Nr. 600 120 Injektoren-Auszehvorrichtung**

Code: OE108000108



**Special slide hammer puller.** Curved contact area to center the impact of the slide hammer. Puller and slide hammer are available also separately.

**Nr. 600 120 Injector extractor**

Code: OE108000108



**Nr. 600 120-1**

Code: OE680000068



**Nr. 600 121**

Code: OE360000036



**Gewölbte Auflagefläche für exakt mittiges und zentrisches Ansetzen der Abziehkraft**  
Curved contact area to center the impact of the slide hammer

## SCHLAGHAMMER FÜR INJEKTOREN SLIDE HAMMER FOR INJECTORS



**Injektoren-Ausziehsatz mit 6 + 3kg Schlaggewicht** für extrem festsitzende Injektoren. Einschraubadapter M 17x1 und Spezialstecknuss mit Bohrung 10mm x 1/2" zum Zerlegen des Injektors.

### Nr. 600 122 Schlagauszieher für Injektoren

Code: OE348000348



**Injector extraction kit with 6+3kg impact weight** for very tight injectors. Screw-in adapter M17x1 and special socket with hole 10mm x 1/2" for disassembling the injector.

### Nr. 600 122 Slide hammer for injectors

Code: OE348000348

### Adapter für vorhandene Schlaggewichte A:M20x1,5

Adapter for existing impact weight A:M20x1,5



	Nr.	Code
<b>I:M16</b>	<b>433 450/46</b>	OE380000038
<b>I:M18</b>	<b>433 450/48</b>	OE380000038
<b>I:M18x1,5</b>	<b>433 450/49</b>	OE380000038
<b>I:M20</b>	<b>433 450/50</b>	OE380000038

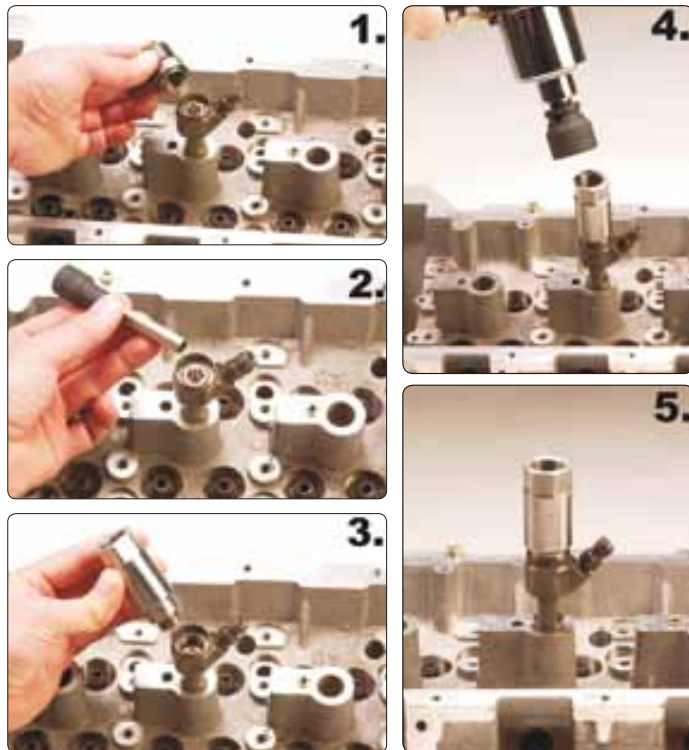

**Lieferumfang:**  
**Universal Gleithammer extra schwer, Adapter für Bosch-Injektoren, Adapter für Delphi-Injektoren, Spezialstecknuss mit Bohrung 10mm x 1/2"**

Shipment incl.:  
Universal slide hammer extra heavy, adapter for Bosch-injectors, adapter for Delphi-injectors, special socket with hole 10mm x 1/2"



## VIBRO-IMPACT®



### Alle Teile einzeln erhältlich

All parts separately available



Nr. 433 450

**Spezialstecknuss**  
**Special socket**  
Nr. 600 122-2  
Code: OE248002480

**BOSCH-Adapter**  
Nr. 600 122-1  
Code: OE740000074

**DELPHI-Adapter**  
Nr. 600 122-3  
Code: OE580000058

# VIBRO-IMPACT® INJEKTOREN-ZUG EINHEIT

## VIBRO-IMPACT® INJECTOR-PULL UNIT

### VIBRO-IMPACT®

**Alle Teile einzeln erhältlich**  
All parts separately available



**VIBRO-IMPACT®  
Drucklufthammer  
Air Hammer  
Nr. 290 200**  
Code: OE248000248



**Spezialstecknuss  
Special socket  
Nr. 600 122-2**  
Code: OE248000248



**BOSCH-Adapter  
Nr. 600 122-1**  
Code: OE740000074



**DELPHI-Adapter  
Nr. 600 122-3**  
Code: OE580000058



**Zug einheit  
Pull-unit  
Nr. 600 125**  
Code: OE248000248

**Nr. 600 128**  
**Lieferumfang: Zug einheit  
inkl. Drucklufthammer  
und Injektorenadapter**  
Shipment: Pull unit incl. injector-  
adapter and air hammer

**Aufnahmeadapter:  
10,2mm**  
Adapter for air hammer:  
10,2mm

**Aufnahmeadapter für  
Injektoren-Adapter:  
M20x1,5**  
Adapter for injector-adapter:  
M20x1,5



**VIBRO-IMPACT®** Zug einheit zur Anwendung mit dem Drucklufthammer. Festsitzende Injektoren können schnell, sicher und einfach mittels **VIBRO-IMPACT®** gelöst und herausgezogen werden.

**Nr. 600 127** **VIBRO-IMPACT® Zug einheit inkl. Adapter**  
Code: OE3780000378

**Nr. 600 128** **VIBRO-IMPACT® Zug einheit inkl. Drucklufthammer und Adapter**  
Code: OE5580000558



**VIBRO-IMPACT®** pull unit for the safe and easy pulling of injectors. **VIBRO-IMPACT®** helps to disassemble very tight injectors.

**VIBRO-IMPACT® pull unit incl. adapter**

**VIBRO-IMPACT® pull unit incl. air hammer and adapter**

## SPANNPLATTEN FÜR INJEKTOREN CLAMPING PLATES FOR INJECTORS



**Spannbereich:**  
**11,1mm, 12,1mm, 13,1mm + 19,1mm**  
Clamping range:  
11,1mm, 12,1mm, 13,1mm, 19,1mm

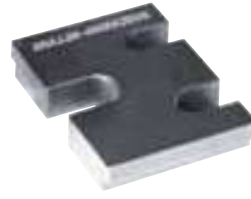

**Spannbereich:**  
**14,3mm, 16,3mm + 20,3mm**  
Clamping range:  
14,3mm, 16,3mm + 20,3mm

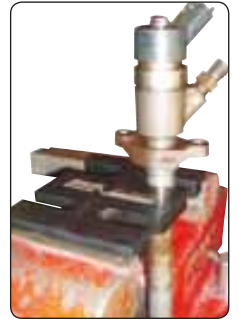

**Spannplatte wird im Schraubstock fixiert** und sorgt bei Zerlegung des Injektors für einen stabilen und sicheren Sitz. 2-tlg. Für Bosch, Delphi und Siemens Injektoren. Satz bestehend aus: Spannplatte 1: 14,3 mm; 16,3 mm; 20,3 mm. Spannplatte 2: 11,1 mm; 12,1 mm; 13,1 mm; 19,1 mm.

**Nr. 600 140 Spannplatten für Injektoren, 2-tlg.**  
Code: OE118000118



**Fix the plate at the workbench vise.** For disassembling the injector it guarantees a strong and save position. Diameters clamping plate 1: 14,3mm, 16,3mm and 20,3mm. Clamping plate 2: 11,1mm, 12,1mm, 13,1mm and 19,1mm.

**Clamping plate for injectors, 2 pcs.**

## INJEKTOREN-STECKNUSS-SATZ INJECTOR SOCKET KIT



**4-tlg. Satz, 25, 27, 29 + 30mm x 1/2"**  
4 pcs. Kit, 25, 27, 29 + 30mm x 1/2"



**Injektoren-Stecknuss-Satz zum einfachen und beschädigungsfreien Demontieren** der Elektronikeinheit an Diesel Injektoren.

**Nr. 600 150 Injektoren-Stecknuss-Satz, 4-tlg.**  
Code: OE232000232

**25mm**

**Siemens Injektoren, 2.0 HDI PSA, Toyota, Ford etc.**

**27mm**

**Siemens Piezo Injektoren 2.0 HDI Piezo**

**29mm**

**Bosch Injektoren, CDI / HDI**

**30mm**

**Bosch Injektoren, Renault + Nissan**

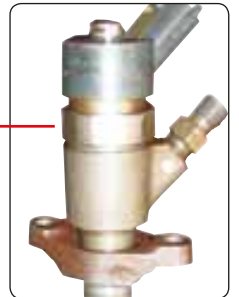

**Injector-socket kit for the easy and damage free removal** of the electrical solenoid of diesel injectors.

**Injector socket kit, 4 pcs.**

## ABDREHER FÜR GLÜHKERZENELEKTRODE GLOW PLUG EXTRACTOR KIT



**Glühkerzen-Mittелеlektroden Abdreher-Satz 6-tlg.** Für Glühkerzen M8, M9, M10 und M12. linksdrehende Spezialstecknüsse. Lieferung auf Stecknussleiste.

**Nr. 600 206 Abdreher für Glühkerzenelektroden**  
Code: OE128000128



**Extractor kit for the core element of the glow plug, 6 pcs.** For all glow plugs, M8, M9, M10 and M12. Special left drill sockets. Shipment includes socket-rail.

**Nr. 600 206 Glow plug extractor kit**  
Code: OE128000128



**2,60, 3,20, 3,50, 4,50, 6,50, 8,25mm**



## UNIVERSAL AUSBOHRSATZ FÜR GLÜHSTIFTE UNIVERSAL DRILL KIT FOR GLOW PLUG

### Abdreher für Glühkerzenelektrode

Glow plug extractor

### 3-schneidiger, linksschneidender Stufenbohrer, TIN-beschichtet

3-edged, left-cutting step drill, TIN-coated

### Gewindebohrer, TIN-beschichtet

Tap for the extractor, TIN-coated

### Glühkerzengewindebohrer, TIN-beschichtet

Tap for the glow plug thread, TIN-coated

### Ausziehadapter

Adapter for extraction



**Universal-Glühkerzen Ausbohr-Werkzeug** mit neuartigem Prinzip. Der 3-schneidige selbstzentrierende, linksschneidende Spezial - Stufenbohrer benötigt keine spezielle Bohrhülse wie alle anderen, uns bekannten Ausbohrwerkzeuge.

#### Nr. 600 240 Ausbohrsatz für Glühstifte M10 x 1

Code: OE308000308

#### Nr. 600 242 Ausbohrsatz für Glühstifte M12 x 1,25

Code: OE308000308

#### Nr. 600 245 Ausbohrsatz für Glühstifte M10 x 1,25

Code: OE328000328

#### Nr. 600 248 Ausbohrsatz für Glühstifte M8 x 1

Code: OE308000308

#### Nr. 600 249 Ausbohrsatz für Glühstifte M9 x 1

Code: OE328000328



**A set of special drills and taps** for the safe and effective removal of broken / damaged glow plugs. Each set contains precision engineered components to allow the removal of broken parts, without damaging the engine, and leaving a clean cut thread for the fitting of the new part.

#### Drill kit for glow plugs M10 x 1

#### Drill kit for glow plugs M12 x 1,25

#### Drill kit for glow plugs M10 x 1,25

#### Drill kit for glow plugs M8 x 1

#### Drill kit for glow plugs M9 x 1

## GLÜHKERZEN REIBAHLE M8 + M10 GLOW PLUG REAMER M8 + M10

**Achtung: Nur zum Reinigen verwenden!**  
Attention: Only use for cleaning!



**Länge: 220mm**  
Length: 220mm



**Spezial Reibahle zum Reinigen des Glühkerzen-Dichtsitzes** und der kompletten Glühkerzenbohrung im Zylinderkopf. Passend z.B. für DB GDI-Motoren-Glühstifte M8 + M10

**Nr. 600 250 Glühkerzen-Reibahle M10**  
Code: OE108000108

**Nr. 600 258 Glühkerzen-Reibahle M8**  
Code: OE128000128



**Special reamer to clean the glow plug seal seat** and the complete drilling inside the cylinder head. Fits for e.g. DB GDI-engine-glow plug M8 + M10.

**Glow plug reamer M10**

**Glow plug reamer M8**



**für DB GDI-Motoren-Glühstifte M8 + M10.**  
Use for glow plug M8 + M10 of DB GDI-engine

**Glühkerzen-Dichtsitz**  
Glow plug seal seat

## DRUCKLUFT-WINKELBOHRMASCHINE RECHTS- + LINKSLAUF AIR ANGLE DRILL LEFT + RIGHT SWITCH



**Rechts- / Linksumschaltung und stufenloser Drehzahlregler**  
Left + right switch plus variable speed



**Stufenloser Abzug ermöglicht die Arbeit mit sehr geringer Drehzahl.**  
Variable speed trigger provides to work on low-rotation speed.



**Universelle Anwendung** an schwer zugänglichen Stellen. Rechts- und Linkslauf. Stufenloser Abzug. Ideal für Arbeiten mit sehr niedriger Drehzahl-Voraussetzung (z. B. Glühkerzen ausbohren). Präzisions-Bohrfutter von 0 bis 10mm. Auch als Antrieb für Schleifscheiben geeignet.

**Nr. 290 444 Druckluft-Winkelbohrmaschine**  
Code: OE238000238

Rechts- + Linkslauf. Stufenlose Drehzahlreglung.



**Universal use** on narrow space areas. Ergonomic handle. Variable speed. Left / right switch. Cool insulated based on 2-component housing. Fits also for grinding discs. Drill chuck 0-10mm included.

**Air angle drill**  
left + right switch

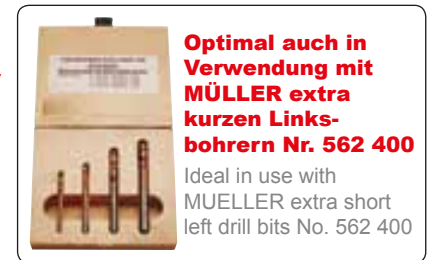

**Optimal auch in Verwendung mit MÜLLER extra kurzen Linksbohrern Nr. 562 400**

Ideal in use with MUELLER extra short left drill bits No. 562 400

MÜLLER-WERKZEUG Technische Daten / technical information		
Bohrfutter / drive	Zoll	3/8"
Gewicht / weight	Kg	1,20
Länge / length	mm	225
Anschlussgewinde / air nipple	Zoll	1/4"
Schlauchanschluss / air hose	mm	9-13
Luftverbrauch / air consumption	l/min	180
Drehzahl/min / free speed	Rpm	1400
Arbeitsdruck / air pressure	bar	6,2
Geräuschpegel / sound level	dBA	76





## GLÜHKERZEN VIBRO AUSDREHER GLOW PLUG VIBRO EXTRACTOR



## VIBRO-IMPACT®

**VIBRO-IMPACT® erzeugt kontrollierten Vibrationsimpuls**

VIBRO-IMPACT® generates a controlled turn impact impulse



**Antrieb: 1/4"**  
Drive: 1/4"

**Einhand-Umschalter**  
One hand switch

**Stufenloser Abzug**  
Variable speed

**4-Stufen einstellbares Linksdrehmoment, 10/20/30/40Nm**  
Adjustable 4-stepped left hand torque, 10/20/30/40Nm

<b>MÜLLER-WERKZEUG</b> Technische Daten / technical information			
<b>Antrieb / drive</b>	Zoll	1/4"	
		Rechts / right	Links / left
<b>Max. Drehmoment / max. torque</b>	Nm	40	
<b>Gewicht / weight</b>	Kg	0,9	
<b>Anschlussgewinde / air nipple</b>	Zoll	1/4"	
<b>Schlauch / hose</b>	mm	9-13	
<b>Luftverbrauch / air consumption</b>	l/min	250	
<b>Drehzahl (leer) / speed (empty)</b>	Rpm	12.000	
<b>Arbeitsdruck / air pressure</b>	bar	6,3 (90psi)	
<b>Geräuschpegel / sound level</b>	dBA	60	
<b>Vibration / vibration</b>	m/s <sup>2</sup>	2,1	

**Für alle Glühstifte mit SW 8, 9, 10, 11 + 12**  
For all glow plugs 8, 9, 10, 11 + 12 mm



**Das Gerät erzeugt einen kontrollierten Dreh-Schlag-impuls.** Original VIBRO-IMPACT®. Durch ein in 4 Stufen einstellbares Linksdrehmoment kann ein Abreißen weitgehend verhindert werden. Satz bestehend aus Druckluftgerät 1/4", Stecknüsse SW 8, 9, 10, 11, 12 x 1/4", 2 Verlängerungen und 1/4" Kugelgelenk.

**Nr. 600 289 Glühkerzen Vibro-Ausdreher**  
Code: OE238000238



**The special air tool generates a controlled turn-impact impulse.** Based on the adjustable 4-stepped left hand torque, a break of the glow plug will be avoided in the most cases. Kit includes special air tool 1/4", glow plug impact sockets 8, 9, 10, 11, 12mm x 1/4", 2 suspensions and 1/4" ball joint.

**Glow plug vibro extractor**

## UNI-INJEKTOR-AUSZIEHSATZ UNI INJECTOR PULLER KIT



**Universal Satz zum Ausziehen von Diesel-Injektoren.** Passend für Bosch, Delphi, Denso, Siemens. Teilweise ohne Demontage der Elektrostecker.

**Nr. 600 130 Uni-Injektor-Ausziehsatz**

Code: OE448000448



**Universal kit for diesel injectors.** Fits for Bosch, Delphi, Denso, Siemens. Mostly without removing the electric plug.

**Uni Injector puller kit**



## GLÜHSPITZEN-AUSBOHRSATZ UNIVERSAL

### COMPLETE KIT FOR GLOW PLUGS ELECTRODE EXTRACTION



Werkzeugsatz zum Ausbohren der abgebrochenen Glühkerzenspitze.

Universell passend für M10x1, M10x1,25, M9x1, M8x1.

Enorme Zeitersparnis, Alle Werkzeuge auch einzeln erhältlich, Kann den Zylinderkopftausch verhindern.

**Nr. 600 300 Glühspitzen-Ausbohrersatz  
universal**

Code: OE648000648



Set of tools for the extraction of the glow plug tip in case of breakage or seizure inside the seat, which is otherwise impossible to remove.

Suitable for glow plugs with thread: M10x1, M10x1.25, M9x1, M8x1.

The set includes all the tools needed to safely remove the end part of the glow plug electrode without damaging the cylinder head. Our procedure saves you a considerable period of time versus the alternative of having to disassemble the head.

**Complete kit for glow plugs electrode extraction**

## PLANFRÄSVORRICHTUNG V.A.G. CRANKSHAFT MILLING TOOL V.A.G.



**Zentrierbolzen**  
Pilot

**Führungspilot**  
Guiding pilot

**Fräser für  
Planfräsvorrichtung**  
Milling cutter



**Planfräsvorrichtung für die Kurbelwellen-Stirnflächen von V.A.G. Motoren.** An der Kurbelwellen-Stirnseite wird eine exakt winkelig und plane Auflagefläche benötigt, um einen korrekten und dauerhaften Sitz des Zahnriemenrades zu gewährleisten. Z. B. für VW Passat TD, Golf TD, Vento, Jetta T4, Audi, Skoda etc.

**Nr. 601 700 Planfräsvorrichtung V.A.G.  
4 Zylinder Motoren**  
Code: OE255000255



**Crankshaft milling tool for V.A.G. engine.** At the crankshaft flank side is an exactly 90° and absolutely flat surface needed to guarantee the correct and perfect seat of the pulley. Expecially made for: VW PassatTD, Golf TD, Vento, Jetta, T4 van, Audi, Seat, Skoda etc.

**Crankshaft milling tool V.A.G. 4 cylinder**



- Zur Demontage von z. B.**
- Nockenwellenräder
  - Klimaanlage
  - Ausgleichsscheiben
  - Schwingungs- / Tilgungsscheiben
  - Wasserpumpen
  - Dieselpumpen

For demounting e.g.

- Camshaft
- Aircondition
- compensating disc
- Flywheel
- Water pump
- Diesel pump



**Universal Riemenscheibenabzieher.** Unterschiedliche Teilkreise und 9 verschiedene Greifmöglichkeiten einstellbar. Hochwertige Gewindespindel, extrem kurze Bauweise.

**Nr. 602 050 Universal  
Riemenscheibenabzieher**  
Code: OE890000089

## UNIVERSAL RIEMENSCHLEIBENABZIEHER UNIVERSAL PULLEY PULLER

**9 verschiedene Greifmöglichkeiten**  
9 different positions of the arms

**Unterschiedliche Teilkreise**  
Different devidings

**Extrem kurze Bauweise**  
Extra short design



**Different devidings for 9 positions of the arms.**  
Extra short design for limited access.

**Universal pulley puller**

## ÖLWANNEN-REPARATURSATZ OIL PAN REPAIR KIT



Bei **ausgerissenen Ölablassgewinden** musste bisher die komplette Ölwanne ausgetauscht werden. Dieses Werkzeug ermöglicht es das vorhandene, defekte Gewinde in seinem Durchmesser zu vergrößern. Eine neue, mitgelieferte Ablassschraube kann eingesetzt werden. Lieferung mit je 10 Spezialschrauben + Dichtungen und Gewindebohrer in Holzbox.

**Nr. 622 100 Ölwanne-Reparatursatz  
M14x1,5 auf M15x1,5**  
Code: OE880000088

**Nr. 622 600 Ölwanne-Reparatursatz  
M18x1,5 auf M20x1,5**  
Code: OE890000089



Until now, the complete oil pan always had to be replaced when the oil drain screw was torn. This tool enables you to increase the diameter of the existing faulty thread and to insert the enclosed drain screws. Delivery complete with 10 each of special screws + seals, screw taps in a wooden box.

**Nr. 622 100 Oil pan repair kit  
M14x1,5 auf M15x1,5**  
Code: OE880000088

**Nr. 622 600 Oil pan repair kit  
M18x1,5 auf M20x1,5**  
Code: OE890000089



**Nr. 622 300** Ersatzschrauben mit Dichtung M15x1,5, 10 Stk.  
Code: OE420000042

**Nr. 622 610** Ersatzschrauben mit Dichtung M20x1,5, 10 Stk.  
Code: OE450000045



**Nr. 622 300** Spare screw with seals M15x1,5, 10 pcs.  
Code: OE420000042

**Nr. 622 610** Spare screw with seals M20x1,5, 10 pcs.  
Code: OE450000045

## ZÜND- UND GLÜHKERZENGEWINDE-REPARATURSATZ REPAIR KIT FOR SPARK- AND GLOW PLUGS



Zur Reparatur defekter **Zünd- und Glühkerzengewinde** durch speziell gasdichte Gewindebüchsen. Kein Herausdrehen bei späterem Zünd- und Glühkerzenwechsel. Für Zünd- und Glühkerzen mit folgenden Gewindegrößen: M8 x 1, M9 x 1, M10 x 1, M10 x 1,25, M12 x 1,25 und M14 x 1,25.

**Nr. 623 208** Glühkerzengewinde-Rep. M8x1  
Code: OE980000098

**Nr. 623 209** Glühkerzengewinde-Rep. M9x1  
Code: OE128000128

**Nr. 623 210** Glühkerzengewinde-Rep. M10x1  
Code: OE128000128

**Nr. 623 201** Glühkerzengewinde-Rep. M10x1,25  
Code: OE128000128

**Nr. 623 212** Glühkerzengewinde-Rep. M12x1,25  
Code: OE188000188

**Nr. 623 214** Zündkerzengewinde-Rep. M14x1,25  
Code: OE188000188



**Seals the combustion chamber.** Remove the old thread parts and make the new thread in one step. Tight insert connection. Thread insert will not come out, if a glow- or a spark plug exchange is needed again.

Repair kit glow plug M8x1

Repair kit glow plug M9x1

Repair kit glow plug M10x1

Repair kit glow plug M10x1,25

Repair kit glow plug M12x1,25

Repair kit spark plug M14x1,25



**Glühkerzengewinde-Reparatursatz  
M10x1, Nr. 623 210**

Repair kit for glow plug thread  
M10x1, no. 623 210

## EINSETZWERKZEUG FÜR ZÜND- UND GLÜHKERZEN SPARK AND GLOW PLUG STARTER

**Vollgummi-Ausführung**  
Flexible rubber tool.



**Zum Einsetzen von schwer zugänglichen Zünd- und Glühkerzen.**  
For hard to reach spark- and glowplugs.



**Flexibles Werkzeug aus Vollgummi.** Zum sauberen Ansetzen der ersten Gewindgänge, insbesondere bei Common-Rail Glühkerzen. Für Zünd- und Glühkerzen universell passend.

**Nr. 651 001 Einsetzwerkzeug für Zünd- und Glühkerzen**  
Code: OE98000980



Useful tool to install the first pitch of common rail glow plugs. Fits spark plugs as well. Special anti-slip textured surface for ultimate grip.

**Nr. 651 001 Spark and Glow Plug Starter**  
Code: OE98000980

## ZYLINDERKOPF- DICHTIGKEITS-PRÜFGERÄT CYLINDER HEAD TESTER



**Entdeckt sicher und rationell Risse und Lecks** an Zylinderkopf, Zylinderkopfdichtung und Motorblock. Die sich selbst regenerierende Testflüssigkeit verfärbt sich bei Undichtigkeit und gewährleistet exakte Prüfergebnisse. Lieferung komplett in Holzbox.

**Nr. 660 001 Zylinder-Dichtigkeits-Prüfgerät**  
Code: OE118000118

**Nr. 660 002 Testflüssigkeit**  
Code: OE175001750

**Nr. 660 003 Reinigungslösung**  
Code: OE120000012



**Diagnoses safely and quickly leaks, bricks** at the cylinder head and engine block. The self-recovering test liquid changes the color if there is a leak and ensures exact results. Will be supplied in wooden box.

**Cylinder head tester**

Test liquid

Cleaning liquid

## ZYLINDER-DRUCKVERLUST-TESTER CYLINDER LEAKAGE TESTER



**Zylinder Druckverlust-Tester zur professionellen Analyse** von Kompressionsverlusten. Durch einen genauen Anzeigewert kann der Kompressionsverlust lokalisiert werden.

**Nr. 660 200 Zylinder-Druckverlust-Tester**  
 Code: OE198000198



**Cylinder leakage tester gauges the amount of leakage** in an engine cylinder. It is the best use to compare a suspect cylinder.

**Cylinder leakage tester**



## 4 IN 1 REFRAKTOMETRER DEF / AD-BLUE 4-IN-1 REFRAKTOMETRER

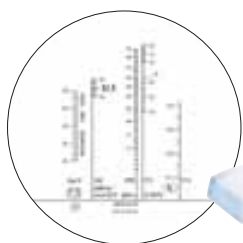

**The kit includes:**

- Refractometer.
- Soft cloth.
- Long-neck dropper.
- Screw driver (for calibration adjustment).
- Pointer.

Zum optischen Test von Ad-Blue, Kühflüssigkeit, Batteriesäure, Scheibenwischerwasser.  
 Made in Germany

**Nr. 727 090 4 in 1 Refraktometer**  
 Code: OE 980000098

**Refractometer for testing the quality** of Ad-Blue, radiator coolant, windshield washerfluid and battery acid tester. 4 scales in one tester!

**DEF / AD-Blue 4-in-1 Refractometer**

## POWER SAFE



**Verwendung bei Starthilfe, beim Laden der Batterie und bei Schweißarbeiten** an der Karosserie. Hochspannung wird schnell und zuverlässig eliminiert. Mit LED Kontroll-Leuchte. Powersafe ist in der 12 Volt PKW- und der 24 Volt LKW-Ausführung erhältlich.

**Nr. 727 200 Powersafe PKW 12V**  
 Code: OE780000078

**Nr. 727 224 Powersafe LKW 24V**  
 Code: OE660000066



**Used for assist for starting, battery charging and welding work.** Voltage peaks will be eliminated. LED shows if connected with the battery. Available for 12V + 24V.

**Nr. 727 200 Powersafe for vehicles 12V**  
 Code: OE780000078

**Nr. 727 224 Powersafe for trucks 24V**  
 Code: OE660000066



## DOPPELGELENK-ZANGENSATZ 2-JOINT PLIER KIT

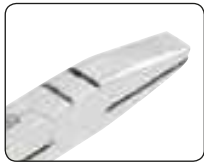

Nr. 748 201



Nr. 748 202



Nr. 748 203



Nr. 748 204



Nr. 748 205

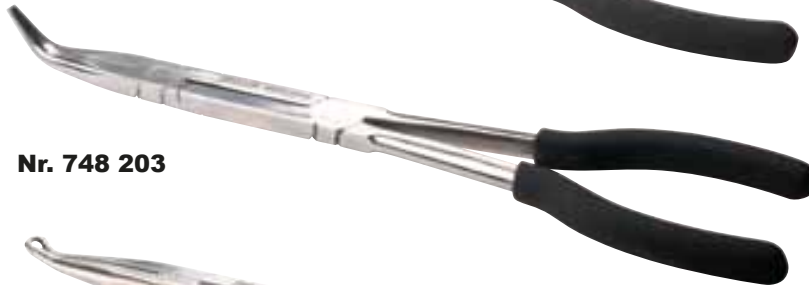

**Nr. 748 204, Typ 6mm:**  
**VW-Unterdruckschläuche**  
**z.B. am Turbolader.**  
**Universelle Anwendung**  
**für Kraftstoffleitungen**

VW-Vacuum hose at the turbo.  
Fuel line connectors.

**Nr. 748 205, Typ 12mm:**  
**VW Golf 4 obenliegendes**  
**Saugrohr. VW 1,61**  
**4 Zyl. Motor Zündkerzen-**  
**stecker. Universelle**  
**Anwendung für Heizungss-**  
**chläuche**

VW Golf 4, Air inlet tube.  
Heating system hoses.  
VW 1,61 spark plug connector.



**Die Doppelgelenk-Konstruktion ermöglicht das Arbeiten an engen und schwer zugänglichen Stellen, z.B. Stecker lösen, Kabel lösen, Kraftstoff-Leitungsverbindungen lösen.**

**Nr. 748 200/2 Zangensatz 2-tlg.**  
Code: OE870000087

Nr. 748 204, Nr. 748 205

**Nr. 748 200/3 Zangensatz 3-tlg.**  
Code: OE124000124

Nr. 748 201, Nr. 748 202,  
Nr. 748 203

**Nr. 748 200/5 Zangensatz 5-tlg.**  
Code: OE188000188

Nr. 748 201, Nr. 748 202,  
Nr. 748 203,  
Nr. 748 204, Nr. 748 205



**This double joint plier can reach also very narrow places. For example to loose electric connectors or couplings of fuel lines.**

**2-joint plier kit**  
Nr. 748 204, Nr. 748 205

**2-joint plier kit**  
Nr. 748 201, Nr. 748 202,  
Nr. 748 203

**2-joint plier kit**  
Nr. 748 201, Nr. 748 202,  
Nr. 748 203,  
Nr. 748 204, Nr. 748 205



**SPEZIAL-ZANGENSATZ "GUN TYPE"**  
**PLIER KIT "GUN TYPE"**

**Ergonomischer Griff**  
 Ergonomie handle

**Anwendungsbeispiel:**  
**Glühkerzen sicher greifen**

Example of use:  
 to grip the glow plugs



**Lieferung in praktischer**  
**Aufbewahrungsform**

Shipment includes  
 safe-keeping foam

**Nr. 748 310**



**Nr. 748 320**



**Optimale Kraftübertragung** durch Pistolengriff. Ergonomische Handhaltung durch angepassten Griff. Kraftsparendes und einfacheres Arbeiten möglich. Axiales Greifen von runden Teilen durch Spezialfräsung der Backen.

**Nr. 748 300 Spezial-Zangensatz "GUN TYPE"**  
 Code: OE68000068



**Perfect force transfer.** „Gun-type“ handle for an ergonomic use. Makes many jobs more comfortable. Based on special inner shape the gripping of small round parts is possible.

**Plier kit "GUN TYPE"**



**ÖLFILTERZANGE**  
**OIL FILTER PLIER**



**CHANNELLOCK Ölfilterzangen zum Lösen festsitzender Ölfilter.** Spezial-Zahnung. Absolut universelle Anwendung. 2-teiliger Satz bestehend aus 300 und 400mm Zange.

**Nr. CHA-OF-1 Ölfilterzange**  
 Code: OE936009360



**CHANNELLOCK oil filter plier.** Special teeth grip for perfect loosen the oilfilter. Universal application, 300 and 400mm.

**Oil Filter Plier**



Motor Engine-Tools  
 4 Zerspanung Cutting Tools  
 5 Karosserie/Verschleiß AutoBody/Consumables  
 6 Universal-Werkzeuge Universal Tools  
 7 Transporter & LKW Heavy Duty & Trucks  
 8 Equipment  
 9 Inhaltsverzeichnis Table of Contents





# ZERSPANUNG CUTTING TOOLS

**MÜLLER Tipp:**  
elektronisches Dokument  
Artikelsuche mit "Strg + F"

**MUELLER Tip:**  
electronic document  
Product Search "Ctrl + F"

**Apple:** "⌘ + F"



**REINIGUNGSSCHEIBEN-SÄTZE**   
**CLEANING DISCS KITS**

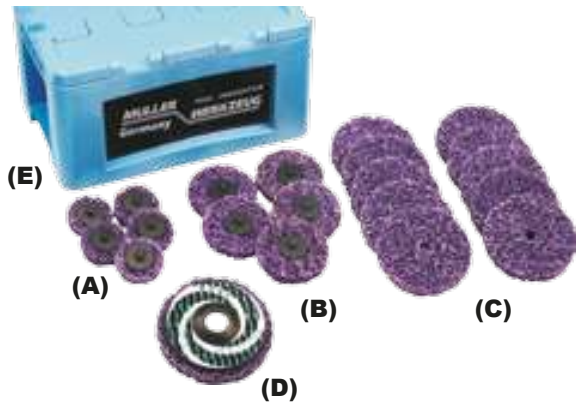

**Nr. 111 022/PUR Reinigungsscheiben-Satz, 22-tlg.**

Code: OE128000128

- 5x Reinigungsscheibe 50 x 13mm (A)
- 5x Reinigungsscheibe 75 x 13mm (B)
- 10x Reinigungsscheibe 100 x 13mm (C)
- 1x Reinigungsscheibe 115mm (D)
- 1x Aufbewahrungsbox (E)



**Nr. 111 022/PUR Cleaning discs kit, 22 pcs.**

Code: OE128000128

- 5x Cleaning disc 50 x 13mm (A)
- 5x Cleaning disc 75 x 13mm (B)
- 10x Cleaning disc 100 x 13mm (C)
- 1x Cleaning disc 115mm (D)
- 1x Box (E)

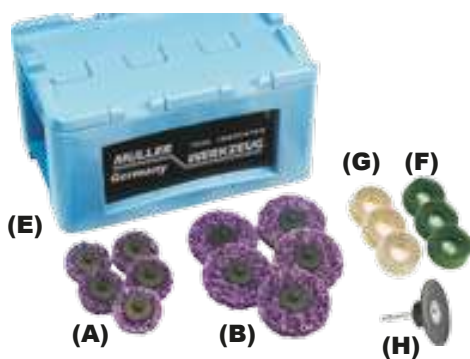

**Nr. 111 023**

Code: OE128000128

**Reinigungsscheiben-Satz, 18-tlg.**

- 5x Reinigungsscheibe 50 x 13mm (A)
- 5x Reinigungsscheibe 75 x 13mm (B)
- 3x Reinigungsbürste 50mm grün (F)
- 3x Reinigungsbürste 50mm weiß (G)
- 1x Aufnahmeschaft mit Gewinde (H)
- 1x Aufbewahrungsbox (E)



**Nr. 111 023**

Code: OE128000128

**Cleaning discs kit, 18 pcs.**

- 5x Cleaning disc 50 x 13mm (A)
- 5x Cleaning disc 75 x 13mm (B)
- 3x Cleaning brush 50mm green (F)
- 3x Cleaning brush 50mm white (G)
- 1x Adapter with thread (H)
- 1x Box (E)



**Nr. 111 024**

Code: OE198000198

**Reinigungsscheiben-Satz, 19-tlg.**

- 5x Reinigungsscheibe 50 x 13mm (A)
- 5x Reinigungsscheibe 75 x 13mm (B)
- 3x Reinigungsbürste 50mm grün (F)
- 3x Reinigungsbürste 50mm weiß (G)
- 1x Aufnahmeschaft mit Gewinde (H)
- 1x Winkelschleifer (I)
- 1x Aufbewahrungsbox (E)



**Nr. 111 024**

Code: OE198000198

**Cleaning discs kit, 19 pcs.**

- 5x Cleaning disc 50 x 13mm (A)
- 5x Cleaning disc 75 x 13mm (B)
- 3x Cleaning brush 50mm green (F)
- 3x Cleaning brush 50mm white (G)
- 1x Adapter with thread (H)
- 1x Air angle grinder (I)
- 1x Box (E)

## REINIGUNGSSCHEIBEN-SORTIMENTSBOX WORKSHOP BOX FOR CLEANING DISCS



**1x Aufnahmeschaft für Roloc Ø50mm**  
1x Adapter for Roloc Ø50mm  
Nr. 111 052



**1x Aufnahmeschaft für Roloc Ø75mm**  
1x Adapter for Roloc Ø75mm  
Nr. 111 076

**1x Spanndorn für Nr. 111 100**  
1x Adapter for no. 111 100  
Nr. 111 002



**5x Ø50 x 13mm**  
Nr. 111 050/PUR



**5x Ø75 x 13mm**  
Nr. 111 075/PUR



**5x Ø100 x 13mm**  
Nr. 111 100/PUR



**5x Ø50 Roloc**  
Nr. 111 350



**5x Ø75 x 13mm**  
Nr. 111 275



**Nr. EQ-0205**

**Länge / length: 600mm**

**Breite / width: 110mm**

**Höhe / height: 170mm**



**Sortimentsbox mit 5 entnehmbaren Fächern** zur praktischen Aufbewahrung von Reinigungsscheiben, Aufnahmeadaptern, Spanndorn etc. Fächerbeschriftung sorgt für zeitsparende Nachbestellung.

**Nr. 111 031** **Reinigungsscheiben-Sortimentsbox Typ 1**  
Code: OE193000193

**Nr. EQ-0205** **Sortimentsbox**  
Code: OE220000022



**Workshop box for save storage of cleaning discs.**

**Workshop box for cleaning discs type 1**

**Workshop box**

## REINIGUNGSSCHEIBEN CLEANING DISCS

**Reinigungsscheiben, passend z.B. für Roloc Aufnahme, max. 10.000 U/min**  
Cleaning disc, suitable e.g. for Roloc holder, max. rpm 10.000



**Ø 50 x 13mm**

**Nr. 111 050/PUR**

Code: OE390000390

**Nr. 111 050**

Code: OE290000290

**Aufnahmeschaft mit Gewinde für Reinigungsscheibe**

Holder shank with thread for cleaning disc

**Ø 75 x 13mm**

**Nr. 111 075/PUR**

Code: OE690000690

**Nr. 111 075**

Code: OE520000520

**50 mm**

**75 mm**

**Nr. 111 052**

Code: OE130000013

**Nr. 111 076**

Code: OE130000013

**Reinigungsscheiben, 13mm Bohrung, max. 6.000 U/min**

Cleaning disc, bore hole 13mm, max rpm 6.000

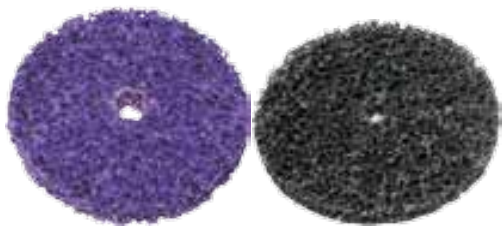

**Ø 100 x 13mm**

**Nr. 111 100/PUR**

Code: OE790000790

**Nr. 111 100**

Code: OE720000720

**Ø 150 x 13mm**

**Nr. 111 150/PUR**

Code: OE1850001850

**Nr. 111 150**

Code: OE120000012

**Nr. 111 002**

Code: OE1280001280

**Spanndorn für Reinigungsscheibe**

Adapter for cleaning disc

**Reinigungsscheibe für Winkelschleifer, max. 6.000 U/min**

Cleaning disc for angle grinder, max rpm 6.000



**Ø 115 x 22 x 13mm**

**Nr. 111 151/PUR**

Code: OE120000012

**Nr. 111 151**

Code: OE880000880

**Reinigungsscheiben, 6mm Schaft, max. 10.000 U/min**

Cleaning disc with 6mm shank, max rpm 10.000



**Ø 50 x 13mm**

**Nr. 111 250/PUR**

Code: OE390000390

**Nr. 111 250**

Code: OE230000230

**Ø 75 x 13mm**

**Nr. 111 275/PUR**

Code: OE690000690

**Nr. 111 275**

Code: OE400000004

## ERSATZ-TRENNSCHEIBEN Ø 100mm x 1,0 x 10mm Bohrung REPLACEMENT CUTTING DISCS Ø 100mm x 1.0 x 10mm



**Nr. 101 100**

Code: OE380000038

**Ersatz-Trennscheiben**

**Ø 100mm, 10 Stk.**



**Nr. 101 100**

Code: OE380000038

**Replacement Cutting**

**discs Ø 100mm, 10 pcs.**



## TRENNSCHEIBENSORTIMENT CUT OFF DISC KIT



Verschiedene Hochleistungs-Mini-Trennscheiben,  
Bohrung 10mm.

**Nr. 110 400 Trennscheibensortiment,  
9tlg.**  
Code: OE380000038



Various high performance Mini cut off discs,  
10mm bore.

**Nr. 110 400 Cut off disc kit, 9pcs.**  
Code: OE380000038

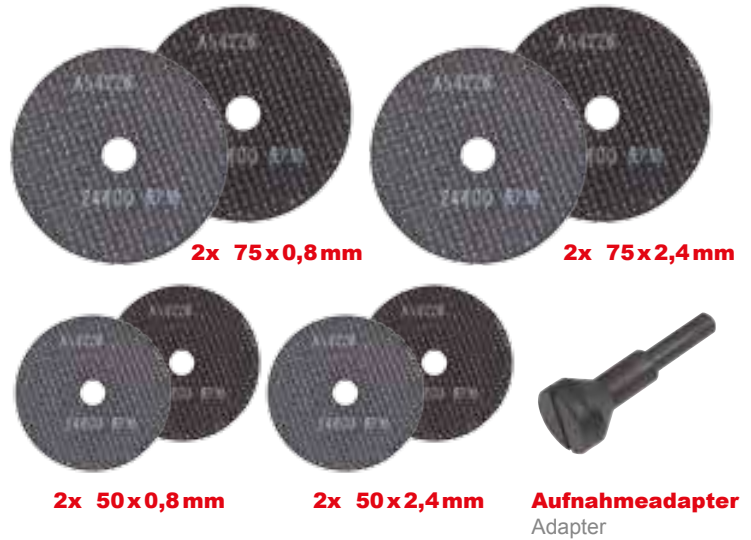

## MINI LAMELENSCHEIBEN MINI FLAP DISC



**optional**

**1x Aufnahmeschaft  
für Roloc Ø 50mm**

1x Adapter for  
Roloc Ø 50mm

**Nr. 111 052**

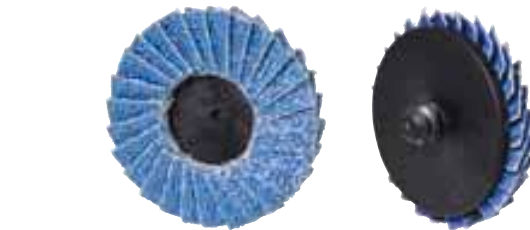

**Nr. 111 550/K40 Mini Lamellenscheiben Ø 50mm,  
Körnung K40, 10er Pack**  
Code: OE290000029

**Nr. 111 550/K60 Mini Lamellenscheiben Ø 50mm,  
Körnung K60, 10er Pack**  
Code: OE290000029

**Nr. 111 550/K80 Mini Lamellenscheiben Ø 50mm,  
Körnung K80, 10er Pack**  
Code: OE290000029



**Mini flap disc Ø 50mm,  
grid K40, 10pack**

**Mini flap disc Ø 50mm,  
grid K60, 10pack**

**Mini flap disc Ø 50mm,  
grid K80, 10pack**

## PUNKTSCHWEISSBOHRER SATZ 5-PACK SPOT WELD DRILL BITS



TICN beschichtet. Bestehend aus 2 x 6,0mm, 3 x 8,0mm.

**Nr. 244 805 Punktschweißbohrer Satz, 5-tlg.**  
Code: OE580000058



**HSSE-Titanium Carbon Nitride!**

**Nr. 244 805 5-pack Spot Welding  
Drill Bits: 2 x 6 mm, 3 x 8 mm**  
Code: OE580000058



## HARTMETALLFRÄSER-SATZ CARBIDE CUTTER KIT



**TIN-beschichtet**  
TIN-coated

**Für Druckluftschleifer  
ab 20.000 U/min.**

For use of air grinder from 20.000 rpm

**Fräser einzeln erhältlich**  
Carbide cutter separately available:

Ø 8mm

Nr. 106 008  
Code: OE380000038

Ø 10mm

Nr. 106 010  
Code: OE380000038

Ø 10mm

Nr. 107 010  
Code: OE440000044

Ø 10mm

Nr. 108 010  
Code: OE440000044

Ø 10mm

Nr. 109 010  
Code: OE440000044



Ø 6mm Schaft / Shaft



**Hochleistungsfräser** zur Bearbeitung von gehärtetem Stahl, Schweißnähten, Gusswerkstoffen usw. Aus Vollmaterial geschliffen. TIN-beschichtet. Zur Verwendung in Druckluftschleifern ab 20.000 U/min. Lieferung komplett im Holzkasten. Schaft ø 6,0 mm.

**Nr. 106 500 Hartmetallfräser Satz 5-tlg.**

Code: OE198000198



**Top quality cutters** for working on hardened steels, welding joints, cast steel. One piece grinded. TIN coated. For the use of air grinders from 20 000 rpm and more. Shipment in massive wood box. Shaft ø 6,0 mm.

**Nr. 106 500 Carbide cutter kit 5pcs.**

Code: OE198000198

## HARTMETALL SCHWEIßPUNKTBOHRER CARBIDE SPOT WELD DRILL BIT



**Nr. 222 050**



**Nr. 222 000**

**3-Mitnahmeflächen**  
3 flat gripping areas

**Ø 8mm Doppel-Vollhartmetall**  
Ø 8mm Double Carbide



Speziell zum Lösen der Schweißpunkte an hochfesten Karosserieblechen. Vollhartmetall Punktschweißbohrer **zum Einsatz in Handbohrmaschinen** (Elektro, Druckluft). Durchdrehen im Bohrfutter wird durch 3 Mitnahmeflächen verhindert.

**Nr. 222 000**

Code: OE149000149

**Doppel-Hartmetall-Punktschweißbohrer 8,0mm, 2-tlg.**  
in Holzkiste

**Nr. 222 050**

Code: OE980000098

**Hartmetall-Punktschweißbohrer 3-schneidig, 8,0x50mm, 2-tlg.**



Made especially for removing spot welds on extremely hard steel materials, such as BTR, BOR. **Use with cordless or air drill.** No turning inside drill chuck, based on the 3 flat gripping areas.

**Nr. 222 000**

Code: OE149000149

**Double Carbide Spot Weld Drill 8,0mm, 2pcs.** in wooden box

**Nr. 222 050**

Code: OE980000098

**Carbide Spot Weld Drill 3-edged 8,0x50mm, 2pcs.**

## HARTMETALL- PUNKTSCHWEIßFRÄSER CARBIDE SPOT WELD DRILL

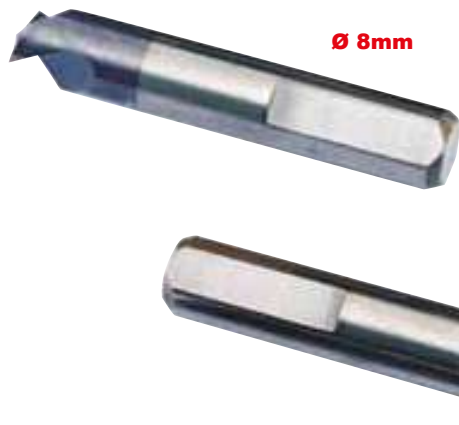

Ø 8mm

**Vollhartmetall Punktschweißfräser**  
Solid carbide spot weld drill



**Speziell zum Lösen der Schweißpunkte an hochfesten Karosserieblechen.** Vollhartmetall Punktschweißfräser zum Einsatz in Druckluftmaschinen. Passend für alle Sorten hochfester Bleche wie z.B. BTR, BOR.

**Nr. 222 300 Punktschweißfräser 8,0x44mm VARIO-DRILL, 2-tlg.**  
Code: OE980000098

**Nr. 222 600 Punktschweißfräser 8,0x45mm SPITZNAGEL, 2-tlg.**  
Code: OE890000089

**Nr. 222 700 Punktschweißfräser 8,0x39mm SPOTLE-DRILL, 2-tlg.**  
Code: OE108000108



**Special made for removing spot welds at extremely hard steel materials.** For use with electric or air drill. Works at all kind of high strengths materials as BTR, BOR.

**Nr. 222 300 Spot weld drill VARIO-DRILL 8,0x44mm, 2pcs.**  
Code: OE980000098

**Nr. 222 600 Spot weld drill SPITZNAGEL 8,0x45mm, 2pcs.**  
Code: OE890000089

**Nr. 222 700 Spot weld drill SPOTLE-DRILL 8,0x39mm, 2pcs.**  
Code: OE108000108

## DOPPEL- PUNKTSCHWEIßBOHRER TWIN-END DRILL



**HSSE Kobaltlegiert Ø 8mm**  
HSSE cobalt alloyed HSS material

**3 Mitnahmeflächen verhindern ein Durchdrehen im Bohrfutter**

No turning inside drill chuck, based on the 3 flat gripping areas



**Entwickelt nach den Anforderungen der Fachwerkstattpraxis.** Neuartiger Punktschweißbohrer. HSSE (kobaltlegiert) mit Sonderschliff. Für den Einsatz in Handbohrmaschinen. Durchdrehen im Bohrfutter wird durch 3 Mitnahmeflächen verhindert. DBGM

**Nr. 222 008 Doppel-Punktschweißbohrer HSSE 8,0mm**  
Code: OE190000019

**Nr. 222 008/3 Doppel-Punktschweißbohrer Satz 3-tlg.**  
Code: OE540000054



**New special made drill for removing spot welds.** For use with electric or air drill. No turning inside drill chuck, based on the 3 flat gripping areas. Made of HSSE (cobalt alloyed HSS material) DBGM

**Nr. 222 008 Twin end drill HSSE 8,0mm**  
Code: OE190000019

**Nr. 222 008/3 Twin end drill HSSE 8,0mm, 3 pcs.**  
Code: OE540000054

## PUNKTSCHWEIß-BOHRER SPOT WELDING DRILL



### Vorteile der TIN-Beschichtung: (Farbe: gold)

- erhöhte Standzeit
- hohe Schnittgeschwindigkeiten
- verminderte Kaltaufschweißneigung

Advantages of TIN-coating (colour: gold)

- long lifetime
- high cutting speeds



### Vorteile der TICN-Beschichtung: (Farbe: grau-violett)

- höchste Werkzeugstandzeiten
- noch höhere Schnittgeschwindigkeiten
- für unterbrochene Schnitte geeignet
- beste Rentabilität

Advantages of TICN-coating (colour: grey-purple)

- long lifetime
- highest cutting speeds
- useable for interrupted cuts
- best profitability



**Kobaltlegiert mit Sonderanschliff.** Beste Qualität, präziser Anschliff. Zum Einsatz in Handbohrmaschinen.



**Cobalt alloyed with special grind.** Best quality, perfect grind. For use by hand drilling machines. Design 10 mm, i.e. Ford Mondeo, DB.

Nr. 244 060 Code: OE810000810	Bohrer HSSE 6,0 x 70mm Drill HSSE 6,0 x 70mm
Nr. 244 008 Code: OE860000860	Bohrer HSSE 8,0 x 80mm Drill HSSE 8,0 x 80mm
Nr. 244 010 Code: OE12000012	Bohrer HSSE 10,0 x 90mm Drill HSSE 10,0 x 90mm
Nr. 244 106 Code: OE109001090	Bohrer HSSE TIN 6,0 x 70mm Drill HSSE TIN 6,0 x 70mm
Nr. 244 108 Code: OE102001020	Bohrer HSSE TIN 8,0 x 80mm Drill HSSE TIN 8,0 x 80mm
Nr. 244 110 Code: OE14000014	Bohrer HSSE TIN 10,0 x 90mm Drill HSSE TIN 10,0 x 90mm
Nr. 244 806 Code: OE127001270	Bohrer HSSE TICN 6,0 x 70mm Drill HSSE TICN 6,0 x 70mm
Nr. 244 808 Code: OE127001270	Bohrer HSSE TICN 8,0 x 80mm Drill HSSE TICN 8,0 x 80mm
Nr. 244 210 Code: OE17000017	Bohrer HSSE TICN 10,0 x 90mm Drill HSSE TICN 10,0 x 90mm

## PUNKTSCHWEIß-FRÄSER SPOT WELDING DRILL SHORT



### Vorteile der TICN-Beschichtung: (Farbe: grau-violett)

- höchste Werkzeugstandzeiten
- noch höhere Schnittgeschwindigkeiten
- für unterbrochene Schnitte geeignet
- beste Rentabilität

Advantages of TICN-coating (colour: grey-purple)

- long lifetime
- highest cutting speeds
- useable for interrupted cuts
- best profitability



Nr. 404 080

Nr. 404 008

8 x 39mm



Nr. 404 108

Nr. 404 408

8 x 44mm



Nr. 404 608

Nr. 404 780

8 x 45mm



**Präziser Anschliff** mit Führungsfase und Mitnahmefläche. Passend z.B. für Vario-Drill WS 90, etc.



**Perfect grind** with cone and flat. Suitable i.e. Vario Drill, Spitznagel-Drill.

Nr. 404 080 Code: OE122001220	SPOTLE-Fräser HSSE 8,0 x 39mm SPOTLE-drill HSSE 8,0 x 39mm
Nr. 404 008 Code: OE151001510	SPOTLE-Fräser HSSE TICN 8,0 x 39mm SPOTLE-drill HSSE TICN 8,0 x 39mm
Nr. 404 108 Code: OE128001280	VARIO-Fräser HSSE 8,0 x 44mm VARIO-drill HSSE 8,0 x 44mm
Nr. 404 408 Code: OE16000016	VARIO-Fräser HSSE TICN 8,0 x 44mm VARIO-drill HSSE TICN 8,0 x 44mm
Nr. 404 608 Code: OE128001280	SPITZNAGEL HSSE 8,0 x 45mm SPITZNAGEL HSSE 8,0 x 45mm
Nr. 404 780 Code: OE151001510	SPITZNAGEL HSSE TICN 8,0 x 45mm SPITZNAGEL HSSE TICN 8,0 x 45mm



## SCHWEIßPUNKT-LÖSER AIR SPOTWELDING DRILL

**Nr. 404 108**

Code: OE128001280

8 x 44 mm

**Nr. 404 408**

Code: OE160000016



**Nr. 222 308**

Code: OE490000049

**Punktschweißfräser 8,0 x 44 mm.  
Passend für EQ-401 001.**

Carbide spot weld drill bit 8,0 x 44 mm.  
Fits the EQ-401 001.

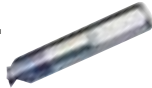

**Zum Lösen der Schweißpunkte an Karosserieblechen.** Mit entsprechenden Bohrern auch für hochfeste Bleche geeignet. Bohrtiefe stufenlos einstellbar. Gegenhaltebügel drehbar und abnehmbar, somit auch für schwer zugängliche Stellen geeignet.

**Nr. EQ-401 001 Schweißpunkt-Löser  
"VARIO-drill"**

Code: OE598000598



**The Tool to use for drilling High Strength Steel!** Operates at 1200rpm or less. Drill bits will last longer. Use for removing spot welds on all flanges. Comes with removable "G-clamp". Adjustable depth to ensure there is no drilling in second panel. To extend the life of the drill bit, use the center punch and the special cutting oil.

**Air spotwelding drill "VARIO-drill"**

## SCHWEISSPUNKT-LÖSER AIR SPOTWELDING DRILL



**Hochleistungs-Schweißpunkt-Fräsmaschine** zum Lösen der Schweißpunkte an Karosserieblechen. Auch geeignet für hochfeste Karosseriebleche. Klemmbügel verstellbar, somit auch Arbeiten an schwer zugänglichen Positionen möglich. (Bodenblech, Heckraum etc.)

**Nr. EQ-404 Schweißpunkt-Löser  
"SPOTLE"**

Code: OE598000598



**Professional pneumatically driven spotwelding milling machine.** The machine enables you to remove all spot welds from the body work. The machine's clamping bracket is adjustable to the left or the right. That generates works e.g. spot welds at a bottom plate.

**Nr. EQ-404 Air spotwelding drill  
"SPOTLE"**

Code: OE598000598



**Verstellbarer Klemmbügel**  
Clamping bracket is adjustable

MÜLLER-WERKZEUG Technische Daten / technical information		
Antrieb / drive	mm	8,0
Gewicht / weight	Kg	1,8
Max. Bohrtiefe / stroke length	mm	68
Anschlussgewinde / air nipple	Zoll	1/4"
Schlauchanschluss / air hose	mm	9-13
Luftverbrauch / air consumption	l/min	350
Drehzahl/min / free speed	Rpm	25000
Arbeitsdruck / air pressure	bar	6,2
Geräuschpegel / sound level	dBA	71



8 x 39 mm



**Nr. 404 080**  
Code: OE122001220



**Nr. 404 008**  
Code: OE151001510

## **XL-LINKSBOHRER-SATZ HSSE-TIN** **XL-LEFT DRILL BIT KIT**



**Überlänge 180mm.** Cobaltlegiert HSSE-TIN. Zum Ausbohren abgerissener Schrauben. Für vertieft liegende, schwer zugängliche Schrauben, Bolzen, wie z.B. Motor, Auspuff, Zylinderkopf etc. Exaktes und präzises Bohren auch von gehärteten und vergüteten Materialien bis Festigkeit 10.9.

**Nr. 562 180 XL-Linksbohrer-Satz HSSE-TIN, 5-tlg.**  
Code: OE156201562



**XL-length 180mm.** Cobalt alloyed HSSE-TIN. For drilling broken bolts, studs, screws. For deep placed, hard to reach areas e.g. at engine, exhaust, cylinder head etc. Perfect for high strength materials until 10.9.

**Nr. 562 180 XL-left drill bit kit, 5 pcs.**  
Code: OE156201562

## **LINKSBOHRER-SATZ FÜR SCHRAUBENAUSDREHER HSSE-TIN** **LEFT DRILL BIT KIT HSSE-TIN**



Spezial-Linksbohrer Satz, passend für Ausdrehsätze. Kobaltlegiert HSSE-TIN.

**Zum Ausbohren abgerissener Schrauben, Bolzen wie z. B. Motor, Auspuff, Zylinderkopf etc.**

Durch linksschneidende Ausführung werden die abgerissenen Schrauben oft schon beim Bohren mit herausgedreht.

5-teiliger Satz: Ø 3,2, 4,8, 6,4, 8,0, 8,7mm

Robust und stabil durch **verstärkten Kerndurchmesser**. Profilschleifen. Hohe Rundlaufgenauigkeit. Exaktes und präzises Bohren auch von **gehärteten und vergüteten** Materialien bis **Festigkeit 10.9** als auch VA Stähle, Federstähle, austenitische und hoch-hitzebeständige Stähle.

**Nr. 562 300 Linksbohrer-Satz für Schraubenausdreher HSSE-TIN**  
Code: OE999009990



**For drilling broken bolts, studs, screws etc. until a quality of 10.9.** Can be used as well for high strength and heat treated. Extra thick drill core. Special drill tip grinding. Short and strong.  
**Left drill bit kit HSSE-TIN**

## HARTMETALLBOHRER SATZ CARBIDE TIP DRILLS KIT



Zum Bohren von sehr harten Materialien wie z. B. ausgeglühte Stehbolzen, Schrauben bis 12.9 etc.  
Weitere Größen auf Anfrage lieferbar.

### Nr. 562 600 Hartmetallbohrer Satz 4 tlg.

Code: OE980000098



For drilling of extremely hard materials such as glow studs, bolts till 12.9... Other sizes available on special request.

### Nr. 562 600 Carbide tip drills kit 4pcs

Code: OE980000098

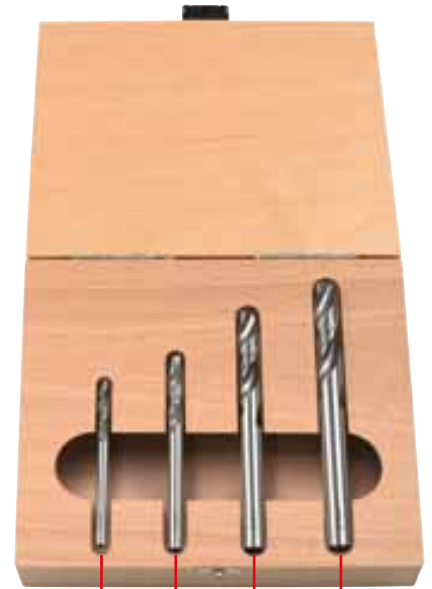

Nr. 562 603  
3,0mm

Nr. 562 604  
4,0mm

Nr. 562 606  
6,0mm

Nr. 562 607  
7,0mm

## LINKSBOHRER-SATZ LEFT DRILL BIT KIT

**Lieferung in Holzbox**  
Shipment incl. wood box



Zum Ausbohren abgerissener Schrauben, Stehbolzen etc. bis Festigkeit 10.9. Einsetzbar auch für vergütete, hochfeste Materialien. Verstärkte Kerndicke. Kreuzauspitzung bei allen Größen. Kurze und robuste Sonderausführung.

### Nr. 562 400 Spiralbohrersatz, HSSE-TIN, linksschneidend, 4-tlg.

Code: OE710000071

### Nr. 562 800 Spiralbohrersatz, HSSE-TIN, linksschneidend, 8-tlg.

Code: OE122000122



For drilling broken bolts, studs, screws etc. until a quality of 10.9. Can be used as well for high strength and heat treated. Extra thick drill core. Special drill tip grinding. Short and strong.

### Nr. 562 400 Left drill bit kit, HSSE-TIN, 4 pcs.

Code: OE710000071

### Nr. 562 800 Left drill bit kit, HSSE-TIN, 8 pcs.

Code: OE122000122



Nr. 562 430  
3,0mm



Nr. 562 440  
4,0mm



Nr. 562 460  
6,0mm



Nr. 562 470  
7,0mm

### Vorteile der TIN-Beschichtung: (Farbe: gold)

- erhöhte Standzeit
- hohe Schnittgeschwindigkeiten
- verminderte Kaltaufschweißneigung

Advantages of TIN-coating  
(colour: gold)

- long lifetime
- high cutting speeds



**Universell einsetzbarer Schrauben-Ausdrehsatz.**  
Mit diesem Satz lassen sich z.B. abgerissene Kurbelwellenschrauben mit einer Festigkeit von 10.9 problemlos ausbohren.

**Nr. 562 900 Schrauben-Ausdrehsatz 9-tlg.**  
Code: OE112000112



**Universally useable drill kit** for broken studs, bolts. Can be used also for heat treated bolts (10.9 quality) at crankshaft.

**Nr. 562 900 Screw extractor kit 9 pcs.**  
Code: OE112000112



**Anwendungsbeispiel: Abgerissene Kurbelwellenschrauben bis 10.9 ausbohren**

Example of use: Can be used for heat treated bolts at crankshaft (10.9)

## SCHRAUBEN-AUSDREHSATZ SCREW EXTRACTOR KIT



**Linksbohrer Ø 3, 4, 6 + 7mm, TIN-beschichtet**  
Left drill bit  
Ø 3, 4, 6 + 7mm, TIN coated



**Länge: 180mm**  
Length: 180mm

**Länge: 130mm**  
Length: 130mm



## TIGERSÄGEBLATT SPEZIALZAHNUNG SAWBLADE

**Passend für Tigersäge**  
Made for use with Tigersaw



**Müller HSS Bi-Metall Spezialsägeblatt, 180 / 130mm, VPE 10 Stk. Passend für Tigersäge.**

**Nr. 212 420 Tigersägeblatt 180mm, Spezialzahnung, 10 Stk.**  
Code: OE660000066

**Nr. 212 454 Tigersägeblatt 130mm, Spezialzahnung, 10 Stk.**  
Code: OE660000066



**Müller HSS Bi metal special saw blade, 180/130mm, 10 pcs. packed. Made for the Tigersaw.**

**Saw-blades 180mm, 10 pcs.**

**Saw-blades 130mm, 10 pcs.**



**Hartmetall Sägeblatt für hochfesten Stahl und hochfeste Bleche.** Ideal z.B. zum Durchtrennen der extrem harten Edelstahlrohre (V2A) bei Auspuffanlagen (AUDI, VAG etc.). Passend für Tigersäge. VPE 2 Stk. Länge: 150mm.

**Nr. 212 456 Hartmetall Sägeblatt für hochfeste Stähle/Bleche**  
Code: OE560000056



**CARBIDE saw blade especially made for cutting the extreme hard stainless materials, e.g. V2A exhaust system (AUDI, VAG etc.)** For use with Tigersaw. 2 pcs.

**Nr. 212 456 Carbide saw blade 2 pcs.**  
Code: OE560000056

## HARTMETALL SÄGEBLATT FÜR HOCHFESTE BLECHE CARBIDE SAW BLADE

**Länge: 150mm**  
Length: 150mm



**Passend für Tigersäge**  
Made for use with Tigersaw

## ERSATZ-SÄGEBLÄTTER, 20 STK. SAW-BLADES, 20 PCS.

Nr. 235 014

Nr. 235 010 / 011 / 018



Nr. 290 113  
MÜLLER Druckluftsäge  
MUELLER air saw  
Seite / page 1- 05

passend für MÜLLER-Druckluftsägen Nr. 290 113 und Nr. 290 114.  
fits for MUELLER air saws

Nr. 235 014	Code: OE40404040	Nr. 235 011	Code: OE40404040
Sägeblätter / Saw-blades	Z-14	Sägeblätter / Saw-blades	Z-24
Nr. 235 018	Code: OE40404040	Nr. 235 010	Code: OE40404040
Sägeblätter / Saw-blades	Z-18	Sägeblätter / Saw-blades	Z-32



passend für PLF80/90 / fits for PLF80/90:

Nr. 235 004	Code: OE40404040	Nr. 235 002	Code: OE40404040
Sägeblätter / Saw-blades	Z-14	Sägeblätter / Saw-blades	Z-24
Nr. 235 005	Code: OE40404040	Nr. 235 003	Code: OE40404040
Sägeblätter / Saw-blades	Z-18	Sägeblätter / Saw-blades	Z-32



Nr. 290 114  
MÜLLER 114 Getriebe-Druckluftsäge  
MUELLER 114 Gear transmitted air saw  
Seite / page 1- 05

## AHLENSATZ FÜR PARKSENSOREN VAG REAMER KIT FOR PARKING SENSORS VAG

Nr. 245 101

**Typ I für VAG ORIGINAL Einparkhilfe (werkseitig)**  
**z.B. VW EOS, VW Golf 5, VW GOLF Variant etc.**

Type I for OEM VAG ORIGINAL park sensors e.g. VW EOS, VW Golf 5, VW GOLF Variant etc.

Nr. 245 102

**Typ II für VAG-ETKA Katalog Nachrüstsatz z.B.**  
**VW Polo, VW Passat, VW Golf 5, VW Sharan etc.**

Type II for VAG-ETKA catalog (aftermarket) park sensor e.g. VW Polo, VW Passat, VW Golf 5, VW Sharan etc.

Zylindrischer  
Ahlenteil  
cylindric part

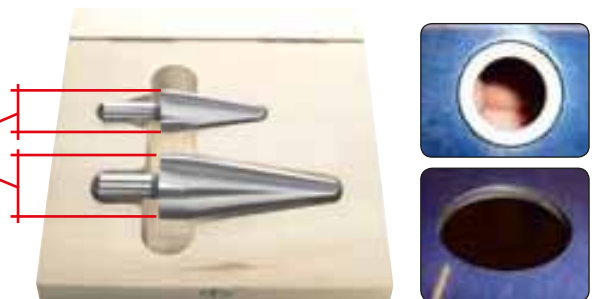

**Ahleinsatz zur Herstellung eines exakt runden Bohrloches**  
an lackierten Kunststoffstoßstangen. Keine Beschädigung der Lack-  
schicht. Keine Verformung der sehr teuren Kunststoffstoßstangen.

Nr. 245 100 **Ahleinsatz Typ I + II, 4-tlg.**  
Code: OE228000228

Nr. 245 101 **Ahleinsatz Typ I**  
für **Original Einparkhilfe VAG, 2-tlg.**  
Code: OE128000128

Nr. 245 102 **Ahleinsatz Typ II**  
für **ETKA Nachrüstsatz, 2-tlg.**  
Code: OE118000118



**Reamer kit for exactly round holes** of parking  
sensors VAG. No damage of paint.

**Reamer kit I + II, 4 pcs.**

**Reamer kit I,**  
**original parking sensor VAG, 2 pcs.**



**Reamer kit II,**  
**for parking Sensor ETKA, 2 pcs.**

## ERSATZSCHLEIFBÄNDER REPLACEMENT BELTS

**Schleifband Breite: 10mm x 330mm**  
Belt width: 10mm x 330mm



**Nr. 290 165**  
**DL-Bandschleifer komplett mit 15 Schleifbändern**  
**Air Belt Grinder complete with 15 belts**  
Seite / page 1- 06

	Nr. 290 040 Code: OE580000058	Ersatzschleifband K-40 (VPE 25 Stück), braun		Replacement belt K-40 (package 25 pcs.), brown
	Nr. 290 060 Code: OE580000058	Ersatzschleifband K-60 (VPE 25 Stück), braun		Replacement belt K-60 (package 25 pcs.), brown
	Nr. 290 080 Code: OE580000058	Ersatzschleifband K-80 (VPE 25 Stück), braun		Replacement belt K-80 (package 25 pcs.), brown
	Nr. 290 120 Code: OE640000064	Ersatzschleifband K-120 (VPE 25 Stück), braun		Replacement belt K-120 (package 25 pcs.), brown
	Nr. 290 041 Code: OE590000059	Spezialschleifband K-40 (VPE 25 Stück), grün		Special belt K-40 (package 25 pcs.), green
	Nr. 290 061 Code: OE590000059	Spezialschleifband K-60 (VPE 25 Stück), grün		Special belt K-60 (package 25 pcs.), green
	Nr. 290 081 Code: OE590000059	Spezialschleifband K-80 (VPE 25 Stück), grün		Special belt K-80 (package 25 pcs.), green
	Nr. 290 121 Code: OE680000068	Spezialschleifband K-120 (VPE 25 Stück), grün		Special belt K-120 (package 25 pcs.), green

## GEWINDE-REPARATUR-SATZ THREAD REPAIR KIT



**Universelles Erneuerungswerkzeug** mit Büchsen, welche sich das erforderliche neue Gewinde durch die angebrachten Schlitz selbst schneiden. Für fast alle Materialien wie z.B. Alu, Stahl, Kunststoff, Gusseisen etc.



**Universally useable thread restore system.** Based on the slots the thread inserts are self-cutting. Works on nearly all materials as steel, aluminium, castings, plastics. 3-fluted special drill for exactly holes.

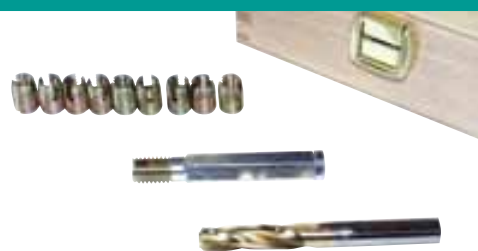

### Gewinde-Reparatur-Werkzeug Thread Repair Kit

Nr. 505 004 M4 Code: OE420000042	Nr. 505 008 M8 Code: OE940000094	Nr. 505 016 M16 Code: OE140000140	Nr. 505 208 M8x1 Code: OE940000094	Nr. 505 412 M14x1,25 Code: OE135000135
Nr. 505 005 M5 Code: OE680000068	Nr. 505 010 M10 Code: OE104000104	Nr. 505 018 M18 Code: OE198000198	Nr. 505 210 M10x1,25 Code: OE138000138	Nr. 505 214 M14x1,5 Code: OE135000135
Nr. 505 006 M6 Code: OE780000078	Nr. 505 012 M12 Code: OE122000122		Nr. 505 812 M12x1,25 Code: OE122000122	Nr. 505 216 M16x1,5 Code: OE140000140
Nr. 505 007 M7 Code: OE940000094	Nr. 505 014 M14 Code: OE135000135		Nr. 505 212 M12x1,5 Code: OE122000122	Nr. 505 218/L M18x1,5 Code: OE980000098

**Ersatz-Büchsen VPE 10 Stk.** Thread inserts, 10 pcs. packed

Nr. 505 104 M4	Nr. 505 108 M8	Nr. 505 116 M16	Nr. 505 308 M8x1	Nr. 505 414 M14x1,25
Nr. 505 105 M5	Nr. 505 110 M10	Nr. 505 319 M18	Nr. 505 310 M10x1,25	Nr. 505 314 M14x1,5
Nr. 505 106 M6	Nr. 505 112 M12		Nr. 505 313 M12x1,25	Nr. 505 316 M16x1,5
Nr. 505 107 M7	Nr. 505 114 M14		Nr. 505 312 M12x1,5	Nr. 505 318/L M18x1,5



**MÜLLER Tipp:**  
elektronisches Dokument  
Artikelsuche mit "Strg + F"

**MUELLER Tip:**  
electronic document  
Product Search "Ctrl + F"

**Apple:** "⌘ + F"

# KAROSSERIE / VERSCHLEIß AUTO BODY / CONSUMABLES

## UNIVERSAL REINIGUNGSSET FÜR KONTAKTFLÄCHEN AIR ANGLE GRINDER KIT



**Nr. 111 812**

MÜLLER-WERKZEUG Technische Daten / technical information		
Gewicht / weight	Kg	0,50
Länge / length	mm	120
Anschlussgewinde / air nipple	Zoll	1/4"
Schlauchanschluss / air hose	mm	9-13
Luftverbrauch / air consumption	l/min	250
Drehzahl/min / rpm	Rpm	15000
Arbeitsdruck / air pressure	bar	6,2
Geräuschpegel / sound level	dBA	85



**optional**  
**Mini Lamellenscheiben  
Ø 50mm, 10er Pack**  
Mini flap disc Ø 50mm, 10pack

**Nr. 111 550/K40 Körnung K40**  
Code: OE290000029 grid K40

**Nr. 111 550/K60 Körnung K60**  
Code: OE290000029 grid K60

**Nr. 111 550/K80 Körnung K80**  
Code: OE290000029 grid K80



**Nr. 111 816**  
Code: OE128000128

**2-stufig,  
8.000 / 15.000 U/min**  
2-steps,  
8.000 / 15.000 RPM

### Einzelteile / spare parts:

**grobe Körnung**  
rough grain



**Nr. 111 050**  
Code: OE2900000290

**extra grobe Körnung**  
extra rough grain



**Nr. 111 050/PUR**  
Code: OE3900000390

**feine Körnung**  
fine grain



**Nr. 111 360**  
Code: OE980000980

**mittlere Körnung**  
medium grain



**Nr. 111 350**  
Code: OE980000980

**grobe Körnung**  
rough grain



**Nr. 111 350/PUR**  
Code: OE980000980



**Ergonomischer Winkelschleifer, 2-stufig.** Optimale Handhabung durch 70° Winkelstellung. 2-stufig, 8.000 / 15.000U/min. Schnellwechselschleifteller Ø 50mm. Passend für Roloc-System zum Schleifen, Entgraten, Polieren und Finishen. Zum Beispiel für Radnaben etc. 16-tlg.

**Nr. 111 812 Universal Reinigungsset für Kontaktflächen, 16-tlg.**  
Code: OE198000198



**Ergonomic angle grinder.** 70° angle head for optimized use. 2-step, 8000 / 15.000RPM. Quick-change pad Ø 50mm. Fits for Roloc-system sanding pad. Max speed: 15.000RPM. 16 pcs. kit.

**Air Angle Grinder Kit, 16 pcs.**



## MÜLLER DRUCKLUFTSÄGE MUELLER AIR SAW



Durch die sehr hohe Hubzahl perfekt für Bleche und Dünnscheibe 0,4-3mm z. B. bei Karosseriearbeiten. Auch für Kunststoffe, Fiberglas, Kompositmaterial etc. geeignet. Sehr ruhiger und vibrationsarmer Lauf. Temperaturisolierter Griff. Auspuff nach hinten.

### Nr. 290 113 MÜLLER Druckluftsäge

Code: OE298000298



Based on the high speed stroke this tool is ideal for steel sheets 0,4 to 3 mm, works as well for plastics, fiberglass, composites etc. Smooth cutting action. Comfort temperature insulated grip handle. Low vibration (2.99 m/s<sup>2</sup>) Smooth trigger with safety lever for easy operation. Rear exhaust.

### Nr. 290 113 MUELLER air saw

Code: OE298000298



MÜLLER-WERKZEUG		Nr.	Nr.
Technische Daten / technical information		290 113	290 114
Länge / length	mm	238	270
Hub / stroke-length	mm	10	10
Anschlussgewinde / air nipple	Zoll	1/4"	1/4"
Schlauchanschluss / air hose	mm	9-13	9-13
Luftverbrauch / air consumption	l/min	250	250
Hub/min / free speed	Bpm	9.800	7.500
Arbeitsdruck / air pressure	bar	6,3	6,2
Gewicht / weight	Kg	0,69	0,90

## MÜLLER114 GETRIEBE-DRUCKLUFTSÄGE GEAR TRANSMITTED AIR SAW



**MÜLLER 114 Getriebe-Druckluftsäge** mit völlig neuartigem Design. Extrem kraftvoll und sehr geringes Gewicht. Ergonomisch angepasster Griff. Abluftgeräusch gedämmt nach vorne. Ideal für Arbeiten an schwer erreichbaren Stellen.

### Nr. 290 114 MÜLLER 114 Getriebe-Druckluftsäge

Code: OE398000398



**This new gear transmitted air saw cuts deeper** and more powerful as any competition. The front exhaust technology provides increased performance. Small size allows for great access into tight work areas. Rotable exhaust ring between housing and head.

### MUELLER 114 Gear transmitted air saw



### Ersatz-Sägeblätter, 20 Stk. / Saw-blades, 20 pcs.



**Nr. 235 014** Code: OE40404040  
Sägeblätter / Saw-blades **Z-14**

**Nr. 235 018** Code: OE40404040  
Sägeblätter / Saw-blades **Z-18**

passend für MÜLLER-Druckluftsägen  
fits for MUELLER air saws  
Nr. 290 113 und Nr. 290 114.

**Nr. 235 011** Code: OE40404040  
Sägeblätter / Saw-blades **Z-24**

**Nr. 235 010** Code: OE40404040  
Sägeblätter / Saw-blades **Z-32**



**Nr. 235 004** Code: OE40404040  
Sägeblätter / Saw-blades **Z-14**

**Nr. 235 005** Code: OE40404040  
Sägeblätter / Saw-blades **Z-18**

passend für PLF80/90:  
fits for PLF80/90:

**Nr. 235 002** Code: OE40404040  
Sägeblätter / Saw-blades **Z-24**

**Nr. 235 003** Code: OE40404040  
Sägeblätter / Saw-blades **Z-32**

**SCHWEIßPUNKT-LÖSER**  
**AIR SPOTWELDING DRILL**

**Nr. 404 108**  
Code: OE128001280  
8 x 44 mm

**Nr. 404 408**  
Code: OE16000016



**Nr. 222 308**  
Code: OE490000049

**Punktschweißfräser 8,0 x 44 mm.**  
**Passend für EQ-401 001.**  
Carbide spot weld drill bit 8,0 x 44 mm.  
Fits the EQ-401 001.

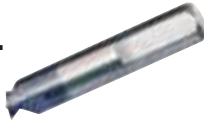

 **Zum Lösen der Schweißpunkte an Karosserieblechen.** Mit entsprechenden Bohrern auch für hochfeste Bleche geeignet. Bohrtiefe stufenlos einstellbar. Gegenhaltebügel drehbar und abnehmbar, somit auch für schwer zugängliche Stellen geeignet.

 **The Tool to use for drilling High Strength Steel!** Operates at 1200rpm or less. Drill bits will last longer. Use for removing spot welds on all flanges. Comes with removable "G-clamp". Adjustable depth to ensure there is no drilling in second panel. To extend the life of the drill bit, use the center punch and the special cutting oil.

**Nr. EQ-401 001 Schweißpunkt-Löser**  
Code: OE598000598

**Air spotwelding drill**

**SCHWEIßPUNKT-LÖSER**  
**AIR SPOTWELDING DRILL**

<b>MÜLLER-WERKZEUG</b> Technische Daten / technical information		
Antrieb / drive	mm	8,0
Gewicht / weight	Kg	1,8
Max. Bohrtiefe / stroke length	mm	68
Anschlussgewinde / air nipple	Zoll	1/4"
Schlauchanschluss / air hose	mm	9-13
Luftverbrauch / air consumption	l/min	350
Drehzahl/min / free speed	Rpm	25000
Arbeitsdruck / air pressure	bar	6,2
Geräuschpegel / sound level	dBA	71



 **Hochleistungs-Schweißpunkt-Fräsmaschine** zum Lösen der Schweißpunkte an Karosserieblechen. Auch geeignet für hochfeste Karosseriebleche. Klemmbügel verstellbar, somit auch Arbeiten an schwer zugänglichen Positionen möglich. (Bodenblech, Heckraum etc.)

 **Professional pneumatically driven spotwelding** milling machine. The machine enables you to remove all spot welds from the body work. The machine's clamping bracket is adjustable to the left or the right. That generates works e.g. spot welds at a bottom plate.

**Nr. EQ-404 Schweißpunkt-Löser**  
Code: OE598000598

**Air spotwelding drill**

**Verstellbarer Klemmbügel**  
Clamping bracket is adjustable



8 x 39 mm

**Nr. 404 080**  
Code: OE122001220

**Nr. 404 008**  
Code: OE151001510



6 Karosserie/Verschleiß AutoBody/Consumables  
 Universal-Werkzeuge Universal Tools  
 7 Transporter & LKW Heavy Duty & Trucks  
 8 Equipment  
 9 Inhaltsverzeichnis Table of Contents

## KAROSSERIE-TRENNMEIßEL WELD BREAKER

- Überlange, brünierte Ausführung
- DIN 7255
- nachschleifbar
- Schneidstärke 2,5 mm
- Länge: 300 mm

- DIN 7255
- can be grinded by hand
- extremely thin 3/32" (2,5 mm)
- Length: 12" (300 mm)

**Extra dünne Sonderanfertigung**  
Extremely thin specialty tool



**Seitliche Schneidkante**  
Half round cutting edge at the side



**Speziell zum Trennen bzw. Lösen von Karosserieteilen** an Punktschweißnähten. Perfekt geeignet zum Lösen der Karosserieteile nach dem Aufbohren der Schweißpunkte. Zum Trennen von Blechen durch Einsatz der seitlichen Schneidkante. Extra dünne Sonderanfertigung.

**Nr. 243 002/HS** Karosserie-Trennmeißel mit Handgriff  
Code: OE325003250

**Nr. 243 002** Karosserie-Trennmeißel  
Code: OE305003050

**Nr. 243 001** Karosserie-Meißel mit Handgriff  
Code: OE198001980

Nr. 243 002/H Handgriff  
Code: OE900000009



**Especially made to cut parts of the body** after drilling out the spot welds. The spot welds are not completely detached because of paint or glue remainders. Sheet metal are cut with the half-round cutting edge at the side. Extremely thin specialty tool.

**Weld breaker with protection rubber handle**

**Weld breaker**

**Metal shield chisel**

Protection rubber handle



## KAROSSERIE-SPANNHALTER BODY WORK FILE HOLDER



**Robuste, aber leichte Ausführung für 14" Feilenblätter.**

**Nr. 262 001** Karosserie-Spannhalter  
Code: OE295002950



**Strong and light type for 14" file blade.**

**Body work file holder**



**Nr. 263 001** Code: OE326503265  
Feilenblatt radial gefräst, mittelfein /  
File blades radial cut, medium fine

**Nr. 263 002** Code: OE311503115  
Feilenblatt radial gefräst, grob /  
File blades radial cut, coarse



**Nr. 263 003** Code: OE296002960  
Feilenblatt schräg gefräst, mittelfein /  
File blades diagonal cut, medium fine

**Nr. 263 004** Code: OE285502855  
Feilenblatt schräg gefräst, grob /  
File blades diagonal cut, coarse

## KUNSTSTOFF-NIETSATZ PLASTIC POP RIVETER



**Nr. 266 051**

Code: OE54000054

Nietzange / Riveter

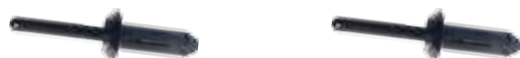

**Nr. 266 052** Code: OE14000014

5 x 15,8, VPE 25 Stk. / 25 pcs.

**Nr. 266 053** Code: OE14000014

5 x 17,2, VPE 25 Stk. / 25 pcs.

**Nr. 266 054** Code: OE14000014

6,6 x 17,2 VPE 25 Stk. / 25 pcs.

**Nr. 266 055** Code: OE14000014

6,3 x 25,2 VPE 25 Stk. / 25 pcs.



**Nr. 266 050**

**Inkl. Kunststoffnieten** / Incl. plastic pop:  
5 x 15,8 5 x 17,2 6,6 x 17,2 6,3 x 25,2

**Lieferung in Metallbox**

Shipment incl. metal box



**Passend für fast alle Kunststoffnieten** an europäischen, asiatischen und amerikanischen Fahrzeugen. Satz komplett mit Nieten.

**Nr. 266 050 Kunststoff-Nietsatz**

Code: OE68000068



**Suitable for almost all plastic pop rivets** at european, asian and american vehicles. Kit includes rivets.

**Plastic pop riveter**

## MONTAGEKEIL TRIM CLIP TOOL



- Türverkleidungen
- Verschluss-Stopfen, Clips aus Plastik
- Schutzkappen der Holscharnierbolzen
- Betätigungs-knöpfe an Heizung, Radio usw.
- Zierleisten und Fensterleisten
- Ohne Beschädigung von Lack, Kunststoff- und Metallteilen

- Door trim
- Plastic-clips
- Inside mirror
- Knobs from heater, radio etc.
- Window mouldings and trims
- Without damage to paint, plastic and metal pieces



**Eine Kombination von Zierleistenkeil und Türverkleidungs-Lösewerkzeug.** Schnelles und einfaches Lösen.

**Nr. 267 002 Montagekeil**

Code: OE990000990



**A combination of a moulding wedge and door trim remover.** Fast and easy removal.

**Trim clip tool**

## FENSTERLEISTEN HEBER WINDOW MOULDING REMOVER



**Unzerbrechlich**  
Unbreakable



- Hebelausnutzung über gesamte Breite, keine Beschädigung der zu bearbeitenden Leisten
- Problemloses Ansetzen durch angefasste Einführschrägen
- Bestens geeignet auch für gewölbte Flächen
- Rückseite mit halbrundem Profil zum Eindrücken der Leisten
- Passend für alle PKW mit Schachtabdeckung wie z. B. Opel, Ford, DB oder die 3er-Reihe von BMW

- Spreads force over total width, no damage to mouldings and trims
- Problem free use due to bevelled edge

**Schlagfester Kunststoff**  
Shock resistant plastic



**Das perfekte Werkzeug** für alle Arbeiten an Schachtabdeckungen und Zierleisten.

**Nr. 267 400 Fensterleisten Heber**  
Code: OE57000057



**The perfect tool** for all works on window mouldings and trims.

**Window moulding remover**

## VERKLEIDUNGSLÖSER HECKKLAPPE FINISH PANEL DETACHEMENT

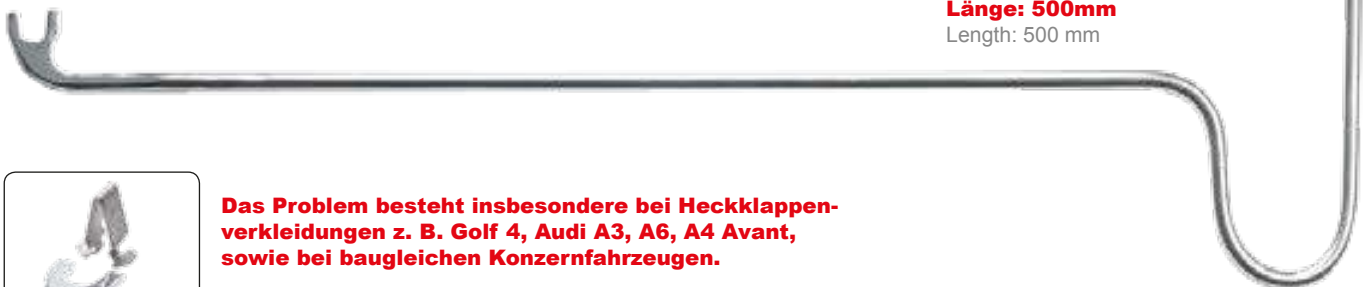

**Länge: 500mm**  
Length: 500 mm



**Das Problem besteht insbesondere bei Heckklappenverkleidungen z. B. Golf 4, Audi A3, A6, A4 Avant, sowie bei baugleichen Konzernfahrzeugen.**

The problem is particularly prevalent in the tailgate finish panels of e.g. Golf 4, Audi A3, A6, A4 Avant, and identical group vehicles.



**Universal-Hilfsmittel** zur De- und Montage der schwer zugänglichen Haltefedern an Fahrzeugverkleidungen.

**Nr. 267 500 Verkleidungslöser Heckklappe**  
Code: OE499004990



**Universal aid** for the assembly and disassembly of the retaining springs in less easily accessible vehicle finish panels.

**Finish panel detachment**

**HARTMETALL  
SCHABER SATZ**  
CARBIDE SCRAPER KIT

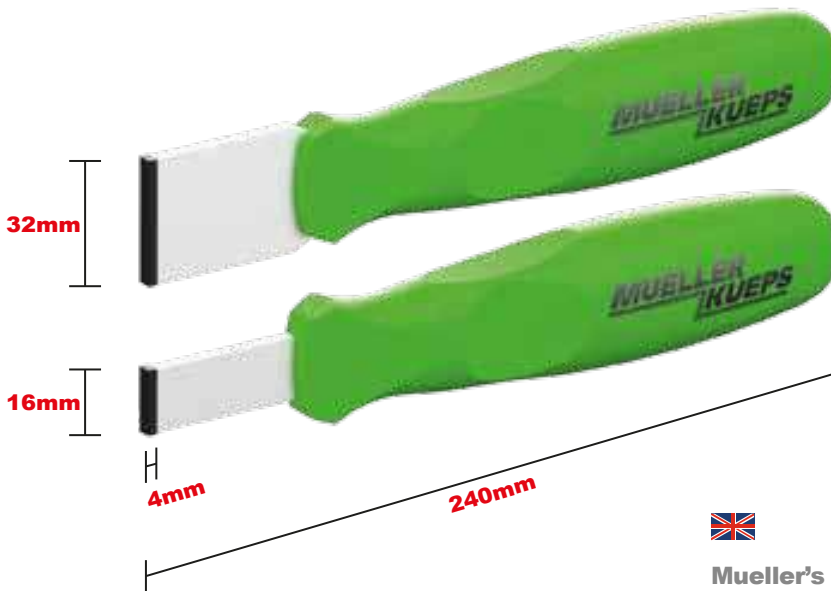

**Mueller's gasket; corrosion and carbon scraper**

- Double edge blade
- Extremely durable due to high quality carbide inserts
- Works as pull or push tool
- Ergonomic hand grip
- Removes paint and glue in hard to reach areas
- Removes burned in corrosion on brakes
- Carbon on exhaust manifold etc.

**Carbide Scraper kit**



- Für eingebrannte Beläge an Auspuff, Bremsen, etc.
- Klingen mit 2 Schabkanten
- Arbeitet als Druck- und Zugklinge
- Ergonomischer Handgriff

**Nr. 268 220 Hartmetall Schaber Satz**  
Code: OE68000068

**XL HARTMETALL SCHABER SATZ**  
XL CARBIDE SCRAPER KIT



**Mueller's gasket; corrosion and carbon scraper**

- Double edge blade
- Extremely durable due to high quality carbide inserts
- Works as pull or push tool
- Ergonomic hand grip
- Removes paint and glue in hard to reach areas
- Removes burned in corrosion on brakes
- Carbon on exhaust manifold etc.

**XL Carbide Scraper kit**



- Für eingebrannte Beläge an Auspuff, Bremsen, etc.
- Klingen mit 2 Schabkanten
- Arbeitet als Druck- und Zugklinge
- Ergonomischer Handgriff

**Nr. 268 320 XL Hartmetall Schaber Satz**  
Code: OE78000078

## SCHABMEIßEL-SATZ CHISEL SCRAPER KIT

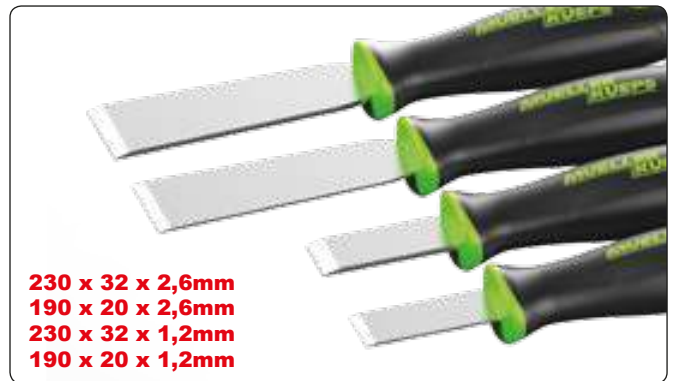

230 x 32 x 2,6mm  
190 x 20 x 2,6mm  
230 x 32 x 1,2mm  
190 x 20 x 1,2mm

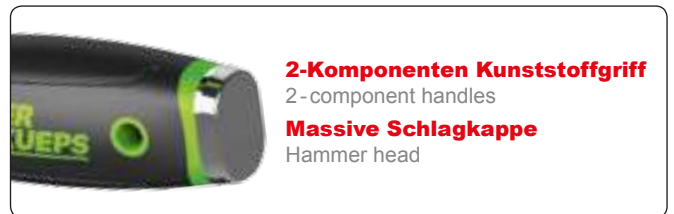

**2-Komponenten Kunststoffgriff**  
2 - component handles  
**Massive Schlagkappe**  
Hammer head



**Durchgehende, rostfreie Edelstahlklinge.** Nachschleifbar. 2-Komponenten-Kunststoffgriff. Massive, fest mit der Klinge verbundene Schlagkappe. 4-teiliger Satz bestehend aus je 2 Klingienstärken und 2 Längen.

**Nr. 268 400 Schabmeißel-Satz, 4-tlg.**  
Code: OE78000078



**Stainless steel blade through handle,** easy to re-sharpen, 2-component handles, hammer head, 4pcs kit for 2 lengths + 2 thicknesses. Universal daily use.

**Chisel scaper kit, 4 pcs.**

## SCHABMEIßEL, GEBOGEN CHISEL SCRAPER, BENDED

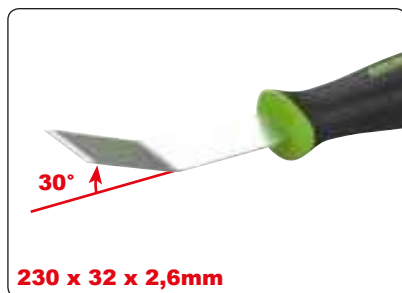

230 x 32 x 2,6mm



**Durchgehende, rostfreie Edelstahlklinge.** Nachschleifbar. 2-Komponenten-Kunststoffgriff. Massive, fest mit der Klinge verbundene Schlagkappe. Sonderausführung 30°gebogen. 230 x 32 x 2,6mm.

**Nr. 268 405 Schabmeißel, gebogen**  
Code: OE23000023



**Stainless steel blade through handle,** easy to re-sharpen, 2-component handles, hammer head, special type 30° bended. Universal daily use. 230 x 32 x 2,6mm.

**Chisel scraper, bended**

**KLINGEN-SCHABER**  
**RAZOR SCRAPER**



**Nr. 268 421**



**Nr. 268 422**

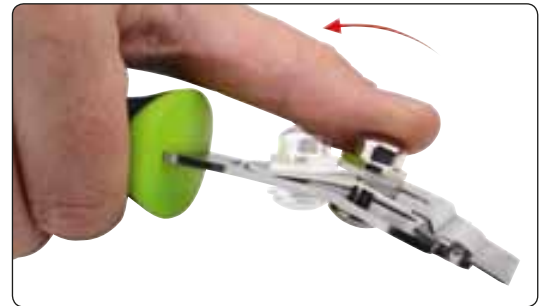

Neuartiger Glasschaber mit Klingen Schnellwechsel. Rutschfester 2-Komponenten Handgriff, Gesamtlänge: 210mm. Klingenbreite 39mm, Lieferung mit 5 Stahl- und 5 Kunststoffklingen.

**Nr. 268 420**

Code: OE248002480

**Klingen-Schaber**

Nr. 268 421/10

Code: OE680000068

Ersatzklingen Kunststoff, 10 Pack à 10 Stück

Nr. 268 422/10

Code: OE680000068

Ersatzklingen Stahl, 10 Pack à 10 Stück



New designed razor scraper with quick-lock mechanism. Non slip 2 component handle, length: 210mm. Blade: 39mm, delivered with 5 steel and 5 plastic blades.

**Razor Scraper**

Spare blades plastic, 10 pack à 10 pieces

Spare blades steel, 10 pack à 10 pieces

**UNIVERSAL-RICHTEISEN**  
**UNIVERSAL DOOR ALIGNER**



**Universal-Richteisen für sämtliche PKW-Türen** und Kofferraumklappen bei Steilheckfahrzeugen sowie alle Türen bei Kleintransportern und LKW's. Hochwertige, verchromte doppelwandige Ausführung.

**Nr. 270 006**

Code: OE106000106

**Universal-Richteisen**



**Universal door aligner for nearly all car doors,** many trunklids and all doors of vans and trucks. Chrome plated double wall construction.

**Nr. 270 006**

Code: OE106000106

**Universal door aligner**

**Lieferung inklusiv 3 verschiedener, auswechselbarer Spezialbolzen**  
Shipment includes 3 different changeable special bolts







## ZUGMESSER-SATZ PRO-XNIFE KIT



Universell einsetzbarer, massiver Messersatz z. B. für schwer zugängliche Kabelbinder, Kühlerschläuche, Kabelbäume, Teppiche, Türverkleidungen etc. Hergestellt aus hochlegierten Messerstahl.

2-Komponenten Handgriff, Hartschaumeinlage

**Nr. 268 500 Zugmesser-Satz, 3-tlg.**

Code: OE78000078



Universal use, sturdy blades for professional use. This knives are made to pull for cutting. Use at coolant hoses, wire harnesses, carpet, hard to reach zipties, cuts plastic, door panels etc. Made of high quality knife grade steel. Stays sharp longer than your average utility knife.

2-component handle, foam inlay

**Pro-Xknife kit, 3pcs.**

## TÜRFEDER-LÖSEWERKZEUG SPRING CLIP REMOVER



**Zum Entfernen und Einsetzen der Federn** (Omega Sicherungsringe) an Türgriffen und Fensterkurbeln bei Opel, Ford, BMW, Peugeot, VW usw.

**Nr. 271 001 Türfeder-Lösewerkzeug**

Code: OE11000011

**Feder an Türgriffen und Fensterkurbeln bei Opel, Ford, BMW, Peugeot, VW usw.**

Spring clips at door and window openers. Opel, Ford, BMW, VW etc.



**Remove and install spring clips** at door and window openers. Opel, Ford, BMW, VW etc.

**Spring clip remover**



**1060 x 790 x 110 mm**

## ABLAGETISCH WINDSHIELD PANEL STAND



**Breite mehrfach verstellbar** zur Aufnahme beinahe aller Scheibengrößen. Äußerst robuste Konstruktion, bis 80 kg belastbar. Die weichen, widerstandsfähigen Polster sind rutschfest und halten die Scheibe sicher in Position.

**Nr. 271 200 Ablagetisch**

Code: OE99000099



**Height + width adjustment by chain.** High quality construction, maximum load 80 kg. Soft foam pads. No assembling of parts. Packed in single carton.

**Nr. 271 200 Windshield panel stand**

Code: OE99000099

## FALZ-RICHTWERKZEUG JOIN-STRAIGHTENER

**Gesamtlänge** / Total length: **270 mm**  
**Arbeitsbreite** / Working surface width: **40 mm**  
**Schlitzbreite** / Groove width: **2 mm**  
**Schlitztiefe** / Groove depth: **20 mm**



**Mittels der Nut können Falze und Profile seitlich gerichtet werden.** Darüber hinaus eine wichtige Einpasshilfe für Motorhaube und Kofferraumdeckel.

**Nr. 272 040 Falz-Richtwerkzeug**

Code: OE460000046



**Joins and profiles can be bended sideways by using the groove.** Moreover it is an important help to fit in hoods and trunklids.

**Join-straightener**

## UMSCHLAGWERKZEUG HALBRUND BUMPING TOOL HALFROUNDED

**Gesamtlänge** / Total length: **280 mm**  
**Arbeitsbreite** / Working surface width: **90 mm**



**Ausrichten von Rundungen** z.B.: Front- oder Heckbereich, zum präzisen Umschlagen von Profilblechen.

**Nr. 272 090 Umschlagwerkzeug halbrund**

Code: OE605000050



**For fixing round pieces** i. e. in front and rear, for precise bumping profiled metal sheets.

**Bumping tool halfrounded**

## RUND-AMBOSS ROUND-ANVIL

**Gesamtlänge** / Total length: **180 mm**  
**Gewölbte Bahn Ø** / Rounded end Ø: **70 mm**  
**Gerade halbrunde Bahn** /  
Straight halfrounded end: **60 x 20 mm**



**Spezialwerkzeug zum Gegenhalten und Ausbeulen** bei gewölbten Karosserie-Konturen.

**Nr. 272 180 Rund-Amboss**

Code: OE680000068



**Especially to beat out** rounded body surfaces.

**Round-anvil**

## HANDBAUST FLACH UND GEWÖLBT DOLLY FLAT AND CURVED

**Gesamtlänge** / Total length: **190 mm**  
**Arbeitsbreite** / Width: **50 mm**  
**Höhe max.** / Height max: **30 mm**



**Zum Gegenhalten und Ausbeulen** an: Rundungen, großen Flächen, Kanten usw.

**Nr. 272 190 Handfaust flach und gewölbt**

Code: OE455004550



**To dinging** on: wide radii, flat areas, edges etc.

**Dolly flat and curved**



## PROFILRICHTBLOCK PROFIL STRAIGHTENER

- volle Schlagkraft
- für gewölbte Konturen
- für spitz zulaufende Bleche
- für große Flächen

- fully bumping power
- for rounded contours
- for sharp cornered metal sheets
- for large straight areas



**Gesamtlänge** / Total length: **135 / 360mm**  
**Außen Ø** / Outside Ø: **60mm**



**Dieses massive Werkzeug leistet hervorragende Dienste** beim kraftvollen Bearbeiten von stark deformierten Abschnitten ebenso wie bei Feinarbeiten.

**Nr. 272 135 Profilrichtblock Typ 1, 135mm**

Code: OE395003950

**Nr. 272 360 Profilrichtblock Typ 2, 360mm**

Code: OE78000078



**This tool offers great service** when used on heavy dented pieces, but can be used for small jobs also.

**Profil straightener type 1, 135mm**

**Profil straightener type 2, 360mm**

## RICHTKLOTZ-SATZ FLEXY DOLLY SET



**Lieferung in stabilem Kunststoffkoffer**  
Shipment in a rugged plastic case



**Nr. 272 222/1**  
Code: OE340000034



**Nr. 272 222/2**  
Code: OE390000039



**Nr. 272 222/3**  
Code: OE890000089



**Nr. 272 222/4**  
Code: OE490000049



**Nr. 272 222/5**  
Code: OE490000049



**Nr. 272 222/6**  
Code: OE490000049



**Nr. 272 222/7**  
Code: OE890000089



**Speziell zur Bearbeitung von Karosserien aus Stahl,** hoch und höchstfesten, extra dünnen Stahlblechen sowie Aluminiumkarossen. Richtet das Blech ohne es zu strecken oder zu schrumpfen.

**Nr. 272 217 Richtklotz-Satz, 7-tlg., im Koffer**  
Code: OE278000278



**Especially for repair work on car bodies made of steel,** high-tensile and super high-strength, extra thin steel sheets as well as aluminium bodies. Straightens the sheet without stretching or shrinking.

**Flexy dolly set in case, 7 pcs.**

## GUMMI-RICHTKLOTZ SATZ FLEXY DOLLY SET

**Massiver Stahlkern umschlossen mit einem Gummimantel. Somit wird die Auflage vollflächiger als bei herkömmlichen Stahlrichtklötzen. Ideal auch in Verbindung mit Ausbeul-Pickeisen (farblose Beulenreparatur).**

Solid steel core covered by a rubber jacket. This means that the supporting surface is greater than with traditional steel dollies. Ideal also in connection with general purpose spoon (paintless dent repairs).



**Speziell zur Bearbeitung von Karosserien aus Stahl,** hoch- und höchstfesten, extra dünnen Stahlblechen sowie Aluminiumkarossen. Richtet das Blech ohne es zu strecken oder zu schrumpfen.

**Nr. 272 222 Gummi-Richtklotz Satz, 2-tlg.**

Code: OE64000064

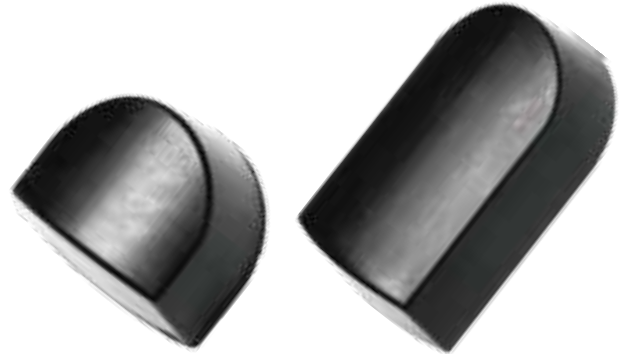

**Especially for repair work on car bodies made of steel,** high tensile and super high-strength, extra thin steel sheets as well as aluminium bodies. Straightens the sheet without stretching or shrinking.

**Flexy dolly set, 2 pcs.**

## KANTEN-RICHTWERKZEUG EDGE-STRAIGHTENER

**Gesamtlänge / Total length: 280 mm**  
**Löffelbreite / Spoon width: 100 mm**



**Türen / doors**  
**Kotflügel / fenders**  
**Motorhauben / hoods**



**Universell anwendbar zum Ausrichten von Kanten.**

**Nr. 272 280 Kanten-Richtwerkzeug**

Code: OE52000052



**Universally used to take out edges.**

**Edge-straightener**

## AUSBEULSATZ BUMPING KIT

**Gesamtlänge / Total length: 280 mm**  
**Löffelbreite / Spoon width: 100 mm**



**Gesamtlänge / Total length: 700 mm**  
**Löffelbreite / Spoon width: 60 mm**



**Gesamtlänge / Total length: 180 mm**  
**Gewölbte Bahn Ø / Rounded end Ø: 70 mm**  
**Gerade halbrunde Bahn / Straight halfrounded end: 60 x 20 mm**



**3-tlg. Ausbeulsatz** bestehend aus: Hebel- und Ausbeulwerkzeug, Rundamboss, Kantenrichtwerkzeug.

**Nr. 272 333 Ausbeulsatz, 3-tlg.**

Code: OE255000255



**Bumping kit 3 pcs.** including: bumping spoon, round anvil, edge straightener.

**Bumping kit, 3 pcs.**

## UNIVERSAL-AUSBEULSATZ UNIVERSAL PANEL BEATING KIT



**Nr. 272 413**  
Code: OE293002930

**Nr. 272 414**  
Code: OE250000025

**Nr. 272 415**  
Code: OE293002930

**Nr. 272 416**  
Code: OE250000025

**Nr. 272 417**  
Code: OE293002930

**Nr. 272 418**  
Code: OE386003860

**Nr. 272 419**  
Code: OE187001870

**Nr. 272 420**  
Code: OE320000032

**Nr. 272 421**  
Code: OE187001870



**Neuartiger Universal-Ausbeulsatz** mit auswechselbaren Schlagköpfen in verschiedenen Formen. Durch umstecken 2 unterschiedliche Arbeitstiefen. Alle Teile austauschbar. Somit absolut universelle Anwendung sowohl als reines Schlagwerkzeug (Handgriff-ALU), als auch mit dem DUO-Schlaghammer.

**Nr. 272 412 Universal-Ausbeulsatz**  
Code: OE298000298



**Brand new universal panel beating kit** with changeable beat inserts in different designs. 2 different working depths. All parts changeable. Absolutely universal use as a normal beating tool (knurled handle), or with the DUO-Sliding hammer.

**Universal panel beating kit**

## HEBEL- UND AUSBEULWERKZEUG BUMPING SPOON

**Gesamtlänge** / Total length: **700 mm**  
**Löffelbreite** / Spoon width: **60 mm**

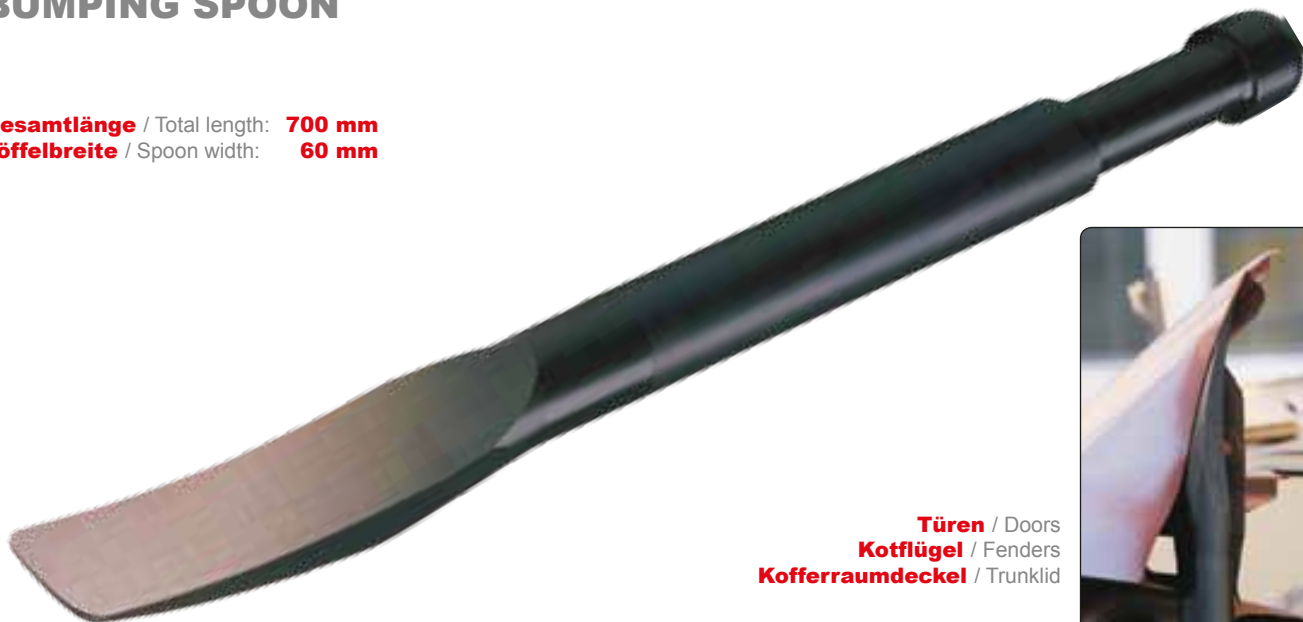

**Türen** / Doors  
**Kotflügel** / Fenders  
**Kofferraumdeckel** / Trunklid



Ideal für Arbeiten an schwer zugänglichen Stellen.

**Nr. 272 680 Hebel- und Ausbeulwerkzeug**

Code: OE148000148



Best for working on hard to reach areas.

**Bumping spoon**

## UNIVERSAL ZUGBÜGEL UNIVERSAL PULLING HOOK



**Nr. 433 450/28**  
**Doppelhaken**  
Double hook



**Nr. 433 450/29**  
**Adapter für Doppelhaken**  
Adapter for double hook



**Nr. 433 450**  
Code: OE228000228  
**Universal Gleithammer**  
Universal slide hammer



**Spezialausführung** mit verstellbarem Teleskop Kunststoff-Schiebestück für extrem tief liegende Stellen wie z. B.: Kofferraum, Ersatzradwanne, Kotflügel etc. Zum Ausbeulen von auf Spannung gezogenen Karosserieblechen. Kunststoff-Schiebestück auch für Alu- oder hochfeste Bleche geeignet.

**Nr. 272 700 Uni-Zugbügel, komplett**

Code: OE248000248

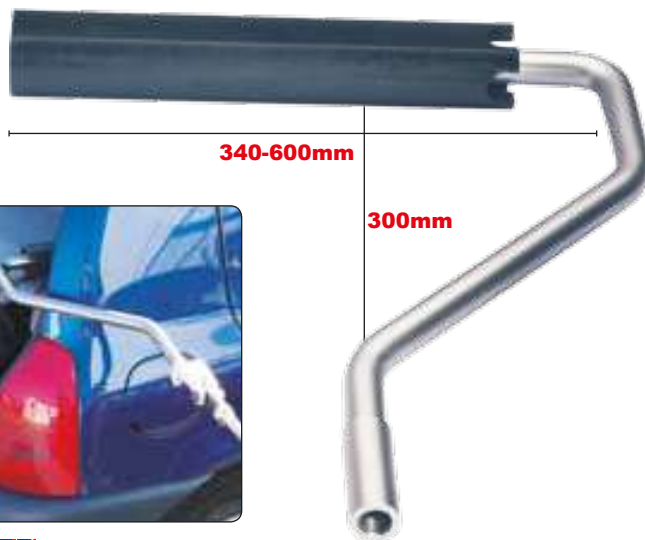

**Special design** featuring an adjustable telescopic plastic slide adapter for extremely deep areas such as e.g.: trunk, fender, spare wheel storage. For removing dents when body sheet is under tension power. Plastic slide adapter works perfect also for aluminium and high strength sheets.

**Uni pulling hook, complete**



# LKW-HEBELEISEN HEAVY DUTY PRY BAR

**Schlagfester, ergonomischer Griff**  
Ergonomic and hammer resistant



**610mm x 90°**  
**Nr. 276 301**  
Code: OE62000062

**Sonderstahl, gehärtet und vergütet**  
Special steel, hardened and tempered



**910mm x 45°**  
**Nr. 276 302**  
Code: OE68000068



**610mm x 60°**  
**Nr. 276 303**  
Code: OE68000068

**Nr. 276 310**  
**LKW-Hebeleisensatz, 4-tlg.**  
Heavy duty pry bar kit, 4 pcs.



**900mm**  
**Nr. 276 304**  
Code: OE68000068



**Massiver Schlagkopf**  
Massive punch head

**45° Sonderstahl-Klinge**  
45° special steel

**1130mm, 6-kant, gehärtet und vergütet**  
1130mm, hex, coated and hardened

**Ergonomischer "DUO-GRIFF"**  
Ergonomic "DUO-HANDLE"

**Gesamtlänge: 1150mm** Length: 1150mm

**Nr. 276 342**  
**LKW-Hebeleisen "DUO-GRIFF"**  
Heavy duty pry bar "DUO HANDLE"



**Nr. 276 340**  
Code: OE68000068  
**Wandhalterung für Hebeleisen**  
(ohne Werkzeuge)  
Steel wall rack (without tools)



**Schlagfester, ergonomischer Kunststoffgriff**, ausgelegt zur Arbeit mit 2 Händen. Durchgehende 6-Kant Sonderstahlklinge 16x16mm mit massivem Schlagkopf für höchste Beanspruchung. Gehärtet und vergütet, nachschleifbar.

**Nr. 276 310 LKW-Hebeleisen-Satz, 4-tlg.**  
Code: OE198000198

**Nr. 276 342 LKW-Hebeleisen "DUO-GRIFF"**  
Code: OE138000138



**Ergonomic, hammer resistant handle** for 2-hand use. Special steel 16x16mm going through handle, massive punch head for toughest daily work. Made for heavy duty jobs as truck, offshore.

**Heavy duty pry bar kit, 4 pcs.**

**Heavy duty pry "DUO HANDLE"**

## GELENKKOPF-HEBELEISEN SWIVEL HEAD PRY BAR



**Universell einsetzbares Hebelwerkzeug.** Gelenk-Schwenkopf in zahlreiche Positionen verstellbar. Schmales Profil ermöglicht den Einsatz der Hebeleisen an engen und schwer zugänglichen Stellen. Perfekte Einstellmöglichkeiten je nach Anforderung. Integrierter Ratschenmechanismus

**Nr. 276 321** **Schweres Teleskop-Hebeleisen**  
Code: OE168000168 **530-840mm**

**Nr. 276 323** **Schweres Teleskop-Hebeleisen**  
Code: OE198000198 **760-1270mm**

**Nr. 276 500** **Gelenkkopf-Hebeleisen-Satz, 3-tlg.**  
Code: OE112000112 **240, 320 + 390mm**

**Nr. 276 504** **Gelenkkopf-Hebeleisen XL,**  
Code: OE980000098 **620mm**

**Nr. 276 505** **Gelenkkopf-Hebeleisen XL,**  
Code: OE114000114 **880mm**

**Nr. 276 513** **Doppelgelenk-Hebeleisen**  
Code: OE680000068 **380mm**



**Universal pry bar.** Swivel head is adjustable in many positions. Useable for tight and difficult reachable spots. Perfect tool for users.

**Heavy duty extendable pry bar**  
**530-840mm**

**Heavy duty extenable pry bar**  
**760-1270mm**

**Swivel head pry bar kit, 3 pcs.**  
**240, 320 + 390mm**

**Swivel head pry bar XL,**  
**620mm**

**Swivel head pry bar XL,**  
**880mm**

**Double-joint pry bar**  
**380mm**

## MONTIEREISEN-SATZ PRY BAR KIT

### Anwendung:

- universell für Karosseriearbeiten
- Hebelwerkzeug (z.B. Auspuff)
- Lösewerkzeug (z.B. Antriebswelle)
- Bremseinstellhebel, Schaber

Can be used:

- for car body works
- lever tool
- brake caliper lever
- scraper



**200mm**  
Nr. 276 441  
Code: OE120000012

**300mm**  
Nr. 276 442  
Code: OE190000019

**450mm**  
Nr. 276 443  
Code: OE240000024

**600mm**  
Nr. 276 444  
Code: OE290000029



**Geschmiedeter 4-kant Sonderstahl** für höchste Beanspruchung. Gehärtet und vergütet. Nachschleifbar. Massiver Kunststoffgriff.

**Nr. 276 440 Montiereisen-Satz, 4-tlg.**

Code: OE390000039



**Forged square steel.** Drop forged 4-point steel. Highest claims. Hardened and tempered. Can be grinded by hand. Comfortable plastic handles.

**Pry bar kit, 4 pcs.**

## ZIERLEISTEN KUNSTSTOFFKEIL TRIM WEDGE



**Nützliches, vielseitiges Werkzeug aus Spezial-Kunststoff**, für alle Arbeiten an Zierleisten, Gummidichtungen etc. Auch zum Ausrichten von Autotüren geeignet.

**Nr. 277 001 Zierleisten-Kunststoffkeil 30mm**

Code: OE990000990

**Nr. 277 002 Zierleisten-Kunststoffkeil 60mm**

Code: OE138001380



**Useful universal tool made of special material.** For all jobs at trims, moulds, rubbers. Also for aligning jobs.

**Trim wedge 30mm**

**Trim wedge 60mm**



**Breite / Width: 30 bzw. 60 mm**  
**Länge / Length: 200 mm**



## DEMONTAGEKEIL 500mm REMOVAL WEDGE 500mm



**Zur schonenden Demontage** empfindlicher Bauteile, keine Lackbeschädigungen, ideal für Verkleidungen etc.

**Nr. 277 003 Demontagekeil 500mm**

Code: OE290000029



**For damage free removal** of door covers, trims. No scratches in plastics, no paint damage.

**Nr. 277 003 Removal wedge 500mm**

Code: OE290000029



**Länge / Length: 500 mm**



**CLIP- + SICHERUNGSZANGE**  
**PLASTIC CLIP PLIERS**



Hochwertig, spiegelpolierte Edelstahlzange, z.B. für Plastik Clips oder Sicherungen. Innovatives Design. Länge 180mm.

**Nr. 277 007 Clip + Sicherungszange**

Code: OE34000034

**Nr. 277 007/10 Clip- + Sicherungszange, 10 Stk.**

Code: OE340000340



**High quality, polished stainless steel pliers for removing plastic clips.** Innovative design provides comfortable fit in the hand. Universal use. Length 180 mm.

**Nr. 277 007 Plastic Clip Pliers**

Code: OE34000034

**Nr. 277 007/10 Plastic Clip Pliers, 10 pack**

Code: OE340000340

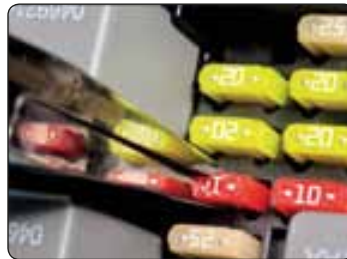

**CLIP HEBER**  
**CLIP LIFTER**



**5 mm**



**Universalwerkzeug zum Lösen der Kunststoff-Nieten, Clips etc.** Länge: 175mm, Breite: 15mm, Gummi-Handgriff.

**Nr. 277 008 Clip Heber**

Code: OE198001980



**For plastic fasteners, plastic clips, upholstery, door panels.** Length: 175mm, width: 15mm.

**Nr. 277 008 Clip Lifter**

Code: OE198001980



## CLIP HEBER SET, 5-TEILIG CLIP LIFTER SET, 5-PIECES



Nr. 277 015

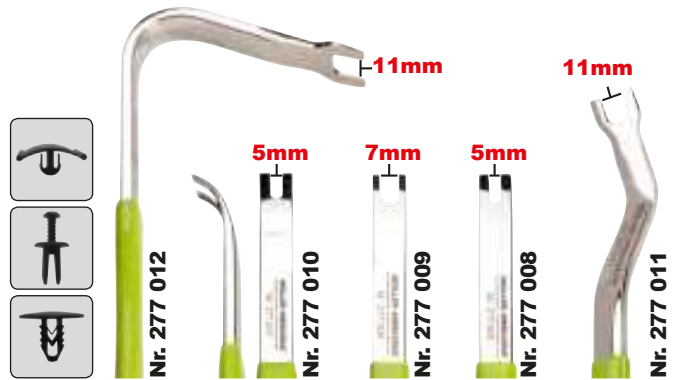

## XL-CLIP HEBER SET, 3-TEILIG XL-CLIP LIFTER SET, 3-PIECES



Nr. 277 023



Universalwerkzeug zum Lösen der Kunststoff-Nieten, Clips etc.

### Nr. 277 015 Clip Heber Set, 5-tlg.

Code: OE998000980

Nr. 277 008 Clip Heber 5mm  
Code: OE1980001980

Nr. 277 009 Clip Heber 7mm  
Code: OE1980001980

Nr. 277 010 Clip Heber 5mm, halbrund  
Code: OE1980001980

Nr. 277 011 Clip Heber 11mm, S-Form  
Code: OE1980001980

Nr. 277 012 Clip Heber 11mm, gewinkelt  
Code: OE1980001980

### Nr. 277 023 XL-Clip Heber Set, 3-tlg.

Code: OE880000088

Nr. 277 020 XL-Clip Heber S-Form, 370mm  
Code: OE340000034

Nr. 277 021 XL-Clip Heber  
Code: OE280000028

Nr. 277 022 XL-Clip Heber S-Form, 245mm  
Code: OE280000028



For plastic fasteners, plastic clips, upholstery or door panels.

### Clip Lifter Set 5pcs

Clip Lifter 5mm

Clip Lifter 7mm

Clip Lifter 5mm half-round

Clip Lifter 11mm S-Shape

Clip Lifter 11mm angled

### XL-Clip Lifter Kit 3-pcs

XL-Clip Lifter S-Shape, 370mm

XL-Clip Lifter

XL-Clip Lifter S-Shape, 245mm

### Abmessungen Dimensions

Länge length	Breite width
175mm	5 / 15mm
175mm	7 / 14mm
175mm	5 / 14mm
195mm	11 / 22mm
175mm	11 / 21mm
370mm	11mm
250mm	5mm
245mm	11mm



**KUNSTSTOFF-KOMBI KEIL / UNIVERSAL HAKEN**  
**COMBI WEDGE / UNIVERSAL HOOK**



**Nr. 277 004**  
**Länge / Length:** 200mm  
**Breite / Width:** 30mm

**Nr. 277 046**  
**Länge / Length:** 190mm



**KUNSTSTOFF-KOMBI KEIL**  
**Kombiniertes Universalwerkzeug.** Ideal z.B zum Lösen der Türclips, Hebel- und Richtarbeiten.

**UNIVERSAL HAKEN**  
**Nützliches Universalwerkzeug** z. B. für Scheibengummis, Türdichtungen, Teppiche, Innenverkleidungen. Lack- und oberflächenschonend.

**Nr. 277 047 Kunststoff-Kombi Keil und Universal Haken**  
Code: OE195001950

**Nr. 277 004 Kunststoff-Kombi Keil**  
Code: OE11000011

**Nr. 277 046 Universal Haken**  
Code: OE850000850



**COMBI WEDGE**  
**Combined universal tool.** Perfect for a variety of panel clips and molding removal.

**UNIVERSAL HOOK**  
**An ideal tool** for working on door molding and a variety of other seals.

**Combi Wedge and Universal Hook**

Combi Wedge

Universal Hook

**STUFENHEBEL**  
**STEP LEVER**



**Zum Justieren und Richten** von Türen und Scheiben. Schlagfest, griffige Oberfläche.

**Nr. 277 072 Stufenhebel**  
Code: OE19000019



**Helpfully adjusting and aligning** doors and glasses. Shok resistant, handy surface.

**Nr. 277 072 Step lever**  
Code: OE19000019



**Länge / Length:** 280mm  
**Breite / Width:** 70mm  
**Höhe / Height:** 20mm

6 Karosserie/Verschleiß AutoBody/Consumables  
 Universal-Werkzeuge Universal Tools  
 7 Transporter & LKW Heavy Duty & Trucks  
 8 Equipment  
 9 Inhaltsverzeichnis Table of Contents

## AUSBEUL-PICKEISEN-SATZ BODY-PICK KIT

**4-tlg. Satz bestehend aus folgenden Längen:**

4-pcs. kit composed of 4 different lengths:

**300, 400, 500 + 800mm**

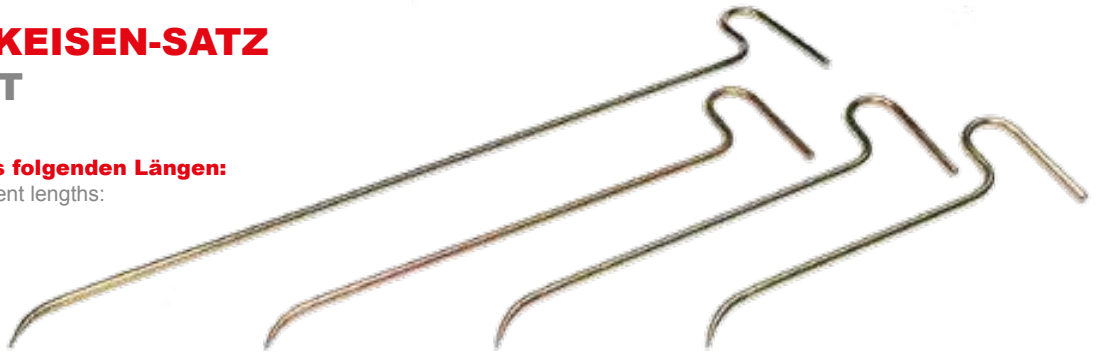

**Besonders geeignet zum punktgenauen Ausbeulen** schwer zugänglicher Karosserieteile und zur „farblosen“ Beulenreparatur. Der herkömmliche Weg mit aufwendigem Ausbeulen, Abschleifen und Lackieren wird mit diesem Werkzeug oftmals überflüssig. Handgeschmiedetes Spezialwerkzeug.

### Nr. 280 005 Ausbeul-Pickeisen-Satz, 4-tlg.

Code: OE138000138

Nr. 280 001 Ausbeul-Pickeisen 300mm

Code: OE260000026

Nr. 280 002 Ausbeul-Pickeisen 400mm

Code: OE290000029

Nr. 280 003 Ausbeul-Pickeisen 500mm

Code: OE360000036

Nr. 280 004 Ausbeul-Pickeisen 800mm

Code: OE490000049



**Especially made for an exact ding repair** on difficult to reach areas and also for paintless dent repair. The normal used process, such as ding repair, grinding and painting is often a thing of the past with this tool. Handmade specialty tool.

### Body-pick kit, 4 pcs.

Body-pick 300mm

Body-pick 400mm

Body-pick 500mm

Body-pick 800mm

## FORMPICKEISEN-SATZ BODY-PICK KIT

**Länge / Length: 500mm**

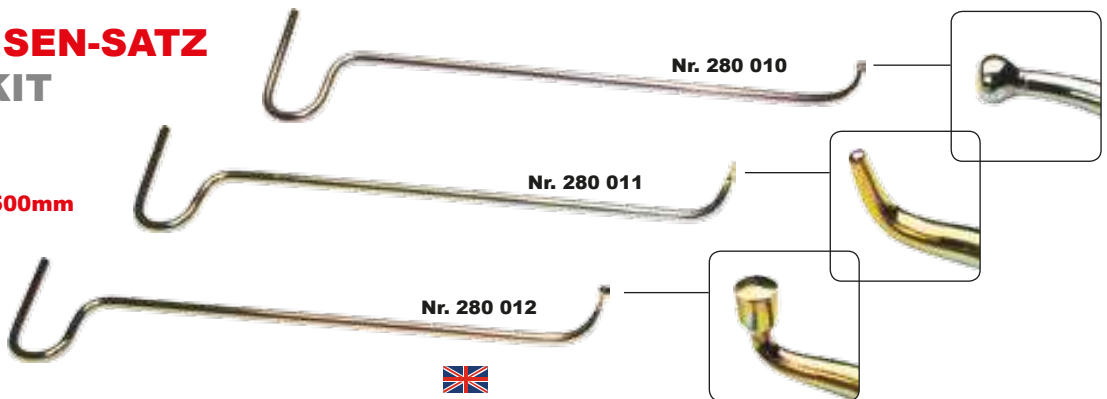

**Zur Beseitigung von: Dellen nach Steinschlag.** Exakte Bearbeitung von Sicken und Doppelblechen. Ausdrücken kleinerer Dellen nach Hagelschlag. Ausdrücken von Dellen nach Türschlag.

### Nr. 280 013 Formpickeisen-Satz, 3-tlg.

Code: OE141000141

Nr. 280 010 Formpickeisen

Code: OE496004960

Nr. 280 011 Formpickeisen

Code: OE450000045

Nr. 280 012 Formpickeisen

Code: OE505005050



**Elimination of stone throw dents.** Exact work on edges, double sheets. Elimination of dents damaged by hail. Ding repair of small dents on the door.

### Body-pick kit, 3 pcs.

Body-pick

Body-pick

Body-pick

## FORMPICKEISEN-SATZ BODY PICK KIT

Länge / Length: 500mm

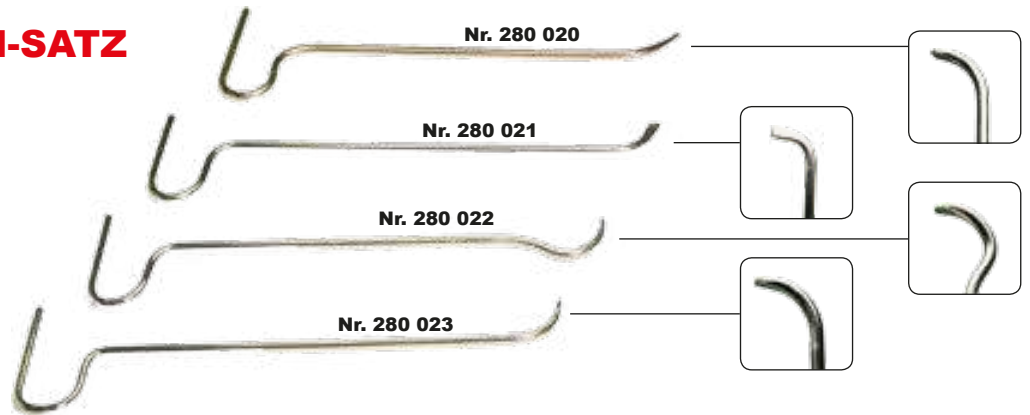

**Beseitigung von Dellen nach Steinschlag.** Exakte Bearbeitung von Sicken, Doppelblechen. Ausdrücken kleinerer Dellen nach Hagelschlag. Ausdrücken von Dellen nach Türschlag.

### Nr. 280 024 Formpickeisen-Satz, 4-tlg.

Code: OE174000174

Nr. 280 020 Formpickeisen

Code: OE430000043

Nr. 280 021 Formpickeisen

Code: OE430000043

Nr. 280 022 Formpickeisen

Code: OE500000050

Nr. 280 023 Formpickeisen

Code: OE430000043



**Elimination of stone throw dents.** Exact work on edges, double sheets. Elimination of dents damaged by hail. Ding repair of small dents on the door.

### Body-pick kit, 4 pcs.

Body-pick

Body-pick

Body-pick

Body-pick

## AUSBEUL- & FORMPICKEISEN-SATZ BODY-PICK KIT



Nr. 280 005



Nr. 280 024



Nr. 280 013



### Nr. 280 007 Ausbeul- & Formpickeisen-Satz, 7-tlg.

Code: OE269000269

(Nr. 280 005 und Nr. 280 013)

### Nr. 280 111 Ausbeul- & Formpickeisen-Satz, 11-tlg.

Code: OE420000420

(Nr. 280 005, Nr. 280 013 und Nr. 280 024)



### Body-pick kit, 7 pcs.

(no. 280 005 and no. 280 013)

### Body-pick kit, 11 pcs.

(no. 280 005, no. 280 013 and no. 280 024)



## AUSBEULWERKZEUGSATZ BUMPING TOOL KIT



**Splitter- und bröckelfrei.** Kein Formenbau erforderlich. Lackschonendes Ausrichten.

### Nr. 282 001 Ausbeulwerkzeugsatz, 3-tlg.

Code: OE660000066

Nr. 282 002

Code: OE222002220

Nr. 282 003

Code: OE100000010

Nr. 282 004

Code: OE350000035

Kunststoff-Türrichtklotz

Kunststoff-Körner

Kunststoff-Kantenrichtblock



**No splinter.** No own designing of bumping tools. No paint damage by aligning possible.

### Bumping tool kit, 3 pcs.

Plastic door aligner

Plastic center punch

Profile straightener

## KUNSTSTOFFHAMMER PICK & FINISHING HAMMER

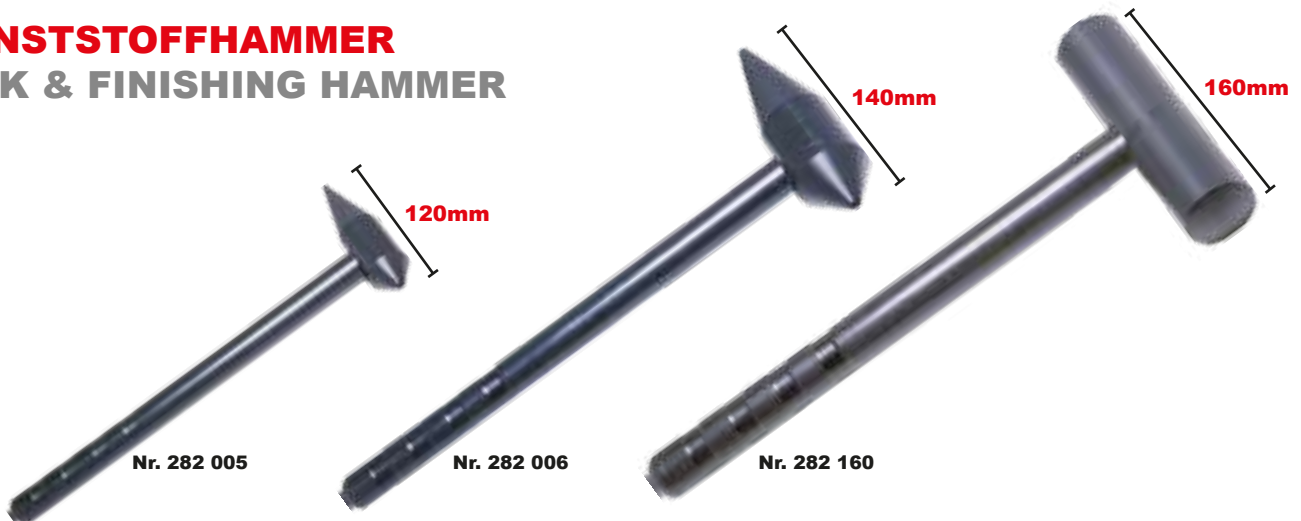

**Für präzise und leichte Richtarbeiten.**

### Nr. 282 005 Kunststoffhammer 120mm, Ø 30mm

Code: OE340000034

### Nr. 282 006 Kunststoffhammer 140mm, Ø 40mm

Code: OE345003450

### Nr. 282 160 Kunststoffhammer 160mm, Ø 40mm

Code: OE390000039



**For precise and easily working.**

### Pick-hammer 120mm, Ø 30mm

### Pick-hammer 140mm, Ø 40mm

### Pick-hammer 160mm, Ø 40mm

## DL-BANDSCHLEIFER AIR BELT GRINDER



**Schleifband Breite: 10mm x 330mm**  
Belt width: 10mm x 330mm

<b>MÜLLER-WERKZEUG</b> Technische Daten / technical information		
<b>Gewicht / weight</b>	kg	0,90
<b>Länge / length</b>	mm	315
<b>Anschlussgewinde / air nipple</b>	Zoll	1/4"
<b>Schlauchanschluss / air hose</b>	mm	9-13
<b>Luftverbrauch / air consumption</b>	l/min	85
<b>Drehzahl/min / rpm</b>	Rpm	25.000
<b>Arbeitsdruck / air pressure</b>	bar	6,3
<b>Geräuschpegel / sound level</b>	dB	82



**Universell einsetzbare Druckluftmaschine z. B. für Schweißnähte, Punktschweißungen, Hartlötstellen, Entrosten, Entgraten etc. in Karosseriebau, Lackiererei, PKW-Werkstatt, LKW-Werkstatt, Industrie. Durch drehbaren Handgriff auch an verwinkelten, schwer zugänglichen Stellen einsetzbar.**

### Nr. 290 165 DL-Bandschleifer komplett mit 15 Schleifbändern

Code: OE198000198

Nr. 290 040 Code: OE580000058	Ersatzschleifband K-40 (VPE 25 Stück), braun
Nr. 290 060 Code: OE580000058	Ersatzschleifband K-60 (VPE 25 Stück), braun
Nr. 290 080 Code: OE580000058	Ersatzschleifband K-80 (VPE 25 Stück), braun
Nr. 290 120 Code: OE640000064	Ersatzschleifband K-120 (VPE 25 Stück), braun
Nr. 290 041 Code: OE590000059	Spezierschleifband K-40 (VPE 25 Stück), grün
Nr. 290 061 Code: OE590000059	Spezierschleifband K-60 (VPE 25 Stück), grün
Nr. 290 081 Code: OE590000059	Spezierschleifband K-80 (VPE 25 Stück), grün
Nr. 290 121 Code: OE680000068	Spezierschleifband K-120 (VPE 25 Stück), grün



**Universal use for welding seams, spot welds, soldered connections, rust, de-burring at body shops, truck shops, paint shops, industry. Swivelling belt finger for narrow spaces.**

### Air Belt Grinder complete with 15 belts

Replacement belt K-40 (package 25 pcs.), brown
Replacement belt K-60 (package 25 pcs.), brown
Replacement belt K-80 (package 25 pcs.), brown
Replacement belt K-120 (package 25 pcs.), brown
Special belt K-40 (package 25 pcs.), green
Special belt K-60 (package 25 pcs.), green
Special belt K-80 (package 25 pcs.), green
Special belt K-120 (package 25 pcs.), green

# DL-STABSCHLEIFER AIR DIE GRINDER

## BIONIGRIP

**Präzisions-Spannzange 6,0 mm**  
precision collet 6.0 mm

**spannt auch Vollhartmetall**  
can be used also for carbide

**stufenlose Drehzahleinstellung**  
stepless trigger



MÜLLER-WERKZEUG Technische Daten / technical information		
Gewicht / weight	Kg	0,5
Länge / length	mm	175
Präzisions-Spannzange / precision collet	mm	6
Drehzahl / free speed	RPM	24.000
Gewinde / air inlet	NPT	1/4"
Schlauch / hose	mm	min. 10
Luftverbrauch / air consumption	l/min	116



 Verschiedene Hochleistungs-Mini-Trennscheiben, Bohrung 10mm

 Various high performance Mini cut off discs, 10mm bore

**Nr. 110 400** Trennscheibensortiment, 9tlg.  
Code: OE38000038 **Cut off disc kit, 9pcs.**



 **Sehr starkes 0,75 PS Composit-Gerät der neuesten Generation.** Maximale Rundlaufgenauigkeit durch Präzisions-Spannzange, minimale Vib ration, Fräser „schlägt“ weniger zurück, geringer Geräuschpegel, maximale Leistung, perfektes Handling durch neuartige Bionigrip Oberfläche. Abluft nach hinten. Präzisions-Industriespannzange 6,0mm anstatt wie üblich 1/4". Somit spannen z. B. Hartmetallfräser auf die gesamte Länge. Besserer Rundlauf. Läuft ruhiger.

**Nr. 297 004 DL-Stabschleifer "BIONIGRIP"**  
Code: OE108000108

 **Very strong 0.75 HP - Latest generation of composite tools.** Maximum concentricity via its precision collet, minimal vibration, less "kick back" from cutters, low noise level, maximum power, perfect handling due to its new Bionigrip handle surface. Air exhaust to the rear.

Precision Industry Collet 6.0 mm instead of the usual 1/4". Therefore clamp carbide cutters over the entire length. Improved concentricity. Runs quieter.

**Air Die Grinder "BIONIGRIP"**

**DL-STABSCHLEIFER 90°**  
**AIR DIE GRINDER 90°**

**BIONIGRIP**



**Präzisions-Spannzange 6,0 mm**  
precision collet 6.0 mm

**spannt auch Vollhartmetall**  
can be used also for carbide

**stufenlose Drehzahleinstellung**  
stepless trigger

<b>MÜLLER-WERKZEUG</b> Technische Daten / technical information		
<b>Gewicht / weight</b>	Kg	0,82
<b>Länge / length</b>	mm	177
<b>Präzisions-Spannzange / precision collet</b>	mm	6
<b>Drehzahl / free speed</b>	RPM	24.000
<b>Gewinde / air inlet</b>	NPT	1/4"
<b>Schlauch / hose</b>	mm	min. 10
<b>Luftverbrauch / air consumption</b>	l/min	116



**Sehr starkes 0,75 PS Composit-Gerät der neuesten Generation.** Maximale Rundlaufgenauigkeit durch Präzisions-Spannzange, minimale Vibration, Fräser „schlägt“ weniger zurück, geringer Geräuschpegel, maximale Leistung, perfektes Handling durch neuartige Bionigrip Oberfläche. Abluft nach hinten.

Präzisions-Industriespannzange 6,0mm anstatt wie üblich 1/4". Somit spannen z. B. Hartmetallfräser auf die gesamte Länge. Besserer Rundlauf. Läuft ruhiger.

**Nr. 297 005 DL-Stabschleifer "BIONIGRIP" 90°**  
Code: OE118000118

**Nr. 106 500**  
Code: OE198000198

**Hartmetallfräser-Satz**  
Carbide Cutter Kit

**Für Druckluftschleifer ab 20.000 U/min.**

For use of air grinder from 20.000 rpm



**Very strong 0.75 HP - Latest generation of composite tools.** Maximum concentricity via its precision collet, minimal vibration, less "kick back" from cutters, low noise level, maximum power, perfect handling due to its new Bionigrip handle surface. Air exhaust to the rear.

Precision Industry Collet 6.0 mm instead of the usual 1/4". Therefore clamp carbide cutters over the entire length. Improved concentricity. Runs quieter.

**Air Die Grinder "BIONIGRIP" 90°**

# 1PS DRUCKLUFT-TIEFENSCHNEIDER

## 1HP EXTENDED AIR CUTTER



**Kälteisolierter Handgriff**  
cold insulated handle

**Vibrationsarm**  
vibration reduced

**Spindelblockierung durch Druckknopf**  
Integrated locking button for disc change

**Für Trennscheiben bis 100 x 1,0 x 10 mm**  
Disc sizes 100 x 1.0 x 10 mm

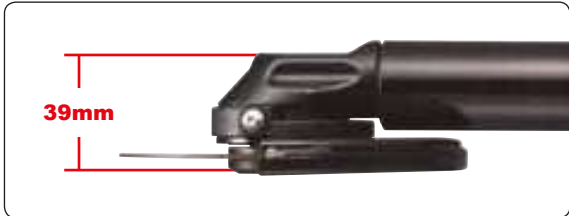

**Geringe Bauhöhe, geeignet für beengten Einsatz**  
extra slim construction for limited access areas



**Nr. 101 100**  
Code: OE38000038  
**Ersatz-Trennscheiben Ø 100mm, 10 Stk.**  
Replacement Cutting discs Ø 100mm, 10 pcs.

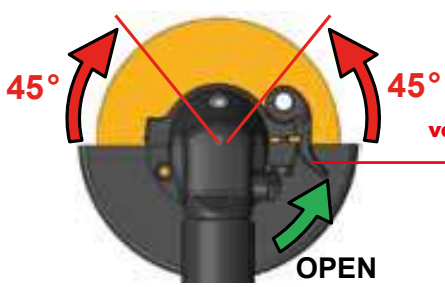



**Werkzeuglose Schnellverstellung der Schutzhaube durch Druckknopf**  
Disc protection can be locked without tools as well

**OPEN**

<b>MÜLLER-WERKZEUG</b> Technische Daten / technical information		
Schneidrad / cutting wheel	mm	100
Länge / length	mm	345
Drehzahl / free speed	RPM	14.000
Anschlussgewinde / connecting thread	Zoll	1/4"
Schlauch / air hose	mm	10
Luftverbrauch / avg air cons	CFM	4.1



 Für schwer zugängliche, tiefliegende Stellen wie z. B. am Auspuff, Verschraubungen, Gummilager, Krümmer etc.

 For restricted access as exhaust system, manifold, bushing bolts etc.

**Nr. 297 008 1PS Druckluft-Tiefenschneider**  
Code: OE238000238

**1HP Extended Air Cutter**

**STABRADIERER**  
**AIR ERASER**

**BIONIGRIP**



Speziell zur Verwendung mit diesen Scheiben abgestimmter Getriebe-Druckluftschleifer mit 1 PS Leistung. Hervorragend zur **Entfernung von Aufklebern, Zierstreifen, TÜV-Plaketten, Farbspritzern** auf Lacken. Verwendung von Schabern oder Heißluftföhn entfällt. Scheibe Ø 100 x 15 mm.

**Nr. 297 010 Stabradierer** komplett mit 1 Radierscheibe Ø 100mm  
Code: OE128000128

Nr. 297 011 Radierscheibe Ø 100mm einzeln  
Code: OE140000014

Nr. 297 111 Radierscheiben Ø 100mm 10 Stk.  
Code: OE133000133 + 1 Adapter für Bohrmaschine



Especially for use with discs designed for air grinders with 1 HP power. Also excellent for **removing stickers, decorative strips**, splashes of color on paint. No longer necessary to use scrapers or heat gun. Disc diameter 100 x 15 mm.

**Air Eraser** complete with 1 erasing disc Ø 100mm

Erasing disc Ø 100mm separate

Erasing discs Ø 100mm 10 pcs.  
+ 1 adaptor for drills

**FELGEN-RADIERSCHEIBE**  
**CONICAL ERASER FOR RIMS**

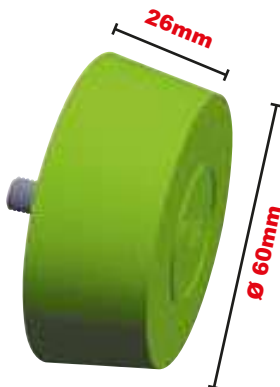

Konische Radierscheibe zum Entfernen der Kleberückstände von Auswuchtgewichten. Zur Verwendung mit Stabradierer Nr. 297 010 etc..

**Nr. 282 260 Felgen-Radrierscheibe**  
Code: OE980000980



Conical eraser disc to remove the adhesives of wheel weights. For use with air eraser no. 297 010.

**Conical eraser for rims**

**ADAPTER**



**Nr. 297 013**  
Code: OE780000780

**Adapter für Bohrfutter**

passend für  
Nr. 297 011 + Nr. 282 260



**Nr. 297 013**  
Code: OE780000780

**Adapter for Drill-Chuck**  
fits for no. 297 011 + no. 282 260

## EINSTELLWERKZEUG FÜR SPRITZDÜSEN ADJUSTING TOOL FOR SPRAYING NOZZLE



**Teleskop-Magnetheber, 650mm**  
Telescopic magnetic pick up, 650mm



**Zum Einstellen der Düsen von Scheiben-Waschanlagen.** Das ausgezogene Teleskop zeigt die Strahlrichtung. Auch als starker Teleskop-Magnetheber zu verwenden.

**Nr. 350 004 Einstellwerkzeug für Spritzdüsen**  
Code: OE850000850



**For adjusting the spraying nozzle.** The extended telescop shows the direction. Can be used as magnet pick up tool.

**Adjusting tool for spraying nozzle**

## WISCHERARM-REPARATURSATZ WIPER ARM REPAIR KIT



**Spezialwerkzeug zur Reparatur von fest-oxidierten Wischerarmgestängen.** Lieferung in übersichtlicher Kunststoffbox.

**Nr. 350 350 Wischerarm-Reparaturatz,**  
Code: OE112000112  
Golf 4, Audi A3, Seat, Skoda

**Nr. 350 354 Wischerarm-Reparaturatz,**  
Code: OE138000138  
VW Sharan, Ford Galaxy,  
Seat Alhambra



**Special tool for oxidized wiper arms.**  
Shipment in a stabil box.

**Nr. 350 350 Wiper arm repair kit,**  
Code: OE112000112  
Golf 4, Audi A3, Seat, Skoda

**Nr. 350 354 Wiper arm repair kit,**  
Code: OE138000138  
VW Sharan, Ford Galaxy,  
Seat Alhambra



**UNIVERSAL-ABZIEHSYSTEM**  
**UNIVERSAL PULLING SYSTEM**

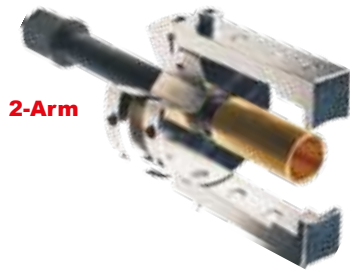

**2-Arm**



**3-Arm**

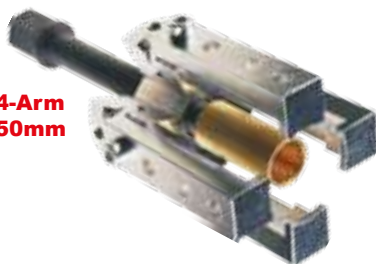

**4-Arm  
50mm**



**5-Arm  
100mm**



**Universal Abziehsystem** z.B für vordere und hintere Wischerarme bei nahezu allen Fahrzeug-Typen. Anwendung auch bei Spritzanlagen - Heckwischern. Demontage von kleineren Lagereinheiten, z. B. Anlasser, Lichtmaschine, Klimaanlagekompressor, Servolenkungspumpe o. ä.

**Nr. 350 500 Universal-Abziehsystem**

Code: OE298000298



**Fits for example for front and rear wishbones** for nearly all cars. Can be used as well rear wishbones with wiper nozzles. Also a universal solution for small bearings, air condition parts, servo steering pump...

**Universal pulling system**



# SYSTEMANWENDUNGEN UNIVERSAL GLEITHAMMER

## SYSTEM APPLICATIONS UNIVERSAL SLIDE HAMMER



**537 710**  
**Antriebswellen-Trenner M16x1,5**  
Drive shaft separator M16x1.5



**433 433 + 433 450/14**  
**MÜLLER Universal Flansch + Adapter zur Radnabenmontage**  
MUELLER Universal flange and adapter for wheel hub mounting



**gesenkgeschmiedet**  
drop forged



**433 450/25**  
**Adapter für Doppelhaken**  
Adapter for double hook



**433 450/28**  
**Universal Doppelhaken für Karosserie**  
Universal double hook for bodywork

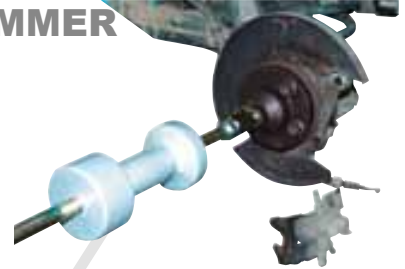

**433 450/4**  
**VW T4 Radnabe hinten mit vorhandenem Flansch + Adapter**  
VW T4 wheel hub with existing flange and adapter

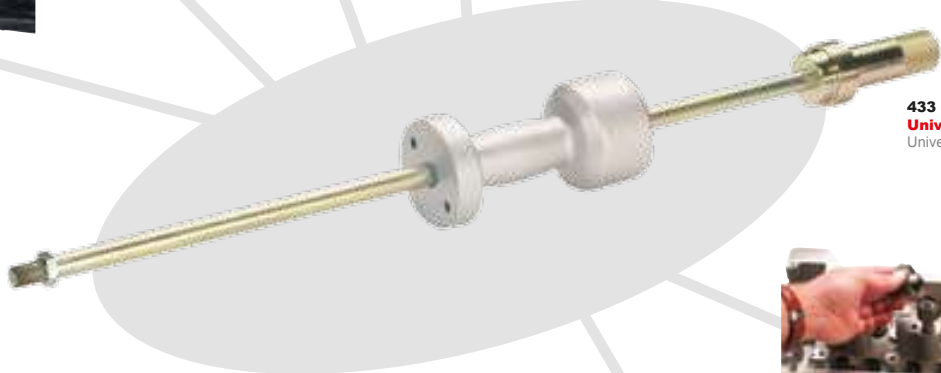

**433 450/V2**  
**Universal Gleithammer**  
Universal Slide Hammer



**600 122**  
**Injektorenzuziehler DB CDI Motoren**  
Injector puller DB CDI motors



**433 450/27**  
**Ford Mondeo Demontage Querlenker (auch DB Vito)**  
De-mounting Ford Mondeo lower suspension arm (also DB Vito)

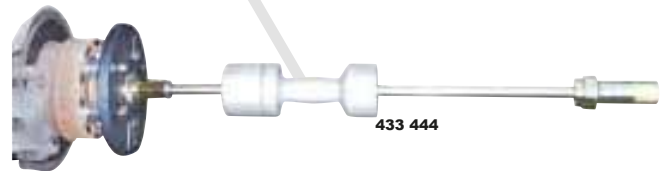

**433 444**

### Adapter mit Innengewinde M20x1,5 für MÜLLER Gleithammer

Adapter with inner thread M20x1.5 for MUELLER slide hammer

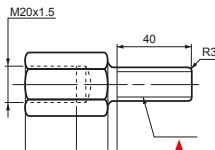

- Nr. 433 450/4** Code: OE380000038  
Außengewinde / outside thread M16x2,0
- Nr. 433 450/6** Code: OE380000038  
Außengewinde / outside thread M18x2,5
- Nr. 433 450/8** Code: OE380000038  
Außengewinde / outside thread M18x1,5
- Nr. 433 450/10** Code: OE380000038  
Außengewinde / outside thread M20x2,5
- Nr. 433 450/11** Code: OE380000038  
Außengewinde / outside thread M20x2,0
- Nr. 433 450/14** Code: OE380000038  
Außengewinde / outside thread UN1 1/2"
- Nr. 433 450/16** Code: OE380000038  
Außengewinde / outside thread M42x2 z. B. KL

**Nr. 433 450/25** Code: OE380000038  
Adapter z. B. für Doppelhaken / Adapter e. g. for double hook

**Nr. 433 450/27** Code: OE980000098  
Ausziehbügel M20x1,5 Kugelgelenke / Karosserie  
Massive, gesenkgeschmiedete Ausführung, auch z.B für Karosseriearbeiten geeignet.  
Universal hook M20x1.5 for balljoints, bodywork  
Durable, drop-forged tool. Can be used as well for car-body works.

**Nr. 433 450/28** Code: OE880000088  
Doppelhaken / double hook

### Adapter für bereits vorhandene Schlaggewichte mit anderen Gewinden

Adapter for existing slide hammers with other threads

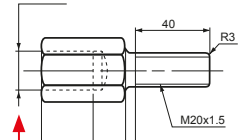

- Nr. 433 450/45** Code: OE380000038  
Innengewinde / inner thread UNC 5/8"
- Nr. 433 450/46** Code: OE380000038  
Innengewinde / inner thread M16x2,0
- Nr. 433 450/48** Code: OE380000038  
Innengewinde / inner thread M18x2,5
- Nr. 433 450/49** Code: OE380000038  
Innengewinde / inner thread M18x1,5
- Nr. 433 450/50** Code: OE380000038  
Innengewinde / inner thread M20x2,5
- Nr. 433 450/51** Code: OE380000038  
Innengewinde / inner thread M20x2,0

## TÜREINSTELLSCHLÜSSEL DOOR HINGE WRENCH

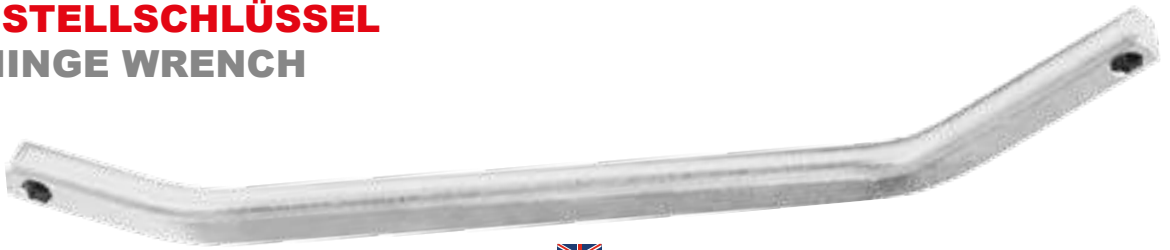

**Türeinstellschlüssel** für 5/16" Bits. M10 + TX 45 für Golf III, Vento, Audi, Seat etc.

**Nr. 514 100 Betätigungsschlüssel für 5/16" Bits**  
Code: OE320000032

**Nr. 514 110 Türeinstellschlüssel M10**  
Code: OE380000038

**Nr. 514 145 Türeinstellschlüssel TX45**  
Code: OE380000038



**Door hinge wrench** for 5/16" bits. M10 + Tx45 fits for Golf III, Vento, Audi, Seat etc.

**Special wrench bits 5/16"**

**Door Hinge wrench M10**

**Door Hinge wrench TX45**

## SPUR- & TÜRSCHARNIERSATZ WHEEL CAMBER & DOOR HINGE KIT



**M8**

**Nr. 514 333/M8**  
Code: OE108001080



**M10**

**Nr. 514 333/M10**  
Code: OE108001080



**M12**

**Nr. 514 333/M12**  
Code: OE108001080



**T30**

**Nr. 514 333/T30**  
Code: OE108001080



**T40**

**Nr. 514 333/T40**  
Code: OE108001080



**T45**

**Nr. 514 333/T45**  
Code: OE108001080



**T50**

**Nr. 514 333/T50**  
Code: OE108001080



**Spezial-Werkzeugsatz** zum Betätigen der sehr schwer zugänglichen Schrauben an den Türscharnieren oder Spureinstellungen z.B. bei VW, Audi, Seat, Skoda, Mercedes, Renault. Satz komplett im Holzkasten. Spezial-Bits in kürzest möglicher Bauweise. Passend für Torx TX30, 40, 45, 50 und Vielzahn M8, 10, 12.

**Nr. 514 333 Spur- & Türscharniersatz**  
Code: OE875008750



**Special kit** for hard to reach screw connections as on door hinges or wheel camber: VW, Audi, Seat, Skoda, Mercedes, Renault. Kit comes in wooden box. Special Bits in shortest possible length. Fit for Torx TX30, 40, 45, 50 and spline M8, 10, 12. Extra short ratchet, 5/16".

**Wheel camber & door hinge kit**

## AIRBAG-LÖSEWERKZEUG V.A.G. AIRBAG-TOOL V.A.G.



**Kombiniertes Spezialwerkzeug** zur Demontage der Airbag-Einheit. Anwendung von hinten in den Lenkradkörper. Entriegelung des innen liegenden Federringes. Anwendung z.B. bei VW Golf 4, Passat B5, Polo, Lupo, Bora, Beetle, Seat, Skoda etc.

**Nr. 604 785 Airbag-Lösewerkzeug V.A.G.**

Code: OE19000019

**Nr. 604 785/3 Airbag-Lösewerkzeug V.A.G., 3-tlg.**

Code: OE56000056



**Combined special tool** for demounting the airbag unit. Use from backside into the steering wheel housing. Delocks the inner spring ring. Can be used at VW Golf 4, Passat B5, Polo, Lupo, Beetle, Seat, Skoda etc.

**Airbag-tool V.A.G.**

**Airbag-tool V.A.G., 3 pcs.**



## SCHEIBENWERKZEUG-SATZ WINDOW-TOOL



**Ziehgriff**

Square wire handle short

**Nr. 700 139**

Code: OE24000024



**Draht-Durchführsonde**

Wire starter

**Nr. 700 140**

Code: OE14000014



**4-kant Draht 50m Rolle**

Square wire 50m

**Nr. 700 150**

Code: OE198001980



**Gegenhalte-Ziehgriff**

Square wire handle long

**Nr. 700 165**

Code: OE44000044



**Zierleistenkeil**

Trim Wedge

**Nr. 277 001**

Code: OE990000990



**Universal-Haken**

Universal-hook

**Nr. 277 046**

Code: OE850000850



**Zummühelessen Austrennen geklebter Autoscheiben.** Satz bestehend aus: Ziehgriff, Gegenhalte-Ziehgriff, Universal-Haken, Zierleistenkeil, Vierkant-Schneidedraht und Draht-Durchführsonde.

**Nr. 700 161 Scheibenwerkzeug-Satz**

Code: OE153000153



**To remove bonded car-windows.** Set includes square wire handle short, square wire handle long, wire starter, square wire 50m, trim wedge and universal-hook.

**Window-Tool**

**WERKSTATT-SERVICE-WAGEN**  
**GARAGE SERVICE CART**



**Werkstatt-Service Wagen mit hoher Ablagefach-Last.** Oberes Ablagefach bis max. 135 Kg belastbar. Mittleres und unteres Ablagefach bis max. 45 Kg belastbar. Stabile, kugellagerte und drehbare Leichtlauf-Rollen.

**Nr. EQ-370 Werkstatt-Service-Wagen**  
 Code: OE178000178



**Garage-service cart with high load capacity.** Top shelf max. 135 Kg. Middle and bottom shelf max 45 Kg. Turnable casters with ball bearings.

**Garage service cart**



**MÜLLER Tipp:**  
elektronisches Dokument  
Artikelsuche mit "Strg + F"

**MUELLER Tip:**  
electronic document  
Product Search "Ctrl + F"

**Apple:** "⌘ + F"



# UNIVERSAL-WERKZEUGE UNIVERSAL TOOLS



**CHANNEL LOCK** **ÖLFILTERZANGE**  
**OIL FILTER PLIER**



**CHANNELLOCK Ölfilterzangen zum Lösen festsitzender Ölfilter.** Spezial-Zahnung. Ab-solut universelle Anwendung. 2-teiliger Satz bestehend aus 300 und 400mm Zange.

**Nr. CHA-OF-1 Ölfilterzange**

Code: OE936009360



**CHANNELLOCK oil filter plier.** Special teeth grip for perfect loosen the oilfilter. Universal application, 300 and 400mm.

**Oil Filter Plier**



**CHANNEL LOCK** **BREMSEN ZANGE**  
**BRAKE PLIER**



**Perfekt zum Lösen** beschädigter Schraubenköpfe, Muttern, Stehbolzen, überdrehter Überwurfmutter, Bremsleitungen, Entlüfterschrauben. Diese Zange beißt sich bei Belastung immer weiter fest. Länge 175mm, Öffnung bis 20mm.

**Nr. CHA-307 Bremsen Zange**

Code: OE381003810



**Perfect for loosening** damaged screw heads, nuts, bolts, rounded union nuts, brake lines, bleed screws. These pliers bite firmly under load and grip tightly. Length 175mm, opening up to 20mm.

**Brake plier**

**CHANNEL LOCK** **SPURSTANGEN-ZANGENSATZ**  
**TIE ROD PLIER KIT**



**Selbstspannend,** universell passend. 2tlg. 240 / 350mm

**Nr. CHA-410/414 Spurstangen-Zangensatz, 2-tlg.**

Code: OE11301011301



**Plier kit 2pcs** self clamping, fits universally. 240 / 350 mm

**Tie rod plier kit, 2 pcs.**



## US-WASSERPUMPENZANGE PLIER



**Nr. CHA-424 US-Wasserpumpenzange 114mm**

Code: OE352203522



**Plier 114mm**

**Nr. CHA-426 US-Wasserpumpenzange 165mm**

Code: OE236002360

**Plier 165mm**

**Nr. CHA-421 US-Wasserpumpenzange 240mm**

Code: OE430004300

**Plier 240mm**

**Nr. CHA-440 US-Wasserpumpenzange 300mm**

Code: OE440000044

**Plier 300mm**

**Nr. CHA-460 US-Wasserpumpenzange 420mm**

Code: OE720000072

**Plier 420mm**

**Nr. CHA-480 US-Wasserpumpenzange 510mm**

Code: OE110000110

**Plier 510mm**



## UNIVERSAL ZANGE AIR BRAKE PLIER



**Universal Zange, 300mm.** Ideal geeignet z. B. zum Überprüfen des Bremsgestänges bei Druckluft-Bremsanlagen.



**Universal Plier 300mm,** universal application, e.g. checking air brakes on trucks.

**Nr. CHA-444 Universal Zange, 300mm**

Code: OE485704857

**Universal plier, 300mm**



## US-SEITENSCHNEIDER CUTTING PLIER



**Seitenschneider mit sehr hoher Schneidkraft.** Laser-gehärtete Schneiden.



**Cutting pliers with high leverage.** Curved diagonally. Special hardened jaw.

**Nr. CHA-447 US-Seitenschneider 200mm**

Code: OE590000059

**Cutting Plier 200mm**

**Nr. CHA-449 US-Seitenschneider 250mm**

Code: OE670000067

**Cutting Plier 250mm**



**SICHERUNGSRINGZANGEN**  
**RETAINING RING PLIERS**



**Nr. CHA-RT-3**



**Nr. CHA-929**

**mit Ratschen- /  
Feststellfunktion**  
with ratchet / lock mechanism



**Nr. CHA-927**



- Umschaltbar für Innen + Außenringe
- Hochwertige, langlebige Konstruktion
- Lieferung mit Spitzen gerade + 90°

**Nr. CHA-RT-3 Universal Sicherungsring Zangen Satz**, 3 Zangen + 15 Satz Greifspitzen komplett in einer Box  
Code: OE228000228

Nr. CHA-926 für Ringe ab ca. 4 - 25mm

Nr. CHA-927 für Ringe bis 50mm  
Code: OE64000064

Nr. CHA-929 für Ringe bis 100mm mit Ratschen- / Feststellfunktion  
Code: OE98000098



Solid construction and unmatched reliability. CHANNELLOCK® Retaining Ring pliers have the kind of accuracy and engineering that'll keep them in your toolbox for years to come.

**Convertible retaining ring plier kit**

for rings from approx. 4 - 25mm

for rings up to 50mm

for rings up to 100mm with ratchet / lock mechanism



# LKW-HEBELEISEN HEAVY DUTY PRY BAR

**Schlagfester, ergonomischer Griff**  
Ergonomic and hammer resistant

**Sonderstahl, gehärtet und vergütet**  
Special steel, hardened and tempered

**Nr. 276 310**  
**LKW-Hebeleisensatz, 4-tlg.**  
Heavy duty pry bar kit, 4 pcs.

**610mm x 90°**  
**Nr. 276 301**  
Code: OE62000062

**910mm x 45°**  
**Nr. 276 302**  
Code: OE68000068

**610mm x 60°**  
**Nr. 276 303**  
Code: OE68000068

**900mm**  
**Nr. 276 304**  
Code: OE68000068

**45° Sonderstahl-Klinge**  
45° special steel

**1130mm, 8-kant, gehärtet und vergütet**  
1130mm, octagonal, coated and hardened

**Massiver Schlagkopf**  
Massive punch head

**Ergonomischer "DUO-GRIFF"**  
Ergonomic "DUO-HANDLE"

**Nr. 276 342**  
**LKW-Hebeleisen "DUO-GRIFF"**  
Heavy duty pry bar "DUO HANDLE"

**Gesamtlänge: 1150mm**  
Length: 1150mm



**Nr. 276 340**  
Code: OE68000068

**Wandhalterung für Hebeleisen**  
(ohne Werkzeuge)  
Steel wall rack (without tools)



**Schlagfester, ergonomischer Kunststoffgriff**, ausgelegt zur Arbeit mit 2 Händen. Durchgehende 4-Kant Sonderstahlklinge 16x16mm mit massivem Schlagkopf für höchste Beanspruchung. Gehärtet und vergütet, nachschleifbar.

**Nr. 276 310 LKW-Hebeleisen-Satz, 4-tlg.**  
Code: OE198000198

**Nr. 276 342 LKW-Hebeleisen "DUO-GRIFF"**  
Code: OE138000138



**Ergonomic, hammer resistant handle** for 2-hand use. Special steel 16x16mm going through handle, massive punch head for toughest daily work. Made for heavy duty jobs as truck, offshore....

**Heavy duty pry bar kit, 4 pcs.**

**Heavy duty pry "DUO HANDLE"**

## GELENKKOPF-HEBELEISEN SWIVEL HEAD PRY BAR



**Universell einsetzbares Hebelwerkzeug.** Gelenk-Schwenkopf in zahlreiche Positionen verstellbar. Schmales Profil ermöglicht den Einsatz der Hebeleisen an engen und schwer zugänglichen Stellen. Perfekte Einstellmöglichkeiten je nach Anforderung. Integrierter Ratschenmechanismus.

**Nr. 276 321** **Schweres Teleskop-Hebeleisen**  
Code: OE168000168 **530-840mm**

**Nr. 276 323** **Schweres Teleskop-Hebeleisen**  
Code: OE198000198 **760-1270mm**

**Nr. 276 500** **Gelenkkopf-Hebeleisen-Satz, 3-tlg.**  
Code: OE112000112 **240, 320 + 390mm**

**Nr. 276 504** **Gelenkkopf-Hebeleisen XL,**  
Code: OE98000098 **620mm**

**Nr. 276 505** **Gelenkkopf-Hebeleisen XL,**  
Code: OE114000114 **880mm**

**Nr. 276 513** **Doppelgelenk-Hebeleisen**  
Code: OE68000068 **380mm**



**Universal pry bar.** Swivel head is adjustable in many positions. Useable for tight and difficult reachable spots. Perfect tool for users.

**Heavy duty extendable pry bar**  
**530-840mm**

**Heavy duty extendable pry bar**  
**760-1270mm**

**Swivel head pry bar kit, 3 pcs.**  
**240, 320 + 390mm**

**Swivel head pry bar XL,**  
**620mm**

**Swivel head pry bar XL,**  
**880mm**

**Double-joint pry bar**  
**380mm**

## KLEBEGEWICHT-ENTFERNER WHEEL WEIGHT REMOVER

**ergonomische Kante**  
ergonomic edge

**3-seitige Klinge**  
3-sides blade

**Klingenlänge: 160mm**  
Blade-length: 160mm



**Ergonomisch geformtes Werkzeug** zum Entfernen der Klebegewichte z. B. bei Alufelgen. Verschiedene Handhabungen möglich. Auch für zweckfremde Arbeiten z.B. an Innenverkleidungen, Zierleisten etc. Klinge auf einer Seite teilweise gerundet zur Anwendung mit zwei Händen. Siehe Abbildungen.

**Nr. 282 230 Klebegewicht-Entferner**  
Code: OE880000880



**Ergonomic tool** for removing sticky wheel weights. Different using possible, could be used also for trim removing. See pictures.

**Nr. 282 230 Wheel weight remover**  
Code: OE880000880



## KLEBEGEWICHTZANGE WHEEL WEIGHT PLIER

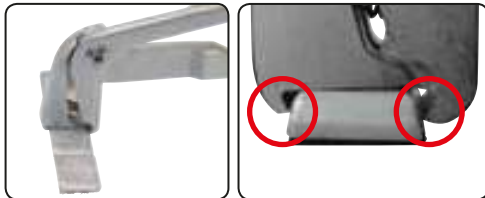

**Keine Beschädigung der Alufelge.**  
**Greift nur das Klebegewicht.**  
Does not touch rim. Grips weight only.



Zum beschädigungsfreien Entfernen der Auswucht-Klebegewichte an Alufelgen. Die Präzisionszange greift die Klebegewichte nur seitlich und verhindert so jegliche Beschädigung der Felge. Die Klebegewichte werden zur Seite "weggebrochen". Auch für hartnäckige, sehr festsetzende Gewichte.

Universell passend für nahezu alle Klebegewichte.

**Nr. 282 240 Klebegewichtzange**  
Code: OE68000068



- Specifically made to remove sticky wheel weights from aluminum rims.
- Thin edges grip the wheel weight without damaging the aluminum, leaving no scratches or notches in the metal.
- The pliers will never touch the wheel as the weights lean on their own tape.
- Features a spring-loaded handle.
- Rubber coated grip provides a comfortable handle.
- Wheel weights are fast and easy to remove.

**Wheel Weight Plier**

## MAGNETHALTER FIXPOINT MAGNET HOLDER FIXPOINT



Nr. 294 801

Magnet  
Ø 100mm

Magnetische Haftkraft ca. 90Kg  
Magnetic power app. 90Kg

Kunststoff-  
beschichtet  
Plastic coating

Nr. 294 810

## MAGNETSCHALEN-SATZ MAGNETIC PARTS BOWL



Nr. 905 007/orange



Nr. 905 007/neon Nr. 905 007/darkblue Nr. 905 007/gray

Nr. 905 007/darkblue

Code: OE248002480

**Magnetschalen-Satz, 2-teilig, darkblue**  
Magnetic Parts Bowl, 2 pcs., darkblue

Nr. 905 007/gray

Code: OE248002480

**Magnetschalen-Satz, 2-teilig, gray**  
Magnetic Parts Bowl, 2 pcs., gray

Nr. 905 007/neon

Code: OE248002480

**Magnetschalen-Satz, 2-teilig, neon**  
Magnetic Parts Bowl, 2 pcs., neon

Nr. 905 007/orange

Code: OE248002480

**Magnetschalen-Satz, 2-teilig, orange**  
Magnetic Parts Bowl, 2 pcs., orange



**Professionelle magnetische Haltevorrichtung** zur sicheren Ablage des Schlagschraubers. Kunststoffbeschichtung in Signalfarbe. Magnet Ø 100 mm, magnetische Haftkraft ca. 90 kg!



**No kind of fitting works** such as drilling or thread cutting necessary. Plastic coated in signal color. Magnet Ø 100 mm, magnetic power app. 90 kg!

**Nr. 294 801 Magnethalter Fixpoint**  
Code: OE415004150  
Magnet-holder

**Nr. 294 802 Magnethalter Fixpoint, 2 Stk.**  
Code: OE810000081  
Magnet-holder, 2 pcs.

**Nr. 294 810 Magnethalter Fixpoint XL**  
Code: OE490000049  
Magnet-holder XL

**Nr. 294 820 Magnethalter Fixpoint XL, 2 Stk.**  
Code: OE940000094  
Magnet-holder XL, 2 pcs.

## SICHERHEITS-MONTAGETRITT SAFETY MOUNTING STEP

**Rutschfestes und feuerverzinktes Gitterrost**  
Anti-slip and hot-dip galvanised gridiron

**Schräggestellte Standfüße verhindern ein Kippen**  
Can not slip thanks to cocked feet



**Kein Kippen durch schräggestellte Standfüße.** Rutschfestes, feuerverzinktes Gitterrost. DIN 50976. Massive, verwindungssteife Stahlrohrkonstruktion. Für den täglichen, professionellen Werkstatteinsatz.

**Nr. 510 051**  
Code: OE153000153

**Sicherheits-Montagetritt,  
2-stufig**

**Nr. 510 051/A2**  
Code: OE298000298

**Sicherheits-Montagetritt,  
2-stufig, 2 Stk.**



**Can not slip thanks to cocked feet.** Anti-slip, hot-dip galvanised gridiron. DIN 50976. Solid, non-distorting steel tube construction. For daily professional garage use.

**Safety mounting step**

**Safety mounting step, 2 pcs.**



**ROLLBRETT  
CREEPER**

**Maße Rollbrett:** 420 x 1.020 mm  
**Maße Auflage:** 300 x 1.000 mm  
**Arbeitshöhe:** 70 mm  
**Ø Rollen:** 50mm

Size Creeper: 420 x 1.020 mm  
Size Bed: 300 x 1.000 mm  
Height: 70 mm  
Ø Wheels: 50 mm



**Professionelles Rollbrett** zum täglichen Gebrauch in Werkstatt, Hof und Servicefahrzeug. Gepolsterte Auflagefläche mit leicht erhöhtem Kopfteil. Öl- & säurebeständige, drehbare, 2-fach kugelgelagerte Kunststoff - Doppelrollen. Stabiler, vollverchromter Stahlrohrrahmen. Alle Teile einzeln lieferbar.

**Nr. 510 099 Rollbrett**

Code: OE179917990

Nr. 510 099/4E Ersatzrollen, VPE 4 Stk.

Code: OE256002560



**Oil and acid resistant**, revolving, double ball beared, plastic double wheels. Rugged, chrome plated steel tube frame. All parts available as spare parts. Packed in single carton.

**Creeper**

Single wheels, 4 pcs.

**1/2" x 600mm KNARREN-KNEBEL  
1/2" x 600mm RATCHET BREAKER BAR**



Für festsitzende Schraubverbindungen. Schwenkkopf 210° für schwer zugängliche Stellen.

**Nr. 512 610 1/2" x 600mm  
Knarren-Knebel**

Code: OE65000065

Nr. 512 611 Ersatzschwenkkopf mit Knarrenfunktion 1/2"

Code: OE460000046



Busts loose stubborn bolts. Swivel head design allows multiple positions, including the ability to use it straight as a speed handle for hard to reach areas.

**1/2" x 600mm  
Ratchet breaker bar**

Ratchet angle head 1/2"

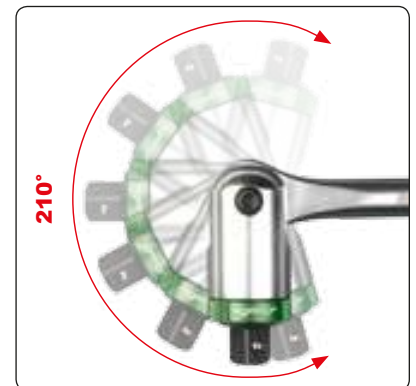

**KNEBEL 3/4"  
BREAKER BAR 3/4"**

**Universalwerkzeug für festsitzende Schraubverbindungen.**

**Nr. 512 630 Knebel 700mm x 3/4"**

Code: OE118000118

Nr. 512 631 Ersatzschwenkkopf 3/4"

Code: OE580000058



**Universal tool for tight screw connections.  
Breaker bar 700mm x 3/4"**

Swivel Head 3/4"

## VAKUUM-ABSAUGPUMPE VACUUM OIL EXTRACTOR



Mit Betätigung des Handhebels wird ein Vakuum innerhalb des Behälters erzeugt. Durch verschiedene Saug-Sonden können fast alle Flüssigkeiten am Fahrzeug abgesaugt werden. Liter-Einteilung am Behälter. Ideal z. B. für Motoröl, Getriebeöl, Kühlfüssigkeit, Bremsflüssigkeit, etc. Umfüllen der abgesaugten Flüssigkeit durch Herausnehmen der abgesteckten (nicht verschraubten) Absaugsonde. Fassungsvermögen: 6,5 Liter

**Nr. 515 006 Vakuum-Absaugpumpe  
6,5 Liter**  
Code: OE128000128



There will be generated a vacuum inside the tank when you use the pump handle. With different sucking probes all kind of liquids on the car can be sucked. Liter scale at the tank. Perfect for engine oil, transmission oil, brake oil coolant. Sucked liquid could be easily removed. Capacity: 6,5 liter.

**Vacuum oil and liquid  
Extractor 6,5 litre**



M5, M6, M7, M8, M10 + M12

M7, M8, M10, M12, M13 + M14



**Nr. 809 200  
Bitverlängerung 200mm  
Bit extension 200mm**



Passend für RIBE-Verschraubungen an Fahrzeugen wie z. B. FIAT, PEUGEOT, ALFA, LANCIA.

**Nr. 541 101 Keilzahn-Satz, 14-tlg.**  
Code: OE97000097

**Nr. 541 101/KV Keilzahn-Satz & Bitverlänge-  
rung 5/16"**  
Code: OE118000118

**Nr. 809 200**  
Code: OE38000038  
Bitverlängerung 5/16" x 200mm



Fits for RIBE connections on vehicles e.g. FIAT, PEUGEOT, ALFA, LANCIA.

**Keilzahn ribe set, 14 pcs.**

**Keilzahn ribe set & bit extension 5/16"**

Bit extension 5/16" x 200mm

## KEILZAHN-SATZ KEILZAHN-RIBE-SET

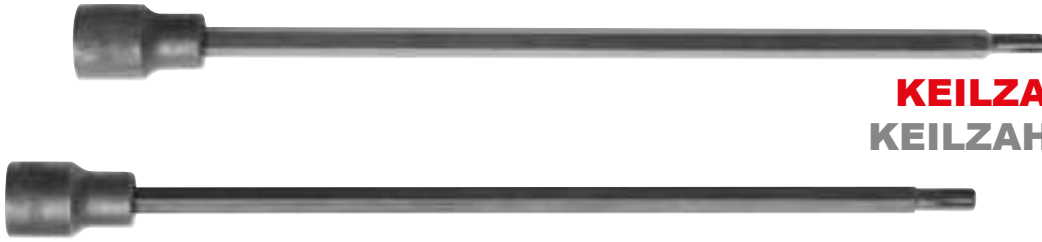

**KEILZAHN-STECKNUSS**  
**KEILZAHN-RIBE SOCKET**

**Länge: 250mm**  
Length: 250mm



**Passend für RIBE-Verschraubungen.**  
Speziell für italienische Fahrzeuge.



**Fits for RIBE connections,** especially for Italian cars.

- Nr. 541 306 M6 x 250mm x 1/2"  
Code: OE250000025
- Nr. 541 307 M7 x 250mm x 1/2"  
Code: OE250000025
- Nr. 541 308 M8 x 250mm x 1/2"  
Code: OE250000025

- Nr. 541 309 M9 x 250mm x 1/2"  
Code: OE250000025
- Nr. 541 310 M10 x 250mm x 1/2"  
Code: OE250000025
- Nr. 541 311 M11 x 250mm x 1/2"  
Code: OE250000025

- Nr. 541 312 M12 x 250mm x 1/2"  
Code: OE250000025
- Nr. 541 313 M13 x 250mm x 1/2"  
Code: OE250000025
- Nr. 541 314 M14 x 250mm x 1/2"  
Code: OE250000025



**TORX-SHOK-SATZ**  
**TORX-SHOK-SET**



**Universell passend für TORX-Verschraubungen.** Auch für Schlagschrauber geeignet. Extrem schlanke Ausführung.

**Nr. 544 020 Torx-Shok-Satz, 12-tlg.**  
Code: OE990000099



**Universal applicable for Torx-connections.** Can also be used with an impact wrench. Extra slim design.

**Nr. 544 020 Torx shok set, 12 pcs.**  
Code: OE990000099



**E6 x 28mm x 3/8"**  
Nr. 544 106  
Code: OE690000690



**E8 x 28mm x 3/8"**  
Nr. 544 108  
Code: OE740000740



**E10 x 38mm x 3/8"**  
Nr. 544 110  
Code: OE770000770



**E12 x 38mm x 3/8"**  
Nr. 544 112  
Code: OE148001480



**E14 x 38mm x 3/8"**  
Nr. 544 114  
Code: OE148001480



**E6 x 63mm x 3/8"**  
Nr. 544 206  
Code: OE126001260



**E8 x 63mm x 3/8"**  
Nr. 544 208  
Code: OE130000013



**E10 x 77mm x 3/8"**  
Nr. 544 210  
Code: OE150000015



**E12 x 77mm x 3/8"**  
Nr. 544 212  
Code: OE150000015



**E14 x 77mm x 3/8"**  
Nr. 544 214  
Code: OE150000015



**Winkelverlängerung**  
**1/2" x 52mm**  
Nr. 569 052  
Code: OE148001480



**Adapter innen 3/8"**  
**Adapter außen 1/2"**  
Nr. 808 106  
Code: OE168001680



## GELENKSCHLÜSSEL SATZ JOINT KEY KIT



Nr. 545 600



Für schwer zugängliche Stellen. Das lästige Umsetzen des Schlüssels entfällt durch den Schwenkkopf.

**Nr. 545 600 Gelenk 6-kant Stiftschlüssel Satz**  
Code: OE680000068



Nr. 545 700



Swivel head hex wrench for hard to reach areas.

**Joint hex key kit**

**Joint T-key kit**



180° Gelenk / 180° swivel

## WINKEL-STIFTSCHLÜSSEL SATZ 100° THE MUELLER COLOR CODED KIT



- Kurzer Schenkel ist kürzer als Standard, dadurch bessere Zugänglichkeit.
- Schneller Zugriff durch Farbcode.
- Bessere Ergonomie durch 100° Biegung.
- Made in Germany.

**Nr. 558 001 6-kant Winkel-Stiftschlüssel Satz 100°**  
Code: OE450000045

**Nr. 558 100 TORX Winkel-Stiftschlüssel Satz 100°**  
Code: OE480000048



- find your tools faster through individual colour codes
- 100° bending protects your knuckles.
- works better at narrow access areas, based on reduced shank-length
- Made in Germany

**Nr. 558 001 HEX color coded kit 100°**  
Code: OE450000045

**Nr. 558 100 TORX color coded kit 100°**  
Code: OE480000048



Nr. 558 001

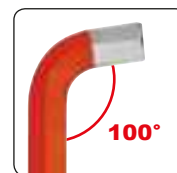

Nr. 558 100



**KLAUENSCHLÜSSEL-SATZ**  
**CROW FOOT WRENCH KIT**



Nr. 571 200



**Spezienschlüssel zum universellen Einsatz** in der PKW und LKW-Werkstatt. Besonders schlanke Ausführung für Arbeiten an schwer zugänglichen Stellen wie z. B. Einspritzleitungen, Klimaanlage, Servopumpe, Bremsleitung etc.

**Nr. 571 050 Klauenschlüsselsatz, 5-tlg.**  
Code: OE51000051  
**8, 9, 21, 22, 24mm**

**Nr. 571 100 Klauenschlüsselsatz, 10-tlg.**  
Code: OE51000051  
**10 - 19mm**

**Nr. 571 200 Klauenschlüsselsatz, 15-tlg.**  
Code: OE97000097  
**8 - 24mm**



**Special crow foot wrench kit.** Extra slim application for work on hard to reach areas e.g. delivery pipe, air conditioner, servo pump, brakeline etc.

**Crow foot wrench kit, 5 pcs.**  
**8, 9, 21, 22, 24mm**

**Crow foot wrench kit, 10 pcs.**  
**10 - 19mm**

**Crow foot wrench kit, 15 pcs.**  
**8 - 24mm**

**UNI-MONTAGEHAKEN SATZ**  
**MULTI FUNCTION MICRO TOOL KIT**



Ideal für O-Ringe, Dichtungen, Federringe etc.

**Nr. 604 230 Uni-Montagehaken Satz,**  
Code: OE32000032  
**3-tlg.**



Ideal for O-rings, spring rings, seals, connectors etc.

**Nr. 604 230 Multi function**  
Code: OE32000032  
**micro tool kit, 3 pcs.**

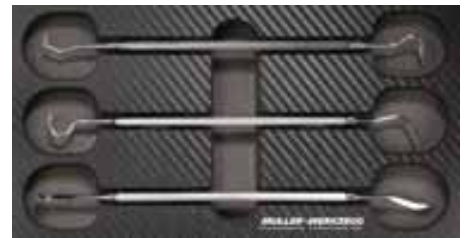
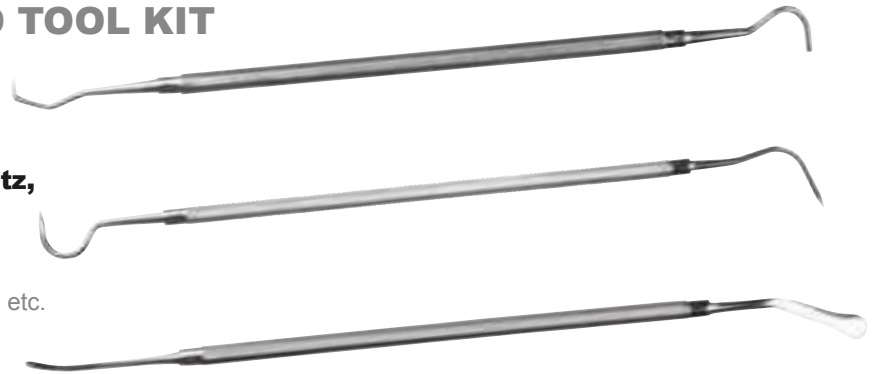

## UNI-ABZIEHSYSTEM 2+3 ARM, HYDRAULISCH HYDRAULIC TWIN / TRIPLE LEG PULLER SYSTEM



**Selbstgreifendes Prinzip**  
Self Gripping Principle





- Integrierte Hydraulikspindel 8 ton.
- Selbstspannende Konstruktion
- 2 + 3 Arm Abziehbrücke
- Lieferung in hochwertiger Schaumeinlage

**Nr. 650 700 Uni-Abziehsystem 2+3 Arm, hydraulisch**  
Code: OE498000498

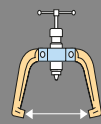
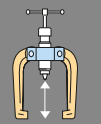

- 8 ton. ram, self gripping principle
- Combinaton twin / triple leg puller kit complete with ram extensions, offer a wide range of pulling options.
- Makes 2 different twin / triple leg pullers.
- Supplied in a foam inlay.

**Nr. 650 700 Hydraulic Twin / Triple Leg Puller System**  
Code: OE498000498

MÜLLER-WERKZEUG Technische Daten / technical information		
		
<b>x</b> Puller Spread	<b>x</b> Puller Reach Max	<b>x</b> Ram Extension
min - max mm	max mm	mm
50 - 100	100	50

## UNI-ABZIEHSYSTEM 2+3 ARM, HYDRAULISCH HYDRAULIC TWIN / TRIPLE LEG PULLER SYSTEM

**Ersatzteile** / Spare parts:

**Hydraulikspindel**

komplett

**Hydraulic Ram**

complete with nose piece

**Nr. 650 700-1**



**Abziehbrücke 2-Arm**

**Twin Head Assembly**

**Nr. 650 700-2**



**Abziehbrücke 3-Arm**

**Triple Head Assembly**

**Nr. 650 700-3**



**Kolbenverlängerung**

50mm

**Ram Extension**

50mm

**Nr. 650 700-6**



**Abzieharm 100mm**

Abzieh-Ø: 50 - 150 mm

**Standard Leg 100mm**

Puller-Ø: 50 - 150mm

**Nr. 650 700-7**

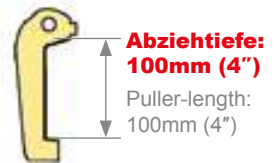

**Optional:**

**Abzieharm 150mm**

Abzieh-Ø: 50 - 150 mm

**Puller Leg 150mm**

Puller-Ø: 50 - 150mm

**Nr. 650 700-8**

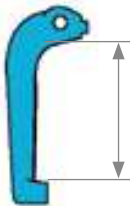

**Abziehtiefe: 150mm (6")**

Puller-length: 150mm (6")

**Abzieharm 200mm**

Abzieh-Ø: 100 - 200 mm

**Puller Leg 200mm**

Puller-Ø: 100 - 200mm

**Nr. 650 700-9**

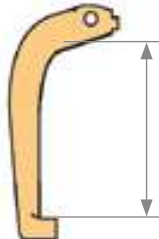

**Abziehtiefe: 200mm (8")**

Puller-length: 200mm (8")

**Abzieharm 250mm**

Abzieh-Ø: 130 - 250 mm

**Puller Leg 250mm**

Puller-Ø: 130 - 250mm

**Nr. 650 700-11**

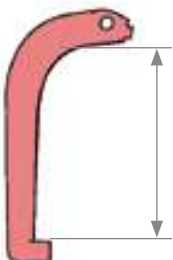

**Abziehtiefe: 250mm (10")**

Puller-length: 250mm (10")

**Kolbenverlängerung**

100mm

**Ram Extension**

100mm

**Nr. 650 700-5**



**Kolbenverlängerung**

150mm

**Ram Extension**

150mm

**Nr. 650 700-4**

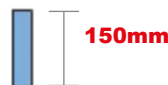

**Abziehtiefe**  
Puller-length

**Abzieh-Ø**  
Puller-Ø

## MAGNETHEBER BIEGBAR FLEXIBLE MAGNETIC PICK UP TOOL



Kleine, biegbare Bauweise für schwer zugängliche Stellen.  
Länge 400mm, max. 300 Gramm.

### Nr. 702 270 **Magnetheber biegbar**

Code: OE11000011



This flexible tool can reach into small / tight spaces to help you retrieve metal objects, which can weigh up to 300 grams.

Overall length is 400mm.

### **Flexible Magnetic Pick Up Tool**

## MAUL-RINGSCHLÜSSEL SATZ EXTRA KURZ COMBINATION WRENCH KIT



**Sehr kurzer und handlicher, leicht gekröpfter** 10-teiliger Maul-Ringschlüssel Satz. Zum Einsatz an schwer zugänglichen Stellen wie z. B. Bremsen, Motor, Türen, Armaturenbrett etc.

### Nr. 711 100 **Maul-Ringschlüssel Satz extra kurz**

Code: OE98000098



- ergonomisch perfekt
- nirgends scharfe Kanten
- neue ISO-Größen 16 + 18mm
- neuartiges, kombiniertes Maulprofil

- ergonomic design
- no sharp edges
- new sizes 16 + 18mm
- new open end design



**Extra short and handy 10 pcs. combination wrench kit 10 - 19 mm.** Use for hard to reach areas such as engine, doors, electric, dashboard, radio etc.

### **Combination Wrench Kit**

## DREHKOPFKNARRE 3/8" & 1/2" SWIVEL JOINT RATCHET 3/8" & 1/2"



**Für schwer zugängliche Verschraubungen.** Einsatz auch als Hub-Knarre. 3/8" Durchsteck 4-kant. Drehgelenk in jeder Position feststellbar.

**Nr. 731 031 Drehknopfknarre 3/8"**

Code: OE395003950

**Nr. 741 041 Drehknopfknarre 1/2"**

Code: OE580000058



**For screw connections that are not easily accessible.** Use as a reciprocating ratchet. 3/8" square socket. Pivot joint fixable in any position.

**Swivel joint ratchet 3/8"**

**Swivel joint ratchet 1/2"**

## FUNKTIONSPRÜFLAMPE MULTI-FUNCTION TEST LAMP



**Zur Funktionsprüfung von z. B. Bauteilen, Komponenten, Relais etc.** Austauschbare Spitze 6 - 48 Volt.

- Durchgangsprüfung
- Spannungsprüfung
- Integrierte LED Lampe
- Polaritätsfeststellung
- Fehlerdiagnose
- Thermosicherung etc.

**Nr. 727 006 Funktionsprüflampe, 6m Kabel**

Code: OE780000078

**Nr. 727 006/25 Funktionsprüflampe, 25m Kabel**

Code: OE112000112



**For functional testing e. g. assemblies, components, relays etc.** Replaceable probes 6 - 48 volts. 6m cable.

- Continuity test
- Voltage testing
- Integrated LED lamp
- Polarity determination
- Fault diagnosis
- Thermal fuse etc.

**Nr. 727 006 Multi-function Test Lamp, 6m cable**

Code: OE780000078

**Nr. 727 006/25 Multi-function Test Lamp, 25m cable**

Code: OE112000112



## PRÜF- & TESTLEITUNGS-SATZ TEST CABLE KIT

**Nr. 727 010-1**

**LED-Prüfkabel**  
LED-test-cable

**Nr. 727 010-2**

**Nadel-Prüfkabel**  
Needle-cable

**Nr. 727 010-4**

**Prüfspitze**  
Test-tip



**Nr. 727 010-8**

**Klemme**  
Clamp

**Nr. 727 010-10**

**Prüfkabel 1 m**  
Cable 1m

**Nr. 727 010-11**

**Injektions-Prüfspitze**  
Injection-tip



**Hochwertiger Prüf- + Testleitungs-Satz** z. B. zur Verwendung mit Nr. 727 006, Multimeter etc. Flexible Silikonkabel. Extra dünne Spitzen. Bi-Color LED Prüfkabel für Polaritätsanzeige.

**Nr. 727 010 Prüf- & Testleitungs-Satz, 14-tlg.**

Code: OE94000094



**High quality test cable kit.** Use in combination with no. 727 006, multimeter etc. Flexible silicone cables. Extra thin test tips. Bi-color LED's for polarity.

**Test cable kit, 14 pcs.**

## LEITUNGS-DEMONTAGESATZ LINE COUPLING DISCONNECT KIT

**Passend für Schnellverbinder an:  
Klimaanlagen, Kraftstoffleitungen, Luft + Ölleitungen**

Can be used for line coupling e.g.  
air conditioner, fuel line, air + oil line.



**Exakt passende Demontagewerkzeuge** für die sehr schwierig zu öffnenden Leitungskupplungen. Dieser Satz ist passend für nahezu alle Kupplungen an europäischen, asiatischen und amerikanischen Fahrzeugen.

**Nr. 727 030 Leitung-Demontagesatz**

Code: OE108000108



**Perfect tool to open  
the line coupling.**

Can be used for almost all European,  
Asian and American vehicles.

**Line coupling disconnect kit**

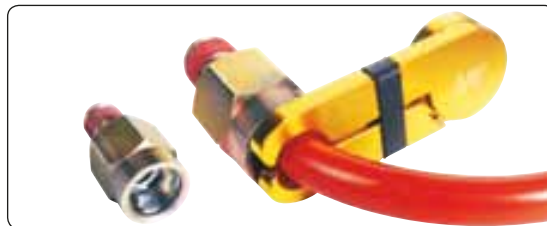

**KABELVERBINDER-ENTRIEGLUNGS-SATZ**  
**CABLE-DISCONNECT-KIT**



**Universal-Entrieglungs-Satz** für alle gängigen PKW-Steckkontakte z. B. Rundsteckkontakte, Flachsteckkontakte usw.

**Nr. 727 040 Kabelverbinder-Entrieglungs-Satz**  
Code: OE990000099



**Universal disconnecting kit** for the easy removal of cable-connections. Can be used for nearly all car-cable connections.

**Nr. 727 040 Cable-disconnect-kit**  
Code: OE990000099



**UNI VERLÄNGERER TYP 1 + 2**  
**UNI EXTENDER TYPE 1 + 2**

**Nr. 745 100/PW**

Länge / length: 340mm  
max. SW26 / 26mm



**Perfekt zum Lösen  
festsitzender Sechskant-, TX- oder  
XZN- Verschraubungen**

To loosen tight connection of hex, TX + XZN

**Ideale Passform**  
Fits perfect



**Nr. 745 102**

Länge / length: 580mm; max. SW46 / 46mm



**Universal Verlängerung** zum Lösen festsitzender Schraubenverbindungen an schwer zugänglichen Stellen. Passend für Maulschlüssel, Ring-Maulschlüssel, gekröpfte Ringschlüssel etc.

**Nr. 745 100/PW Uni Verlängerer Typ 1**  
Code: OE398003980

**Nr. 745 102 Uni Verlängerer Typ 2**  
Code: OE118000118



**Uni extender** to loosen tight connections on hard to reach areas.

**Uni extender type 1**

**Uni extender type 2**





## MONTAGEZANGEN SATZ LONG NOSE PLIER KIT



**Montagezange,  
S-Form Ausführung**  
Long nose plier s-type shape

**Nr. 748 100/S**  
Code: OE250000025

**Montagezange,  
gerade Ausführung**  
Long nose plier straight

**Nr. 748 100/G**  
Code: OE200000020



**Montagezange 45°  
überlange  
Ausführung**  
Long nose plier 45°

**Nr. 748 100/45°**  
Code: OE200000020

**Montagezange 90°  
überlange Ausführung**  
Long nose plier 90°

**Nr. 748 100/90°**  
Code: OE200000020



**Universell einsetzbare Montagezangen** in überlanger Ausführung. Handgriffe Kunststoff-überzogen. Ideal für Arbeiten an schwer zugänglichen Stellen.

**Nr. 748 104 Montagezangen Satz, 4-tlg.**

Code: OE760000076



**Universal plier extra long.** Handles rubber coated. Perfect for work at hard to reach areas.

**Long nose plier kit, 4 pcs.**

## VERLÄNGERUNGSSATZ "QUIKFIX" EXTENSION SET "QUIKFIX"



**Universal Verlängerungssatz 3/8"** und Knebel mit Verriegelung. Extra schlanke Verriegelungshülse (dünner als Stecknuss) für schwer zugängliche Stellen. Ergonomisch ausgeformte Form, hochglanz-polier. Antrieb: 3/8"

**Nr. 782 100 Verlängerungssatz "Quikfix"**  
Code: OE960000096



**Universal extension set 3/8"** and T-handle with lock, extra slim locking sleeve. For locations that are not easily accessible. Ergonomic shape, mirror finish. Drive: 3/8"

**Nr. 782 100 Extension set "Quikfix"**  
Code: OE960000096



**250mm x 3/8"**  
**Nr. 782 100-250**  
Code: OE260000026

**600mm x 3/8"**  
**Nr. 782 100-600**  
Code: OE420000042

**32mm x 3/8"**  
**Nr. 782 100-32**  
Code: OE120000012

**125mm x 3/8"**  
**Nr. 782 100-125**  
Code: OE180000018

**75mm x 3/8"**  
**Nr. 782 100-75**  
Code: OE148001480

**Knebel x 3/8"**  
**Nr. 782 100-101**  
Code: OE190000019

**KARDANGELN-STECKNUSS-SATZ**  
**12-POINT UNIVERSAL**  
**JOINT SOCKET SET**

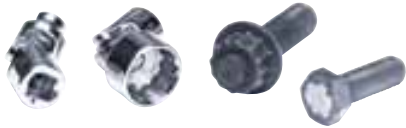

SW8 - 19mm 3/8"



**Gelenk-StecknuSSsatz 12-tlg.** Für schwer zugängliche Stellen. Anwendung sowohl für 6-kant als auch für 12-kant Vielzahnschrauben. Ergonomisch ausgereifte Form, hochglanzpoliert. Lieferung in stabiler Metallbox.

**Nr. 782 500 Kardangeln-StecknuSSsatz**

Code: OE118000118



**Universal 12-piece joint socket set.** For locations that are not easily accessible. Use for hexagonal and also for 12-point spline screws. Ergonomic shape, glossy finish. Delivery in a metal box.

**12-point universal joint socket set**

**UNI-ADAPTERSATZ**  
**UNI-ADAPTER KIT**



4 verschiedene Möglichkeiten in 2 Adaptern.  
 Verstellung durch Schiebe-Vierkant.

**Nr. 800 610 Uni-Adaptersatz, 2-tlg.**

Code: OE380000038



4 different sizes in 2 adaptors! Changeable adaptors.  
 From 1/4" - 3/8" + 3/8" to 1/4"; 3/8" - 1/2" + 1/2" - 3/8".  
 Saves time and space.

**Nr. 800 610 Uni-Adapter kit, 2 pcs.**

Code: OE380000038



**POLYGON-IMPACT GELENK SATZ**  
**POLYGON IMPACT JOINT KIT**



**Spezielle Kugel mit Flächen garantiert maximale Kraftübertragung. Rastmechanismus.** Dadurch als Gelenk und starr einsetzbar. 1/4", 3/8", 1/2"

**Nr. 810 203 Polygon-Impact Gelenk Satz 3-tlg.**

Code: OE680000068



**Special ball with flat areas ensures maximum torque transfer.** Works as joint and straight connector. 1/4", 3/8", 1/2"

**Nr. 810 203 Polygon Impact Joint Kit 3pcs.**

Code: OE680000068



## KRAFT-KUGELGELENK- STECKNUSS-SATZ

### IMPACT BALL JOINT SOCKET KIT

Nr. 810 689



**Speziell zur Verwendung an Radaufhängungen, Stoßdämpfern, Bremsen etc.** Kugelgelenk 30° abwinkelbar. Schlagschrauberfest.

**Nr. 810 303** Kraft-Kugelgelenk-Stecknuss-Satz,  
Code: OE98000098 **3-tlg. SW21, 22, 24 x 1/2"**

**Nr. 810 689** Kraft-Kugelgelenk-Stecknuss-Satz,  
Code: OE109000109 **4-tlg. SW16, 17, 18, 19 x 1/2"**



**Perfect for axle connections, shock absorbers, brakes etc.** Ball joint 30° swivel. Impact gun resistant.

**Impact ball joint socket kit, 3pcs.**  
**21, 22, 24mm x 1/2"**

**Impact ball joint socket kit, 4pcs.**  
**16, 17, 18, 19mm x 1/2"**



**Handlicher Umsteck-Schraubendreher** mit ergonomischem Griff und Umsteckfunktion. Top Qualität. In verschiedenen Ausführungen lieferbar.

**Nr. 905 003** Umsteck-Schraubendreher,  
Code: OE980000980 **mit Einsatz Kreuz PH 1 +2, Schlitz 3,0+5,5mm**

**Nr. 905 003/TX** Umsteck-Schraubendreher,  
Code: OE980000980 **mit Einsatz TX 10/15 - 20/25**

**Nr. 905 003/XZN** Umsteck-Schraubendreher,  
Code: OE980000980 **mit Einsatz XZN M4/M5 - M6/M8**

## UMSTECK-SCHRAUBENDREHER

### SCREWDRIVER TWIN END



**Handy screwdriver twin end** with ergonomic handle. Turnable bits. Top Quality.

**Screwdriver twin end, bit phillips PH 1 +2, slotted 3,0+5,5mm**

**Screwdriver twin end TX, bit TX 10/15 - 20/25**

**Screwdriver twin end XZN, bit XZN M4/M5 - M6/M8**

**ARBEITS-SCHUTZKISSEN**  
**WORK PROTECTION MAT**



**Professionelles Gesamterscheinungsbild der Werkstatt.** Keine Verwendung von Putzklappen, Kartons etc. Wasserabweisend. Wärmespeichernd durch spezielles 3-lagiges Softmaterial. Gesundheitsvorsorge. Benzin- und öl-fest, auch als Sitzauflage geeignet.

**Nr. 905 000/3 Knie-Schutzkissen Pack, 3 Stk.**  
Code: OE540000054

**Nr. 905 000/10 Knie-Schutzkissen Pack, 10 Stk.**  
Code: OE178000178

**Nr. 905 001 Arbeits-Schutzmatte**  
Code: OE580000058

**Nr. 905 001/2 Arbeits-Schutzmatte, 2 Stk.**  
Code: OE108000108



**Professional workshop equipment.** No use of old cartons etc. Water resistant. Health protection through 3-layer soft material. Oil and gasoline resistant. Can be used as well for seat protection

**Knee protection-pad, 3 pcs.**

**Knee protection-pad, 10 pcs.**

**Work protection mat**

**Work protection mat, 2 pcs.**



A x B x Cmm

480 x 36 x 320mm

480 x 36 x 320mm

1150 x 36 x 550mm

1150 x 36 x 550mm



**Auffangwanne** aus temperatur- und chemikalienbeständigem, bruchsicherem Kunststoff mit glatter und abriebfester Oberfläche. Für tiefergelegte Fahrzeuge geeignet. Inhalt: 28 Liter. Gewicht: 1,9 kg

**Nr. 902 390 Kühlwasser-Auffangwanne**

Code: OE360000036



**Heat and chemical resistant oil drain pan.** The plastic pan is break proof. With smooth and indelible surface. Content: 28 liter. Weight: 1.9 kg.

**Nr. 902 390 Oil Drain Pan**

Code: OE360000036

**KÜHLWASSER-AUFFANGWANNE**  
**OIL DRAIN PAN**



**INDUSTRIE-SCHEREN**  
**HEAVY DUTY SCISSORS**



Industrie-Universalscheren für nahezu alle Materialien wie Plastik, Gummi, Karton, Dichtungen, Draht etc.. Die Schneiden sind mikroverzahnt.

**Nr. 905 070 Industrie-Universalschere mit Kabelschneider**

Code: OE198001980

**Nr. 905 080 Industrie-Universalschere**

Code: OE198001980



Mueller heavy duty scissors are ideal for leather, cloth, plastic, rubber, cardboard, gasket material, rope, wire and other materials. Both types have blades with micro teeth.

**Nr. 905 070 Mueller heavy duty scissor with cable cutter**

Code: OE198001980

**Nr. 905 080 Mueller heavy duty scissor**

Code: OE198001980

**EPOXYD-STAHLKNETMASSE**  
**EPOXY PUTTY**

**2 in 1 EpoxySteel**



**Epoxyd 2-Komponenten Stahlknetmasse.** Einfach in der Anwendung. Kann nach wenigen Minuten bearbeitet werden. Original EpoxySteel Stahlknetmasse kann man Bohren, Feilen, Fräsen, Sägen, Lackieren etc. Dauerhaft hitzebeständig bis 260°.

**Nr. 906 002/1 Stahlknetmasse ca. 50g**

Code: OE995000995

**Nr. 906 002 Stahlknetmasse ca. 50g, 24 Stk.**

Code: OE238823880



**2-component epoxy putty.** Easy to use. Can be reshaped after some minutes of hardening. Original EpoxySteel can be drilled, filed, milled, painted etc. Permanent heat resistant 260°. Peak temperature 290°.

**Nr. 906 002/1 Epoxy putty 50g**

Code: OE995000995

**Nr. 906 002 Epoxy putty 50g, 24pcs.**

Code: OE238823880



## UNI-HAKENSATZ UNI-HOOK-KIT



**Nr. 905 024**  
**starr**  
inflexible



Hakensatz zur universellen Anwendung wie z. B. Aufhängen des Bremsstellers, Aufbewahrung von Schläuchen oder Kabeln.

**Nr. 905 022 Uni-Hakensatz,**  
Code: OE118001180 biegsam / universell anpassbar

**Nr. 905 024 Uni-Hakensatz, starr**  
Code: OE118001180



Hook-kit for universal applications such as brake caliper, cables, hoses etc.

**Nr. 905 022 Uni-Hook-Kit,**  
Code: OE118001180 bendable / universally adjustable

**Nr. 905 024 Uni-Hook-Kit, inflexible**  
Code: OE118001180

**Nr. 905 022**  
**biegsam / universell anpassbar**  
bendable / universally adjustable

**z. B. für Bremsstellers,  
Kabel etc.**  
i. e. brake caliper, cords etc.

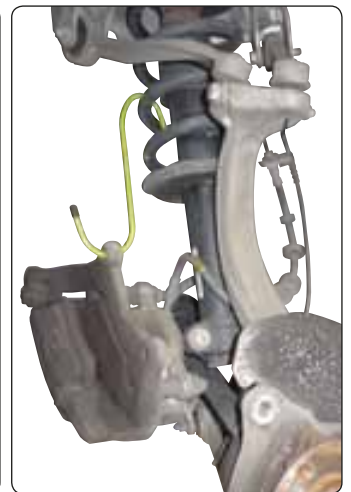

## LED-DUO WERKSTATTLAMPE / LADEVORGANG KABELLOS LED-DUO LAMP / WIRELESS CHARGER

MÜLLER-WERKZEUG Technische Daten / technical information			
	Work light		Flashlight
	<b>100%</b>	<b>40%</b>	<b>100%</b>
<b>Leuchtkraft / Light output</b>	500lm	250lm	135lm
<b>Leuchtdauer / Run time</b>	2,5h	5h	5h
<b>Leuchtabstand / Beam distance</b>	27m	19m	38m
<b>Spitzen Leuchtintensität / Peak Beam Intensity</b>	187cd	92cd	375cd
<b>Absorption / impact resistance</b>	2 Meter		
<b>Batterie / battery</b>	18.650 (3.7V / 2.600 mAh)		



Universal LED-Werkstattlampe mit Haken, Magnet und kabelloser Ladeschale. Leuchtdauer: 2,5 - 5Std.

**Nr. 904 996 LED-Duo Werkstattlampe/  
Code: OE398003980 Ladevorgang kabellos**



Universal LED-lamp with hook, magnet and wireless charger. Run time: 2.5 - 5h

**LED-DUO Lamp /  
Wireless Charger**

**600 LUMEN**

**Li 2.6 Ah**





# TRANSPORTER & LKW HEAVY DUTY & TRUCKS

**MÜLLER Tipp:**  
elektronisches Dokument  
Artikelsuche mit "Strg + F"

**MUELLER Tip:**  
electronic document  
Product Search "Ctrl + F"

**Apple:** "⌘ + F"



## LKW-HEBELEISEN HEAVY DUTY PRY BAR

**Schlagfester, ergonomischer Griff**  
Ergonomic and hammer resistant



**610mm x 90°**  
**Nr. 276 301**  
Code: OE62000062

**Sonderstahl, gehärtet und vergütet**  
Special steel, hardened and tempered



**910mm x 45°**  
**Nr. 276 302**  
Code: OE68000068



**610mm x 60°**  
**Nr. 276 303**  
Code: OE68000068

**Nr. 276 310**  
**LKW-Hebeleisensatz, 4-tlg.**  
Heavy duty pry bar kit, 4 pcs.



**900mm**  
**Nr. 276 304**  
Code: OE68000068



**Massiver Schlagkopf**  
Massive punch head

**Ergonomischer "DUO-GRIFF"**  
Ergonomic "DUO-HANDLE"

**45° Sonderstahl-Klinge**  
45° special steel

**1130mm, 8-kant, gehärtet und vergütet**  
1130mm, octagonal, coated and hardened

**Gesamtlänge: 1150mm** Length: 1150mm

**Nr. 276 342**  
**LKW-Hebeleisen "DUO-GRIFF"**  
Heavy duty pry bar "DUO HANDLE"



**Nr. 276 340**  
Code: OE68000068

**Wandhalterung für Hebeleisen**  
(ohne Werkzeuge)  
Steel wall rack (without tools)



**Schlagfester, ergonomischer Kunststoffgriff**, ausgelegt zur Arbeit mit 2 Händen. Durchgehende 4-Kant Sonderstahlklinge 16x16mm mit massivem Schlagkopf für höchste Beanspruchung. Gehärtet und vergütet, nachschleifbar.

**Nr. 276 310 LKW-Hebeleisen-Satz, 4-tlg.**  
Code: OE198000198

**Nr. 276 342 LKW-Hebeleisen "DUO-GRIFF"**  
Code: OE138000138



**Ergonomic, hammer resistant handle** for 2-hand use. Special steel 16x16mm going through handle, massive punch head for toughest daily work. Made for heavy duty jobs as truck, offshore....

**Heavy duty pry bar kit, 4 pcs.**

**Heavy duty pry "DUO HANDLE"**



## GELENKKOPF-HEBELEISEN SWIVEL HEAD PRY BAR



**Universell einsetzbares Hebelwerkzeug.** Gelenk-Schwenkkopf in zahlreiche Positionen verstellbar. Schmales Profil ermöglicht den Einsatz der Hebeleisen an engen und schwer zugänglichen Stellen. Perfekte Einstellmöglichkeiten je nach Anforderung. Integrierter Ratschenmechanismus.

**Nr. 276 321** **Schweres Teleskop-Hebeleisen 530-840mm**  
Code: OE168000168

**Nr. 276 323** **Schweres Teleskop-Hebeleisen 760-1270mm**  
Code: OE198000198

**Nr. 276 500** **Gelenkkopf-Hebeleisen-Satz, 3-tlg. 240, 320 + 390mm**  
Code: OE112000112

**Nr. 276 504** **Gelenkkopf-Hebeleisen XL, 620mm**  
Code: OE98000098

**Nr. 276 505** **Gelenkkopf-Hebeleisen XL, 880mm**  
Code: OE114000114

**Nr. 276 513** **Doppelgelenk-Hebeleisen 380mm**  
Code: OE68000068



**Universal pry bar.** Swivel head is adjustable in many positions. Useable for tight and difficult reachable spots. Perfect tool for users.

**Heavy duty extendable pry bar 530-840mm**

**Heavy duty extendable pry bar 760-1270mm**

**Swivel head pry bar kit, 3 pcs. 240, 320 + 390mm**

**Swivel head pry bar XL, 620mm**

**Swivel head pry bar XL, 880mm**

**Double-joint pry bar 380mm**

## UNIVERSAL REINIGUNGSSET FÜR KONTAKTFLÄCHEN AIR ANGLE GRINDER KIT



Nr. 111 812

MÜLLER-WERKZEUG Technische Daten / technical information		
Gewicht / weight	Kg	0,50
Länge / length	mm	120
Anschlussgewinde / air nipple	Zoll	1/4"
Schlauchanschluss / air hose	mm	9-13
Luftverbrauch / air consumption	l/min	250
Drehzahl/min / rpm	Rpm	15000
Arbeitsdruck / air pressure	bar	6,2
Geräuschpegel / sound level	dBA	85



**optional**  
**Mini Lamellenscheiben  
Ø 50mm, 10er Pack**  
Mini flap disc Ø 50mm, 10pack

**Nr. 111 550/K40 Körnung K40**  
Code: OE290000029 grid K40

**Nr. 111 550/K60 Körnung K60**  
Code: OE290000029 grid K60

**Nr. 111 550/K80 Körnung K80**  
Code: OE290000029 grid K80



Nr. 111 816  
Code: OE128000128

**2-stufig,  
8.000 / 15.000 U/min**  
2-steps,  
8.000 / 15.000 RPM

### Einzelteile / spare parts:

**grobe Körnung**  
rough grain



Nr. 111 050  
Code: OE2900000290

**extra grobe Körnung**  
extra rough grain



Nr. 111 050/PUR  
Code: OE3900000390

**feine Körnung**  
fine grain



Nr. 111 360  
Code: OE980000980

**mittlere Körnung**  
medium grain



Nr. 111 350  
Code: OE980000980

**grobe Körnung**  
rough grain



Nr. 111 350/PUR  
Code: OE980000980



**Ergonomischer Winkelschleifer, 2-stufig.** Optimale Handhabung durch 70° Winkelstellung. 2-stufig, 8.000 / 15.000U/min. Schnellwechselschleifteller Ø 50mm. Passend für Roloc-System zum Schleifen, Entgraten, Polieren und Finishen. Zum Beispiel für Radnaben etc. 16-tlg.

**Nr. 111 812 Universal Reinigungsset für Kontaktflächen, 16-tlg.**  
Code: OE198000198



**Ergonomic angle grinder.** 70° angle head for optimized use. 2-step, 8000 / 15.000RPM. Quick-change pad Ø 50mm. Fits for Roloc-system sanding pad. Max speed: 15.000RPM. 16 pcs. kit.

**Air Angle Grinder Kit, 16 pcs.**

## CLIP HEBER SET, 5-TEILIG CLIP LIFTER SET, 5-PIECES



Nr. 277 015

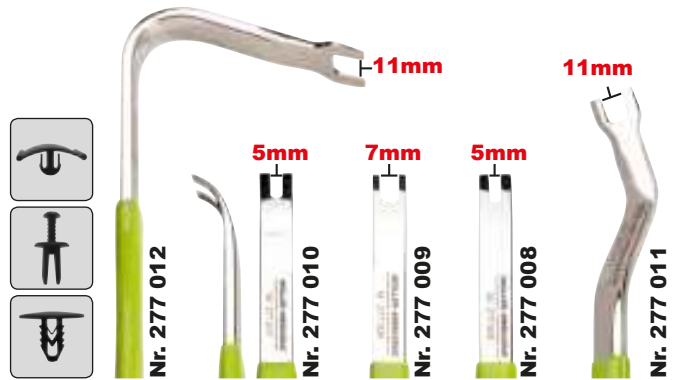

## XL-CLIP HEBER SET, 3-TEILIG XL-CLIP LIFTER SET, 3-PIECES



Nr. 277 023



Universalwerkzeug zum Lösen der Kunststoff-Nieten, Clips etc.

### Nr. 277 015 Clip Heber Set, 5-tlg.

Code: OE998009980

Nr. 277 008 Clip Heber 5mm

Code: OE1980001980

Nr. 277 009 Clip Heber 7mm

Code: OE1980001980

Nr. 277 010 Clip Heber 5mm, halbrund

Code: OE1980001980

Nr. 277 011 Clip Heber 11mm, S-Form

Code: OE1980001980

Nr. 277 012 Clip Heber 11mm, gewinkelt

Code: OE1980001980

### Nr. 277 023 XL-Clip Heber Set, 3-tlg.

Code: OE880000088

Nr. 277 020 XL-Clip Heber S-Form, 370mm

Code: OE340000034

Nr. 277 021 XL-Clip Heber

Code: OE280000028

Nr. 277 022 XL-Clip Heber S-Form, 245mm

Code: OE280000028



For plastic fasteners, plastic clips, upholstery or door panels.

### Clip Lifter Set 5pcs

Clip Lifter 5mm

Clip Lifter 7mm

Clip Lifter 5mm half-round

Clip Lifter 11mm S-Form

Clip Lifter 11mm angled

### XL-Clip Lifter Kit 3-pcs

XL-Clip Lifter S-Shape, 370mm

XL-Clip Lifter

XL-Clip Lifter S-Shape, 245mm

### Abmessungen Dimensions

Länge length	Breite width
175mm	5 / 15mm
175mm	7 / 14mm
175mm	5 / 14mm
195mm	11 / 22mm
175mm	11 / 21mm
370mm	11mm
250mm	5mm
245mm	11mm



## VIBRO-IMPACT® SYSTEM



**Nr. 290 206**

<b>MÜLLER-WERKZEUG</b> Technische Daten / technical information		
<b>Antrieb / drive</b>	mm	10,2
<b>Gewicht / weight</b>	Kg	2,49
<b>Länge / length</b>	mm	292
<b>Anschlussgewinde / air nipple</b>	zoll	1/4"
<b>Schlauchanschluss / air hose</b>	mm	9-13
<b>Luftverbrauch / air consumption</b>	l/min	114
<b>Schläge/min / impacts/min</b>	Bpm	2200
<b>Arbeitsdruck / air pressure</b>	bar	6,2
<b>Geräuschpegel / sound level</b>	dBA	100

## VIBRO-IMPACT®



**Nr. 290 210**  
Code: OE290000029



**Nr. 290 220**  
Code: OE290000029



**Nr. 290 230**  
Code: OE460000046



**Nr. 290 241**  
Code: OE390000039



**VIBRO-IMPACT®** System-Werkzeug zum Lösen festsitzender Verbindungen. Der punktgenaue Schlag des extrem kräftigen Pressluft-Hammers hilft bei der Demontage von z. B. Kegelsitzverbindungen, Radlagern, Buchsen, festgerosteten Schraubverbindungen und wirkt unterstützend z. B. von Abzieh- und Silentwerkzeugen.

**Nr. 290 206 VIBRO-IMPACT® SYSTEM**  
Code: OE338000338

**VIBRO-IMPACT®** System-tool to loose tight connections. The high performance air hammer helps to disassemble e.g. conical seat connections, wheel bearings, bushes, rusted screw connections...

**VIBRO-IMPACT® SYSTEM**

## VIBRO-IMPACT® MEIßEL VIBRO-IMPACT® CHISELS

### VIBRO-IMPACT®



**VIBRO-IMPACT® Meißel**, verdrehsicher. In drei verschiedenen Ausführungen erhältlich: Karosserie-Trenn-Meißel, Flachmeißel und Halbrundmeißel. Aufnahme: 10,2mm.

**Nr. 290 217 VIBRO-IMPACT® Blech-Trenn-Meißel**  
Code: OE41000041

**Nr. 290 218 VIBRO-IMPACT® Flach-Meißel**  
Code: OE41000041

**Nr. 290 219 VIBRO-IMPACT® Halbrund-Meißel**  
Code: OE41000041

**Kugelführung, Verdrehsicherung**

Ball-guide, non-turn

**Aufnahme: 10,2mm**

Shaft: 10,2mm



Nr. 290 217



Nr. 290 218



Nr. 290 219



**VIBRO-IMPACT® Chisel**, non turnable. Three different constructions: Sheet metal cutter, flat chisel and half round chisel. Shaft: 10,2mm

**VIBRO-IMPACT® sheet metal cutter**

**VIBRO-IMPACT® chisel separator**

**VIBRO-IMPACT® half round**

**Nr. 290 214 VIBRO-IMPACT® Austreiber 6,5mm**  
Code: OE43000043

**VIBRO-IMPACT® pin 6.5mm**

**Nr. 290 236** Austreiber 8mm geschmiedet mit Zentrierkopf  
Code: OE38000038  
Pin driver 8mm, drop forged, center head

**Nr. 290 237** Austreiber 10mm geschmiedet mit Zentrierkopf  
Code: OE38000038  
Pin driver 10mm, drop forged, center head

**Nr. 290 238** Austreiber 12mm geschmiedet mit Zentrierkopf  
Code: OE38000038  
Pin driver 12mm, drop forged, center head

**Nr. 290 239** Austreiber 12mm geschmiedet, Zylinderform  
Code: OE24000024  
Pin driver 12mm, drop forged, cylinder head

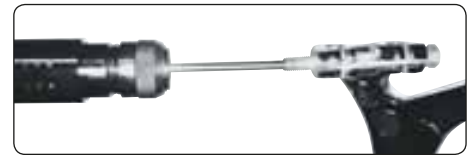

**Zum Trennen des inneren Auspuffrohres**

To cut the inner tube



**Zum Trennen des äußeren Auspuffrohres**

To cut the outside tube



**VIBRO-IMPACT® Auspuffmeißel-Satz, 2-tlg.**  
Zur Verwendung mit dem Druckluft-Hammer.

**Nr. 403 120 VIBRO-IMPACT® Auspuffmeißel**  
Code: OE84000084



**VIBRO-IMPACT® exhaust chisel set, 2pcs.**  
For use with the air hammer.

**VIBRO-IMPACT® exhaust chisel**

## KONKAV-AUSTREIBER CONCAVE HAMMER INSERT



Schrauben und Bolzen werden durch die konkave Form perfekt zentriert. Länge 150mm.

**Nr. 290 231 Konkav-Austreiber**  
Code: OE36000036



Bolts and pins will be perfect centered through concave shape. Length 150mm.

**Concave hammer insert**



## VIBRO-IMPACT® SPURSTANGEN-GABEL VIBRO-IMPACT® FORK CHISEL

**Geschmiedet aus einem Stück**  
drop forged

32 mm



**VIBRO-IMPACT®** Spurstangen-Gabel zum Lösen festsitzender Spurstangen und Kegelsitzverbindungen. Passend für MÜLLER Drucklufthammer, Nr. 290 200. Aus einem Stück geschmiedet. (keine Schraubverbindung am Werkzeug)

**Nr. 290 226 VIBRO-IMPACT® Spurstangengabel 20mm**  
Code: OE64000064

**Nr. 290 227 VIBRO-IMPACT® Spurstangengabel 25mm**  
Code: OE68000068

**Nr. 290 228 VIBRO-IMPACT® Spurstangengabel 32mm**  
Code: OE78000078



**VIBRO-IMPACT®** fork chisel to loose tight conical seat-connections. Fits for MUELLER Air Hammer, no. 290 200. Drop forged.

**VIBRO-IMPACT® Fork Chisel 20mm**

**VIBRO-IMPACT® Fork Chisel 25mm**

**VIBRO-IMPACT® Fork Chisel 32mm**

## VIBRO-IMPACT® NADELENTROSTER VIBRO-IMPACT® NEEDLE SCALER

### VIBRO-IMPACT®



Kombi-Aufsatz für MÜLLER Drucklufthammer zur Entrostung und Farbentfernung.

**Nr. 290 245 VIBRO-IMPACT® Nadelentrostler**  
Code: OE88000088



Additional unit to MUELLER Air Hammer for rust and paint removal.

**VIBRO-IMPACT® Needle Scaler**



## VIBRO-IMPACT® VERSCHRAUBUNGS-LÖSEWERKZEUG THREADED FASTENER / JOINT RELEASE TOOL



**Schnelles Lösen auch stark verrosteter Muttern** z. B. Spurstangen, Konterverschraubungen, Verschraubungen an Achskörpern usw. 190 mm lang. Bis max. SW22.

**Nr. 290 250 VIBRO-IMPACT®  
Verschraubungs-Lösewerkzeug**  
Code: OE168000168



**Quick release of heavily corroded nuts** e. g. on steering rods and bolted connections on axle bodies etc. 190 mm long. Max. 22mm.

**Nr. 290 250 VIBRO-IMPACT® Threaded  
Fastener / Joint Release Tool**  
Code: OE168000168

**hochwertige  
Ausführung**  
quality design

**ergonomischer  
Handgriff**  
ergonomic handle



# XL-VIBRO-IMPACT® DRUCKLUFTHAMMER

## HEAVY DUTY VIBRO-IMPACT® AIR HAMMER



Der punktgenaue Schlag des extrem kräftigen Pressluft-Hammers hilft bei der Demontage von z. B. Kegelsitzverbindungen, Radlagern, Buchsen, festgerosteten Schraubverbindungen und wirkt unterstützend z. B. von Abzieh- und Silentwerkzeugen.

### Nr. 290 300 XL-VIBRO-IMPACT® Drucklufthammer

Code: OE698000698



Heavy duty VIBRO-IMPACT® air hammer to loose tight connections at trucks, agricultural, construction etc. The high performance air hammer helps to disassemble e. g. conical seat connections, wheel bearings, bushes, rusted screw connections. Can support as well pullers.

### Nr. 290 300 Heavy Duty VIBRO-IMPACT® Air Hammer

Code: OE698000698

<b>MÜLLER-WERKZEUG</b> Technische Daten / technical information		
Antrieb / drive	mm	15mm 6-Kant / HEX
Gewicht / weight	Kg	5,40
Länge / length	mm	380
Anschlussgewinde / air nipple	Zoll	3/8"
Schlauchanschluss / air hose		13 mm / 1/2"
Luftverbrauch / air consumption	l/min	210
Schläge/min / impacts/min	BPM	2.500
Arbeitsdruck / air pressure	bar	6,2



Nr. 290 318



Nr. 290 338



Nr. 290 310



Nr. 290 320



Nr. 290 331

- Nr. 290 318 XL-VIBRO-IMPACT® Flachmeißel, 6-kant Schaft  
Code: OE680000068 Heavy Duty VIBRO-IMPACT® flat chisel
- Nr. 290 338 XL-VIBRO-IMPACT® Austreiber 20mm, 6-kant Schaft  
Code: OE680000068 Heavy Duty VIBRO-IMPACT® pin driver 20mm
- Nr. 290 310 XL-VIBRO-IMPACT® Spurstangen, 6-kant Schaft  
Code: OE124000124 Heavy Duty VIBRO-IMPACT® tie rod
- Nr. 290 320 XL-VIBRO-IMPACT® Hammer 6-kant Schaft  
Code: OE124000124 Heavy Duty VIBRO-IMPACT® hammer
- Nr. 290 331 XL-VIBRO-IMPACT® Konkav 6-kant Schaft  
Code: OE124000124 Heavy Duty VIBRO-IMPACT® concave

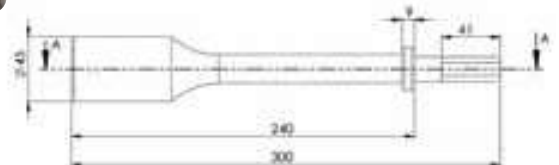

## LKW REIFENABDRÜCKER TYRE PUSHER



### Professioneller Druckluft-Reifenabdrücker.

Entwickelt für den mobilen Einsatz.

Betriebsdruck 6 - 8 bar.

Verwendung über Druckluft-Bordnetz möglich.

### Nr. EQ-290 480 LKW-Reifenabdrücker

Code: OE890000890



Professional tyre-pusher for the easy and mobile tyre-removing.

### Nr. EQ-290 480 Tyre Pusher

Code: OE890000890

MÜLLER-WERKZEUG Technische Daten / technical information		
Max. Presstiefe / stroke	mm	70,0
Gewicht / weight	Kg	4,8
Anschlussgewinde / air nipple	Zoll	1/4"
Schlauchanschluss / air hose	mm	9-13
Luftverbrauch / air consumption	l/min	350
Arbeitsdruck / air pressure	bar	6,2
Geräuschpegel / sound level	dBa	71



Für den mobilen Einsatz. LKW-Räder, Schlepper-Räder, Anhänger und Busse, Räder für Land- und Forstmaschinen.

### Nr. 290 485 LKW-Reifenabdrücker

Code: OE328000328



Loosens tire bead from the rim. Trucks, farm tractor etc.

### Nr. 290 485 Tyre Pusher

Code: OE328000328





# MÜLLER-SCHLAGSCHRAUBER IMPACT WRENCH

TOOL-INNOVATION  
2009

3-step power control



**3-stufiger Leistungsregler**  
3-step power-control

**Aluminium/Magnesium Schlagwerk-Gehäuse**  
housing

**Doppelhammer-Schlagwerk**  
Twin-Hammer



**ergonomischer Griff**  
ergonomic handle

**stufenloser Abzug**  
variable speed trigger

**echte Einhand-Bedienung**  
one handed operation

**DER MAßSTAB FÜR  
KRAFT!**

MÜLLER-WERKZEUG Technische Daten / technical information	1/4" MÜLLER 113		1/2" MÜLLER 114		1/2" MINI MÜLLER 115		3/8" MÜLLER 116	
	rechts	links	rechts	links	rechts	links	rechts	links
Max. Lösemoment / breakaway torque	Nm 90	90	1084	1600	500	680	500	680
Luftverbrauch / air consumption	l/min 105	105	135	135	105	105	105	105
Drehzahl / free speed	rpm 10.000	10.000	8.100	7.800	10.200	11.500	10.200	11.500
Antrieb / drive	inch 1/4"		1/2"		1/2"		3/8"	
Gewicht / weight	Kg 0.90		1.80		1.08		1.08	
Länge / length	mm 118		174		146		146	
Max. Arbeitsdruck / air pressure	bar 6,2		6,2		6,2		6,2	
Geräuschpegel / sound level	dBA 98.2		94.2		93.5		93.5	
Anschlussgewinde / air nipple	inch 1/4"		1/4"		1/4"		1/4"	
Schlauch / air hose	mm 9-13		9-13		9-13		9-13	
Vibration / vibration level	m/s 2.96		2.96		7.50		4.80	

**MÜLLER  
114**

**WE SET THE STANDARD  
FOR TORQUE!**



**Ultimative Power! Sehr starker Schlagschrauber mit neuartigem Design.** Ergonomisch perfekt angepasster Griff. Einhand-Umschalter kann auf Links- und Rechtshänder umgestellt werden. Geschwindigkeit + Rechts- und Links-Umstellung kann mit einer Hand bedient werden.

**Ausführungen /**  
models:

1/4"



1/2"



1/2" MINI  
+ 3/8"



**Nr. 294 114 1/2" Schlagschrauber, max. 1600 Nm**

Code: OE228000228

**Nr. 294 115 1/2" MINI-Schlagschrauber, max. 680 Nm**

Code: OE218000218

Nr. 294 113 1/4" Schlagschrauber, max. 90 Nm

Code: OE158000158

Nr. 294 116 3/8" MINI-Schlagschrauber, max. 680 Nm

Code: OE248000248



**Very strong Impact Wrench with new design.** Ergonomic handle. Variable speed trigger. One hand switch. 3-speed control. Forward & reverse control can be switched to left or right handed. Aluminium/ magnesium housing. High powerful twin-hammer.

**1/2" Impact Wrench, max. 1600Nm**

**1/2" MINI-Impact Wrench, max. 680Nm**

1/4" Impact Wrench, max. 90Nm

3/8" MINI-Impact Wrench, max. 680Nm



3-step power control

**3-stufiger Leistungsregler**  
3-step power-control

**Aluminium/Magnesium Schlagwerk-Gehäuse**  
housing

**Doppelhammer-Schlagwerk**  
Twin-Hammer

**stufenloser Abzug**  
variable speed trigger

**3/4" MÜLLER-SCHLAGSCHRAUBER**  
**3/4" IMPACT WRENCH**

WE SET THE STANDARD FOR **TORQUE!**

**MÜLLER 117**

**ergonomischer Griff**  
ergonomic handle



**echte Einhand-Bedienung**  
one handed operation

<b>MÜLLER-WERKZEUG</b> Technische Daten / technical information		<b>3/4" MÜLLER 117</b>	
		rechts	links
<b>Max. Lösemoment / breakaway torque</b>	Nm	2000	2600
<b>Luftverbrauch / air consumption</b>	l/min	200	210
<b>Drehzahl / free speed</b>	rpm	5.300	6.400
<b>Antrieb / drive</b>	inch	3/4"	
<b>Gewicht / weight</b>	Kg	3.20	
<b>Länge / length</b>	mm	215	
<b>Max. Arbeitsdruck / air pressure</b>	bar	6,2	
<b>Geräuschpegel / sound level</b>	dBA	105.1	
<b>Anschlussgewinde / air nipple</b>	inch	3/8"	
<b>Schlauch / air hose</b>	mm	9-13	
<b>Vibration / vibration level</b>	m/s	6.50	



**Nr. 801 800**  
Code: OE188000188

**3/4" Impact Stecknuss Satz**  
3/4" Impact Socket Kit

**DER MAßSTAB FÜR KRAFT!**



**Ultimative Power! Sehr starker Schlagschrauber mit neuartigem Design.** Ergonomisch perfekt angepasster Griff. Einhand-Umschalter kann auf Links- und Rechtshänder umgestellt werden. Geschwindigkeit + Rechts- und Links-Umstellung kann mit einer Hand bedient werden.

**Nr. 294 117 3/4" Schlagschrauber, max. 2600 Nm**

Code: OE668000668



**Very strong Impact Wrench with new design.** Ergonomic handle. Variable speed trigger. One hand switch. 3-speed control. Forward & reverse control can be switched to left or right handed. Aluminium/ magnesium housing. High powerful twin-hammer.

**3/4" Impact Wrench, max. 2600Nm**

**SCHUTZHÜLLE FÜR MÜLLER-SCHLAGSCHRAUBER**  
**PROTECTIVE COVER FOR MUELLER IMPACT WRENCH**

Hochbelastbar, abriebfest, schützt das Gerät zuverlässig.  
Heavy-duty, abrasion resistant, reliably protects the tool.

**Nr. 294 117/SH Schutzhülle für MÜLLER 117 3/4"**

Code: OE280000028

**Protective cover for MUELLER 117 3/4"**



**DER MAßSTAB FÜR  
KRAFT!**

**1" MÜLLER-SCHLAGSCHRAUBER  
1" MUELLER IMPACT GUN**



**Lange Spindel: 190mm**  
Long anvil: 190mm

**Nr. 294 119/V2**

**WE SET THE STANDARD  
FOR TORQUE!**

<b>MÜLLER-WERKZEUG</b> Technische Daten / technical information		
Antrieb / square drive	Zoll	1"
Max. Drehmoment / max. torque	Nm	3100
Anschlussgewinde / Air inlet	Zoll	1/2"
Gewicht / weight	Kg	6,8
Schlauchanschluss / air hose	mm	9-13
Luftverbrauch / air consumption	l/min	305
Drehzahl/min / free speed	Rpm	48
Arbeitsdruck / air pressure	bar	6,3
Geräuschpegel / sound level	dBA	110



**1" Schlagschrauber mit neuartigem Design.** Doppelschlagwerk. Magnesium Schlagwerk-Gehäuse. Extrem schneller Drehmomentaufbau. 4-stufige Einstellmöglichkeit der Schlagleistung. Sehr leichte Bauweise. Gesamtgewicht 6.8Kg. Kurze Antriebsspindel: 38mm oder lange Antriebsspindel: 190mm.

Max. Losbrechmoment: 3100Nm.

Das Gerät kann von Rechts- und Linkshändern bedient werden.

**Nr. 294 118/V2 1" Druckluft-Schlagschrauber, kurze Spindel**  
Code: OE998000998

**Nr. 294 119/V2 1" Druckluft-Schlagschrauber, lange Spindel**  
Code: OE998000998



**Nr. 294 118/V2**



**1" Impact wrench with perfect handling.** Powerful twin-hammer mechanism. Magnesium housing. Lightest 1" impact-gun. Only 6.8Kg weight. Short anvil: 38mm. Long anvil: 190mm. Max. torque: 3100Nm

**1" MUELLER Impact Gun, short anvil**

**1" MUELLER Impact Gun, long anvil**

**INDUSTRIE-DRUCKLUFTKNARRE**  
**AIR RATCHET**

**DER MAßSTAB FÜR**  
**KRAFT!**

**WE SET THE STANDARD**  
**FOR TORQUE!**

**ULTIMATIVE POWER**  
**1/2" 170Nm**

<b>MÜLLER-WERKZEUG</b>		<b>MÜLLER 214</b>	<b>MÜLLER 215</b>	<b>MÜLLER 216</b>	<b>MÜLLER 217</b>
<b>Technische Daten / technical information</b>					
<b>Antrieb / square drive</b>	inch	1/2"	3/8"	1/4"	3/8"
<b>Max. Drehmoment / max. torque</b>	Nm	170	170	60	60
<b>Drehzahl / free speed</b>	Rpm	180	180	270	270
<b>Luftverbrauch / air consumption</b>	l/min	113	113	100	100
<b>Gewicht / weight</b>	Kg	1.55	1.55	0.70	0.70
<b>Länge / length</b>	mm	320	320	225	225
<b>Max. Arbeitsdruck / air pressure</b>	bar	6,2	6,2	6,2	6,2
<b>Geräuschpegel / sound level</b>	dBA	84.2	84.2	92.1	92.1
<b>Anschlussgewinde / air inlet</b>	inch	1/4"	1/4"	1/4"	1/4"
<b>Schlauch / air hose</b>	mm	9-13	9-13	9-13	9-13
<b>Vibration / vibration level</b>	m/s	10.2	10.2	14.1	14.1



**Hochleistungs-Druckluftknarre mit neuartigem Design.** Ergonomisch perfekt angepasster Griff. Ultimative Leistung! Stufenloser Abzug. 360° drehbarer Abluftring.

**Nr. EQ-294 214 MÜLLER 214 1/2" Druckluftknarre**  
Code: OE218000218

**Nr. EQ-294 215 MÜLLER 215 3/8" Druckluftknarre**  
Code: OE218000218

**Nr. EQ-294 216 MÜLLER 216 1/4" Druckluftknarre**  
Code: OE168000168

**Nr. EQ-294 217 MÜLLER 217 3/8" Druckluftknarre**  
Code: OE168000168



**Air ratchet with perfect handling.** Ergonomic handle. 360° turnable exhaust. Ultimate torque!

**MUELLER 214 1/2" Air Ratchet**

**MUELLER 215 3/8" Air Ratchet**

**MUELLER 216 1/4" Air Ratchet**

**MUELLER 217 3/8" Air Ratchet**

## SIGNAL-DRUCKLUFTSCHLAUCH SIGNAL AIR HOSE

3/8" - 10mm

**SIGNAL**

**MÜLLER-WERKZEUG**

**SIGNAL**

**MÜLLER-WERKZEUG**

# SIGNAL

- Gut sichtbare **SIGNAL** Farbe
- Temperaturbeständig von **-40°C bis +65°C**
- **Abriebfest**
- **Hoch-flexibel**
- **Schützt vor Unfällen**
- **Arbeitsdruck: max. 20 bar**
- **Berstdruck: 68 bar**

- High-Visible **SIGNAL** color
- Temp. range: from **-40°C till +65°C**
- Abrasion-resistant outside cover
- Ultra flexibility
- Improves workplace safety
- Working pressure: 300 PSI
- Break pressure: 1000 PSI

Nr. 297 214



Nr. 297 210

**Innen Ø 10mm**  
**Länge: 10m**

Inner Ø10mm (3/8")  
Length: 10m (32,8 ft)



3/8" - 10mm

**SIGNAL**

**MÜLLER-WERKZEUG**

**SIGNAL**

**MÜLLER-WERKZEUG**



**Hoch-flexibler Druckluftschlauch in gut sichtbarer SIGNAL Farbe.** Temperaturbeständig von **-40°C bis +65°C**. Extrem Abriebfest. Die leuchtende **SIGNAL** Farbe fällt optisch sofort auf und verhindert Stolperunfälle. Arbeitsdruck max. 20 bar. Berstdruck: 68 bar. Länge 10m / 50m

**Nr. 297 210** **SIGNAL-Druckluftschlauch**  
Code: OE390000039  
**10m x 10mm ohne Kupplung**

**Nr. 297 214** **SIGNAL-Druckluftschlauch**  
Code: OE740000074  
**10m x 10mm mit Kupplung**  
**DE & Rückschlagdämpfung**

**Nr. 297 215** **SIGNAL-Druckluftschlauch**  
Code: OE168000168  
**50m x 10mm ohne Kupplung**

**Nr. 297 315** **SIGNAL-Druckluftschlauch**  
Code: OE248000248  
**50m x 13mm ohne Kupplung**



**High-visible & ultra flexible SIGNAL air hose.** The **SIGNAL** color helps to improve workplace safety. Working pressure: 300PSI. Break pressure: 1000PSI. Length: 10meter (32,8 ft) / 50meter (164,0 ft)

**SIGNAL Air hose 3/8", 10m**

**SIGNAL Air hose 3/8", 10m**  
with coupling DE & safety nipple

**SIGNAL Air hose 3/8", 50m**

**SIGNAL Air hose 1/2", 50m**

## DL-ADAPTER FÜR LKW BREMSANLAGE AIR ADAPTER FOR HEAVY DUTY BRAKE SYSTEM



**2-teiliger Satz zum Füllen der LKW-Druckluft Bremsanlage.** Anwendung am Reifenfüllanschluss des Druckreglers. Passend für alle gängigen Bremsanlagen, z. B. Bosch, Wabco, Grau...

**Nr. 400 402 DL-Adapter-Satz, 2-tlg.**

Code: OE380000038



**2 pcs kit to fill the air brake system of trucks.** Will be connected with the air regulator of the brake. Fits for all brake systems of Bosch, Wabco, Grau...

**Air adapter kit, 2 pcs.**

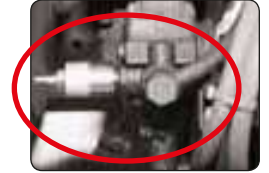

## LAGERRINGAUSTREIBER LKW BEARING REMOVER HEAVY DUTY



**Zum Ausschlagen von festsitzenden Lagerschalen.** Speziell geeignet für die äußeren Ringe der zweigeteilten Kegelrollenlager in den Radnaben.

**Nr. 432 500 Lagerringaustreiber LKW, 500mm**

Code: OE580000058



**For removing tight fitting bearing rings.** Especially good for removing the two piece cone bearings inside the wheel hubs.

**Bearing remover heavy duty, 500mm**



**Gesamtlänge: 500mm**  
Length: 500mm



## BREMSEFEDERHAKEN LKW SPRING BRAKE TOOL HEAVY DUTY



**Geschmiedet. Für Bremsbacken-Rückzugfedern** ohne Demontage/Montage der Anker- bzw. Staubplatte. In zwei Ausführungen erhältlich, 450mm für Iveco, 620mm LKW.

**Nr. 454 005 Bremsfederhaken LKW, 620mm**

Code: OE680000068

**Nr. 454 005/K Bremsfederhaken IVECO, 450mm**

Code: OE670000067



**Forged tool for brake release spring** without demounting the plate. Available in 2 lengths.

**Brake spring heavy duty, 620mm**

**Brake spring IVECO, 450mm**

450mm

620mm



## REIBAHLE FÜR ABS-SENSOR REAMER FOR ABS-SENSOR



**Zur Reinigung der Führungsbohrung** des ABS-Sensors im Radlagergehäuse von Rost, Schmutz, Korrosion etc.. Bei Anwendung des Werkzeuges keine Beschädigung des Neuteiles durch unsachgemäßes Einschlagen, Einpressen etc. Gewährleistung exakter Messwerte durch sauberen und korrekten Sitz des neuen Sensors. Durch integrierte, abgewinkelte, feinstverzahnte Spezialknarre nur Rechtsdrehung möglich. DBGM

**Nr. 456 184 ABS-Reibahle Ø18x45mm LKW**

Code: OE118000118



**To clean rust and oxidation** of the ABS-Sensor hole at the wheelbearing housing. This tool avoids that ABS-Sensors will break at installing process. Ensures exact measuring results, based on perfect fitting sensor seat. Integrated ratchet wrench. Pat.

**ABS-reamer Ø18x45mm**



# UNI-PRESS-UNTERLAGE UNI-PRESS-SUPPORT



**Höhenverstellbare Auflagebolzen**  
Adjustable anvil bolts

**Schwenkelement gewährleistet einfache Handhabung**  
Swivel element guarantees easy use



Nr. 432 650 + 609 390



**3-Punkt Auflage, wackel- und spielfrei**  
3-point contact, non swivelling

**Sicherheitsführung für Presstisch**  
Safety alignment for workshop-press



WATCH DEMO HERE:



**Universal-Auflageplatte** zur Verwendung an Werkstattpressen. Für Demontage- und Montagearbeiten. Durch Universal 3-Punkt Auflage wird eine wackel- und spielfreie Auflage gewährleistet.

**Nr. 432 650 Uni-Press-Unterlage**  
Code: OE298000298



**Universal-support** for use at workshop press. For demounting and mounting jobs. 3-point contact guarantees a perfect, non swivelling and save support.

**Uni-press-support**

## RADNABENABZIEHER PKW, SUV + TRANSPORTER WHEEL HUB PULLER SUV, HEAVY DUTY

**Nr. 609 210**

**Optional: 12 to. Hydraulik Spindel**

Option: 12 to. Hydraulic spindle



M14

M14x1,5

M12x1,5

**VIBRO-IMPACT® - Spindel  
TR20 zum Durchdrücken  
der Antriebswelle**

VIBRO-IMPACT® - spindle  
TR20 for pulling-out of the axle  
drive shaft

**Adapter für Stehbolzen: M14 + M16x1,5**  
Adapter for studs M14 + M16x1,5

**Adapter für Gleithammer: M20x1,5 A:UN1 1/2"**  
Adapter for slide hammer: M20x1,5 A:UN1 1/2"

**Ford Transit, MB Sprinter, RENAULT Master, VW LT, OPEL  
Movano, IVECO Daily, FIAT Ducato, PEUGEOT Boxer etc..**



**Nr. 433 450**

**Optional: Uni. Gleithammer extra schwer**

Option: Uni. Slide hammer extra heavy



**Zur Demontage z. B. Bremstrommeln, Bremsscheiben, Radnaben, Radlager, Lagereinheiten, Gelenkwellen.** Universell verwendbar mit Schlaggewicht oder Hydraulikspindel. Passend für:

**Radstehbolzen:**

5 + 6er Teilung M14 + M16x1,5 durch Aufschraubhülsen.

**Radschrauben:**

5 + 6er Teilung M12x1,5, M14 + M14x1,5

**Nr. 433 444 Radnabenabzieher Transporter**

Code: OE648000648



**For de-mounting brake-drums, brake-discs, wheel-hubs, wheel bearings, bearing-hub-units, drive-shafts.** Universal use with slide hammer or hydraulic spindle. Fits for **Wheel studs:**

5 + 6 holes wheels M14 + M16x1,5.

**Wheel bolts:**

5 + 6 holes wheels M12x1,5, M14 + M14x1,5

**Wheel hub puller heavy duty**



# SYSTEMANWENDUNGEN UNIVERSAL GLEITHAMMER

## SYSTEM APPLICATIONS UNIVERSAL SLIDE HAMMER



**537 710**  
**Antriebswellen-Trenner M16x1,5**  
Drive shaft separator M16x1.5



**433 433 + 433 450/14**  
**MÜLLER Universal Flansch + Adapter zur Radnabenmontage**  
MUELLER Universal flange and adapter for wheel hub mounting



**gesenkgeschmiedet**  
drop forged

**433 450/27**  
**Ford Mondeo Demontage Querlenker (auch DB Vito)**  
De-mounting Ford Mondeo lower suspension arm (also DB Vito)



**433 450/25**  
**Adapter für Doppelhaken**  
Adapter for double hook



**433 450/28**  
**Universal Doppelhaken für Karosserie**  
Universal double hook for bodywork

**433 450/4**  
**VW T4 Radnabe hinten mit vorhandenem Flansch + Adapter**  
VW T4 wheel hub with existing flange and adapter



**433 450/V2**  
**Universal Gleithammer**  
Universal Slide Hammer



**600 122**  
**Injektorenschieber DB CDI Motoren**  
Injector puller DB CDI motors

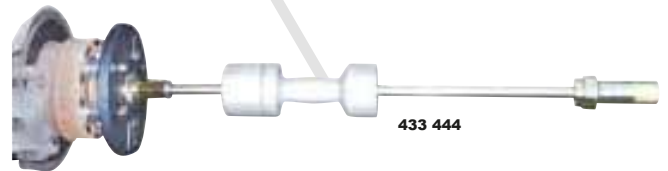

**433 444**

**Adapter mit Innengewinde M20x1,5 für MÜLLER Gleithammer**  
Adapter with inner thread M20x1.5 for MUELLER slide hammer

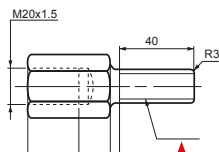

- Nr. 433 450/4** Code: OE380000038  
Außengewinde / outside thread M16x2,0
- Nr. 433 450/6** Code: OE380000038  
Außengewinde / outside thread M18x2,5
- Nr. 433 450/8** Code: OE380000038  
Außengewinde / outside thread M18x1,5
- Nr. 433 450/10** Code: OE380000038  
Außengewinde / outside thread M20x2,5
- Nr. 433 450/11** Code: OE380000038  
Außengewinde / outside thread M20x2,0
- Nr. 433 450/14** Code: OE380000038  
Außengewinde / outside thread UN1 1/2"
- Nr. 433 450/16** Code: OE380000038  
Außengewinde / outside thread M42x2 z. B. KL

**Adapter für bereits vorhandene Schlaggewichte mit anderen Gewinden**  
Adapter for existing slide hammers with other threads

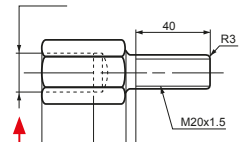

- Nr. 433 450/25** Code: OE380000038  
Adapter z. B. für Doppelhaken / Adapter e. g. for double hook
- Nr. 433 450/27** Code: OE380000098  
Ausziehbügel M20x1,5  
Kugelgelenke / Karosserie  
Massive, gesenkgeschmiedete Ausführung, auch z.B. für Karosseriearbeiten geeignet.  
Universal hook M20x1.5 for balljoints, bodywork  
Durable, drop-forged tool. Can be used as well for car-body works.
- Nr. 433 450/28** Code: OE380000088  
Doppelhaken / double hook
- Nr. 433 450/45** Code: OE380000038  
Innengewinde / inner thread UNC 5/8"
- Nr. 433 450/46** Code: OE380000038  
Innengewinde / inner thread M16x2,0
- Nr. 433 450/48** Code: OE380000038  
Innengewinde / inner thread M18x2,5
- Nr. 433 450/49** Code: OE380000038  
Innengewinde / inner thread M18x1,5
- Nr. 433 450/50** Code: OE380000038  
Innengewinde / inner thread M20x2,5
- Nr. 433 450/51** Code: OE380000038  
Innengewinde / inner thread M20x2,0

## RADNABENSCHLEIFER TYP 3 WHEEL HUB GRINDER TYPE 3

 **PATENTIERT**

**Lieferumfang Nr. 433 700:**  
**1 Grundgerät + 2 Scheiben**

Shipment no. 433 700: 1 basic unit + 2 discs



**Spezialschleifer zur Reinigung der Radzentrierung** und der Anlagefläche RAD zur NABE. Festgebrannte Korrosionsrückstände werden schnell, unkompliziert und restlos entfernt. Effektive Bearbeitungszeit je Nabe 3 - 25 Sekunden.

**Nr. 433 700 Radnabenschleifer Typ 3**

Code: OE960000096

Nr. 433 720

Code: OE640000064

Ersatzscheiben, VPE 2 Stk.



**Special grinder for cleaning the wheel centring device** and the attachment face between WHEEL and HUB. Stubborn corrosion residues are removed quickly, easily and completely. Actual processing time per hub 3 - 25 seconds.

**Wheel hub grinder type 3**

Spare discs, 2 pcs.

## 8-KANT LKW-RADNABENSCHLEIFER TYP 4 8-POINT WHEEL HUB GRINDER TYPE 4

**TOOL-INNOVATION**  
2013



 **PATENTIERT**

**Lieferumfang: 1 Grundgerät mit**  
**Scheibe + je 5 Scheiben**

Shipment: 1 basic unit incl. 5 discs each



**Spezialschleifer zur Reinigung der Felgenanlagefläche** für LKW und Transporter mit Stehbolzen. Rost an der Radnabe wird schnell und unkompliziert entfernt.

**Nr. 433 918 8-kant LKW-Radnabenschleifer**  
**Typ 4**

Code: OE112000112

Nr. 433 958

Code: OE290000029

8-kant Ersatzscheiben Typ 4, VPE 5 Stk.

Nr. 433 958/PUR 8-kant Ersatzscheiben grob, VPE 5 Stk.

Code: OE390000039



**Special grinder for the cleaning of the wheels rim contact surface.** For trucks and vans with studs. Corrosion are removed quickly and easily.

**8-point wheel hub grinder type 4**

8-point spare discs, 5 pcs.

8-point spare discs rough, 5 pcs.

## UNIVERSAL-BANDSCHLÜSSEL UNIVERSAL BELT WRENCH



Für Lufttrockner und Ölfilterkartuschen bis Durchmesser 180mm. Universell passend z.B. an Caterpillar Baumaschinen. Antrieb 1/2"

**Nr. 551 005 Universal-Bandschlüssel**

Code: OE580000058



Fits universal for oil filter and dehydrator cartridges, 1/2" drive, max diam. 180mm. Special need for caterpillar.

**Universal Belt Wrench**



## US-SEITENSCHNEIDER CUTTING PLIER



Nr. CHA-447 US-Seitenschneider 200mm

Code: OE590000059



Cutting Plier 200mm

Nr. CHA-449 US-Seitenschneider 250mm

Code: OE670000067

Cutting Plier 250mm



## US-WASSERPUMPENZANGE PLIER



Nr. CHA-426 US-Wasserpumpenzange 165mm

Code: OE236002360



Plier 165mm

Nr. CHA-420 US-Wasserpumpenzange 240mm

Code: OE290000029

Plier 240mm

Nr. CHA-440 US-Wasserpumpenzange 300mm

Code: OE440000044

Plier 300mm

Nr. CHA-460 US-Wasserpumpenzange 420mm

Code: OE720000072

Plier 420mm

Nr. CHA-480 US-Wasserpumpenzange 510mm

Code: OE110000110

Plier 510mm



## ÖLFILTERZANGE OIL FILTER PLIER



**CHANNELLOCK Ölfilterzangen zum Lösen festsitzender Ölfilter.** Spezial-Zahnung. Absolut universelle Anwendung. 2-teiliger Satz bestehend aus 300 und 400mm Zange.

**Nr. CHA-OF-1 Ölfilterzange**

Code: OE936009360



**CHANNELLOCK oil filter plier.** Special teeth grip for perfect loosen the oilfilter. Universal application, 300 and 400mm.

**Oil Filter Plier**



## UNIVERSAL GRUBENBRÜCKE, BODENEBCN FLAT TYPE PIT BRIDGE



<b>MÜLLER-WERKZEUG</b> Technische Daten / technical information		
verstellbare Breite / width	mm	870 - 1150
Traglast / loading capacity	Kg	400
Gewicht / weight	Kg	ca. 45

### FLAT TYPE PIT BRIDGE



**Sicherheits-Grubenbrücke passend für Gruben ohne Schienenführung.**  
 Optionale Sicherheitsbügel. Rutschfestes Gitterrost. Alle Teile kunststoffbeschichtet in Signalfarbe. Gefordert nach den Sicherheitsregeln der deutschen Berufsgenossenschaft BGR 157, 5.6 (5.6.5).  
 Made in Germany.

**Nr. EQ-510 050/BE Universal Grubenbrücke, bodeneben, inkl. Sicherheitsgeländer**  
 Code: OE678000678

**Nr. EQ-510 050/BEG Universal Grubenbrücke, bodeneben, ohne Sicherheitsgeländer**  
 Code: OE498000498



**Due to its adjustable width, the safety pitbridge fits for nearly all pit distances.**  
 Optional safety rails. Made in Germany.

**Truck pit bridge with handrail, flat type**

**Truck pit bridge no handrail, flat type**

## SICHERHEITSGELÄNDER FÜR UNIVERSAL GRUBENBRÜCKE HANDRAIL FOR PIT BRIDGE



**Nr. EQ-510 050/S**  
 Code: OE198000198

**Sicherheitsgeländer-Satz, 2-tlg.**



**Nr. EQ-510 050/S**  
 Code: OE198000198

**Handrail, 2 pcs.**

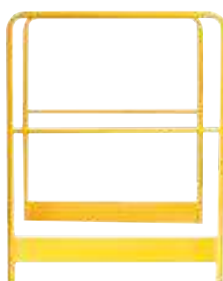

## UNIVERSAL GRUBENBRÜCKE RAIL TYPE PIT BRIDGE



<b>MÜLLER-WERKZEUG</b> Technische Daten / technical information		
verstellbare Breite / width	mm	870 - 1150
Traglast / loading capacity	Kg	400
Gewicht / weight	Kg	ca. 45

### RAIL TYPE PIT BRIDGE



**Sicherheits-Grubenbrücke passend für Gruben mit Schienenführung.** Optionale Sicherheitsbügel. Rutschfestes Gitterrost. Alle Teile kunststoffbeschichtet in Signalfarbe. Gefordert nach den Sicherheitsregeln der deutschen Berufsgenossenschaft BGR 157, 5.6 (5.6.5). Made in Germany.

**Nr. EQ-510 050 Universal Grubenbrücke inkl. Sicherheitsgeländer**  
Code: OE678000678

**Nr. EQ-510 050/G Universal Grubenbrücke ohne Sicherheitsgeländer**  
Code: OE498000498



**Due to its adjustable width,** the safety pitbridge fits for nearly all pit distances. Optional safety rails. Made in Germany.

**Truck pit bridge rail type, with handrail**

**Truck pit bridge rail type, no handrail**

## SICHERHEITSGELÄNDER FÜR UNIVERSAL GRUBENBRÜCKE HANDRAIL FOR PIT BRIDGE



**Nr. EQ-510 050/S**  
Code: OE198000198  
**Sicherheitsgeländer-Satz, 2-tlg.**



**Nr. EQ-510 050/S**  
Code: OE198000198  
**Handrail, 2 pcs.**

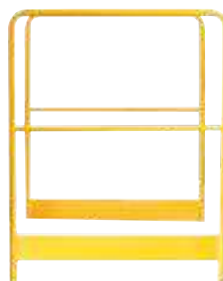

**SICHERHEITS-MONTAGETRITT**  
**SAFETY MOUNTING STEP**

**Rutschfestes und feuerverzinktes Gitterrost**  
 Anti-slip and hot-dip galvanised gridiron

**Schräggestellte Standfüße verhindern ein Kippen**  
 Can not slip thanks to cocked feet



 **Kein Kippen durch schräggestellte Standfüße.** Rutschfestes, feuerverzinktes Gitterrost. DIN 50976. Massive, verwindungssteife Stahlrohrkonstruktion. Für den täglichen, professionellen Werkstatteinsatz.

**Nr. 510 051** **Sicherheits-Montagetrift,**  
 Code: OE153000153 **2-stufig**

**Nr. 510 051/A2** **Sicherheits-Montagetrift,**  
 Code: OE298000298 **2-stufig, 2 Stk.**

 **Can not slip thanks to cocked feet.** Anti-slip, hot-dip galvanised gridiron. DIN 50976. Solid, non-distorting steel tube construction. For daily professional garage use.

**Safety mounting step**

**Safety mounting step, 2 pcs.**

## 1/2" x 600mm KNARREN-KNEBEL 1/2" x 600mm RATCHET BREAKER BAR



Für festsitzende Schraubverbindungen. Schwenkkopf 210° für schwer zugängliche Stellen.

**Nr. 512 610 1/2" x 600mm**  
Code: OE65000065 **Knarren-Knebel**

Nr. 512 611 Ersatzschwenkkopf mit  
Code: OE46000046 Knarrenfunktion 1/2"



Busts loose stubborn bolts. Swivel head design allows multiple positions, including the ability to use it straight as a speed handle for hard to reach areas.

**1/2" x 600mm**  
**Ratchet breaker bar**

Ratchet angle head 1/2"

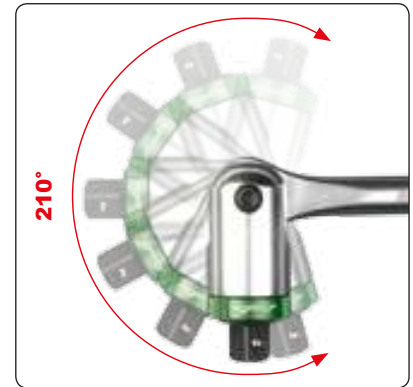

**Universalwerkzeug für festsitzende Schraubverbindungen.**

**Nr. 512 630 Knebel 700mm x 3/4"**  
Code: OE118000118

Nr. 512 631 Ersatzschwenkkopf 3/4"  
Code: OE58000058



**Universal tool for tight screw connections.**

**Breaker bar 700mm x 3/4"**

Swivel Head 3/4"

## KNEBEL 3/4" BREAKER BAR 3/4"



Zum schnellen, sauberen und problemlosen Entlüften (Befüllen) der Dieselfilter sämtlicher Fahrzeuge. Beim Filterwechsel, leergefahrenem Tank, falsch getankt...

Mit Betätigung des Hebels wird ein Vakuum im Dieselfilter-Füllgerät erzeugt. Dieses Vakuum wird durch die Spezialschläuche an den Dieselfilter "weitergegeben". Somit wird vom Tank her der Kraftstoff angesaugt. **Ergonomische Entleerung, integriertes Vakuum-Manometer. Vakuumstärke stufenlos regulierbar.** Durch die verschiedenen Schläuche universell passend.

**Anschluss am Vorlauf, vom Dieselfilter zum Motor.**

**Nr. 515 007/V2 Dieselfilter-Füllgerät**  
Code: OE158000158



## DIESELFILTER-FÜLLGERÄT V2 DIESEL FILTER FILLER V2

**Especially for quick, clean and problem free bleeding of diesel filter (filling of the diesel filter).**

Universally for all cars diesel filter changing, as for empty driven tank. Different hoses guarantee universal fitting. Connect at the line diesel to engine.

**Diesel filter filler**

## LEITUNGSSCHLÜSSELSATZ CROW FOOT WRENCH KIT



**Spezial-Leitungsschlüssel Satz** zum universellen Einsatz an z.B. PKW, LKW, Baumaschinen, landwirtschaftlichen Maschinen etc.

12-kant Maul ermöglicht ein kurzes Nachgreifen und ist für Arbeiten an schwer zugänglichen Stellen geeignet.

9-tlg. 19, 21, 22, 24, 27, 30, 32, 36 und 41mm, z.B. für Hydraulikleitungen, Bremsleitungen, Einspritzleitungen etc.

**Nr. 571 250 Leitungsschlüsselsatz, 19-41mm**

Code: OE178000178



**Special kit for universal use** at cars, trucks, plant machines, agriculture.

12-point profile for hard to reach areas.

9 pcs. kit, 19, 21, 22, 24, 27, 30, 32, 36 and 41mm

e.g. hydraulic, brake injection lines etc.

**Nr. 571 250 Crow foot wrench kit, 19-41mm**

Code: OE178000178



**Sondergrößen auf Anfrage.**

Ask for different sizes.



**Nr. 603 718**  
M18x1,5

**Nr. 603 720**  
M20x1,5

**Nr. 603 722**  
M22x1,5



**Stahlhülsen mit Innengewinde** zur schnellen und genauen Montage mittenzentrierter Räder (Steilschulterräder). Beschädigungen an Radgewinde und Radmutter werden vermieden. Satz bestehend aus je 3 Zentrierhülsen. In folgenden Größen erhältlich: M18x1,5, M20x1,5 + M22x1,5.

**Nr. 603 718 LKW-Zentrierhülsen M18x1,5** 3-tlg.

Code: OE890000089

**Nr. 603 720 LKW-Zentrierhülsen M20x1,5** 3-tlg.

Code: OE890000089

**Nr. 603 722 LKW-Zentrierhülsen M22x1,5** 3-tlg.

Code: OE890000089

## LKW-ZENTRIER- UND GEWINDE-SCHUTZHÜLSEN CENTER SLEEVE KIT



**Center sleeves kit** with inner thread for the exact mounting of truck wheels. No damage of thread. M18x1,5, M20x1,5 + M22x1,5. Each kit includes 3 sleeves.

**Center sleeve kit M18x1,5**

**Center sleeve kit M20x1,5**

**Center sleeve kit M22x1,5**





## KUGELGELENKABZIEHER BALL JOINT SEPARATOR

### Aufnahmeadapter für Spindel

**Nr. 609 103/A**  
Code: OE137000137



### 12 to. Hydraulik Spindel

**Nr. 609 210**  
Code: OE164000164



### Spindel M24x3

**Nr. 609 003/E**  
Code: OE390000039



### Spezial Gewindefett

**Nr. 609 050**  
Code: OE500000005



**Nr. 609 003**

Gabelöffnung / width: 36mm  
Maultiefe / depth: 50mm  
max. Höhe / max. height: 70mm



**Nr. 609 103**



**Hochwertiger und massiver hydraulischer Abzieher** für Kugelgelenke am LKW. Enorme Leistung durch integrierte 12Tonnen Hydraulikspindel und Hebelübersetzung.

**Nr. 609 003 Kugelgelenkabzieher mechanisch**  
Code: OE148000148

**Nr. 609 103 Kugelgelenkabzieher hydraulisch 12 to.**  
Code: OE278000278



**Top quality hydraulic ball joint separator** for trucks. Enormous power based on 12 ton hydraulic spindle and lever transfer.

**Ball joint separator**

**Ball joint separator hydraulic 12 to.**



**Dreh-Schlagimpuls** durch Verwendung von Schlagschrauber. Dieser Dreh-Schlagimpuls hat die selbe Wirkung wie z. B. ein kräftiger Hammerschlag. Insbesondere bei Kegelsitzverbindung ist diese Abziehmethode weitaus effektiver als bisherige Hebelabzieher. 35mm Abziehglocke speziell für VW LT und DB Sprinter.

**Nr. 609 035 Abziehglocke 35mm**  
Code: OE298000298

**Nr. 609 039 Abziehglocke 39mm**  
Code: OE268000268



**VIBRO-IMPACT® princip through power gun drive.** This VIBRO-IMPACT® has the same result as a hammer beat. Especially cone seat connections can be separated much quicker then traditional pullers.

**Nr. 609 035 Bell shape 35mm**  
Code: OE298000298

**Nr. 609 039 Bell shape 39mm**  
Code: OE268000268

## VIBRO-IMPACT® ABZIEHGLOCKEN VIBRO-IMPACT® BELL SHAPE SEPARATOR



**Nr. 609 039**  
z.B. e.g. **DB 1424**



**Nr. 609 039**  
z.B. e.g. **DB Actros 2**



**Nr. 609 035**  
z.B. e.g. **DB Sprinter / VW LT**



**Gehärtet + vergütet**  
Hardened + coated

**Schlagschrauberfeste Trapezgewindespindel**  
Square thread spindle  
impact proofed

**Druckstück kugelgelagert**  
Ball beared press piece

OPTION HYDRAULIK  
ab Seite 8-35  
OPTION HYDRAULIC  
on page 8-35

**XS DRUCK- UND ZUGHÜSENSATZ**  
**XS PRESS AND PULL SLEEVE KIT**



**Druckhülsen Ø Innen:**  
**14 - 32 mm 9/16" - 1-1/4"**  
Sleeves inner Ø:  
14 - 32 mm 9/16" - 1-1/4"



Nr. 609 390

**Hochwertige Spindel**  
Spindle with rolled thread

**Druck-/Zughülse**  
Sleeve

**Querlenker**  
Control arm

**Stufenscheibe**  
Hardened Step Disc

**Druck-/Zughülse**  
Sleeve

**Druckmutter mit Lager**  
Nut with Ball Bearing



**Hülsen können mit Nr. 609 400 kombiniert werden.**

Sleeves can be stacked with no. 609 400 sleeves



**Universal Werkzeugsatz zum Aus- und Einziehen** von Silentlagern, Hydrolagern, Buchsen, Kugellagern, Simmeringen, Gummilagern und Traggelenken. Verwendbar als Präzisions-Druckstücke für die Werkstattpresse. Kombinierbar mit Pressrahmen, C-Bügel etc. Ideal auch zur Verwendung mit dem Original MÜLLER Druck- und Zughülsensatz 609 400.

**Nr. 609 390**  
Code: OE398000398

**XS Druck- und Zughülsensatz**

**Nr. 609 390/Basic XS Ergänzungssatz für Nr. 609 400**



**Universal tool set for extracting and mounting:** silent bearings, hydraulic bearings, ball bearings, rubber bearings, shaft seals, bearing bushes etc. Universal application makes it ideal for a range of vehicles. Ideal to use in combination with the 609 400 press and pull sleeve kit.

**XS press and pull sleeve kit**  
(10 sleeves, 3 spindles, 4 discs)

**Basic XS press and pull sleeve kit**  
(10 sleeves, 1 spindle) **Kombi kit for no. 609 400**

## UNIVERSAL DRUCK- UND ZUGHÜSENSATZ TYP 1 UNIVERSAL PRESS AND PULL SLEEVE KIT TYPE 1



**Druckhülsen Ø Innen: 34 - 72mm**  
Sleeves inner Ø: 34 - 72mm



WATCH DEMO HERE:



**Universal Werkzeugsatz** zum Aus- und Einziehen von: Silentlagern, Hydrolagern, Buchsen, Kugellagern, Simmeringen, Gummilagern etc. Absolut universelle Anwendung. Ideal für unterschiedliche KFZ.

**Nr. 609 400 Universal Druck- und Zughülsensatz Typ 1**  
Code: OE498000498



**Universal tool set** for extracting and mounting in: silent bearings, hydraulic bearings, bearing bushes, ball bearings, shaft seals, rubber bearings etc. Fully universal application. Ideal for different vehicles.

**Universal press and pull sleeve kit type 1**

OPTION HYDRAULIK  
ab Seite 8-35

OPTION HYDRAULIC  
on page 8-35

## UNIVERSAL DRUCK- UND ZUGHÜLSEN-KOMPLETTSATZ UNIVERSAL PRESS AND PULL COMBINATION KIT



WATCH DEMO HERE:



Dieser Satz vereint in einem Koffer unseren Universal Druck- und Zughülsensatz (Nr. 609 400) und unseren original **VIBRO-IMPACT®** C-Bügel (Nr. 609 460). Zusätzlich enthält dieser Satz noch eine kurze Trapezgewinde-Spindel TR20 mit Druckmutter sowie die entsprechenden Konter-Muttern.

### Anwendungen z. B.:

- Silentlager
- Kugellager
- Radlager
- Gummi-Lager
- Hydro-Lager
- Dichtungen
- etc.



### The #1 Press & Pull kit on the market!

- Our complete package! 20 Sleeves / 4 Discs!
- Sleeves can be stacked.
- Sleeves outer diameter range: 1-3/4" – 3-1/8"
- Including XL C-Clamp
- Includes **VIBRO-IMPACT®** Tool, allowing the use of an impact wrench
- Comes in a convenient carry case.

### Applications:

- Remove/Install:
- Silent Bearings
  - Ball Bearings
  - Rubber Bearings
  - Hydraulic Bearings
  - Shaft Seals/Bearing Bushings
  - etc.

**Nr. 609 400/460 Universal Druck- und Zughülsen-Komplettatz**  
Code: OE94800948

**Press and Pull Sleeve Combination Kit**

## UNIVERSAL DRUCK- UND ZUGHÜSENSATZ TYP 2 UNIVERSAL PRESS AND PULL SLEEVE KIT TYPE 2



**Druckhülsen Ø Innen: 74 - 112mm**  
Sleeves inner Ø: 74 - 112mm



**Universal Werkzeugsatz** zum Aus- und Einziehen von: Silentlagern, Hydrolagern, Buchsen, Kugellagern, Simmeringen, Gummilagern etc. Absolut universelle Anwendung. Ideal für unterschiedliche Fahrzeuge, Transporter und LKW.



**Nr. 609 420 Universal Druck- und ZughüSENSATZ Typ 2**  
Code: OE138001380



**Universal tool set** for extracting and drawing in: silent bearings, hydraulic bearings, bearing bushes, ball bearings, shaft seals, rubber bearings etc. Fully universal application. Ideal for different vehicles, heavy duty and trucks.

**Universal press and pull sleeve kit type 2**

## EINZELTEILE FÜR DRUCK- UND ZUGHÜSENSATZ SPARE PARTS FOR PRESS AND PULL SLEEVE KIT

Art.-Nr. no.	Durchmesser Außen outside diameter	Durchmesser Innen inner diameter			609 390 XS Druck- und Zughülsen-Satz 609 390 XS press and pull sleeve kit	609 390/Basic XS Druck- und Zughülsen-Satz (Kombisatz zu 609 400) 609 390/Basic XS press and pull sleeve kit (Kombi kit for no. 609 400)	609 390/10 XS Druck- und Zughülsen 10 tlg. 609 390/10 XS press and pull sleeve kit 10 pcs.
							
609 390-14/24	24,00 mm	14,00 mm	XS-Stufen-Druckhülse 14/24	XS-Sleeve 14/24	x	x	x
609 390-16/26	26,00 mm	16,00 mm	XS-Stufen-Druckhülse 16/26	XS-Sleeve 16/26	x	x	x
609 390-18/28	28,00 mm	18,00 mm	XS-Stufen-Druckhülse 18/28	XS-Sleeve 18/28	x	x	x
609 390-20/30	30,00 mm	20,00 mm	XS-Stufen-Druckhülse 20/30	XS-Sleeve 20/30	x	x	x
609 390-22/32	32,00 mm	22,00 mm	XS-Stufen-Druckhülse 22/32	XS-Sleeve 22/32	x	x	x
609 390-24/34	34,00 mm	24,00 mm	XS-Stufen-Druckhülse 24/34	XS-Sleeve 24/34	x	x	x
609 390-26/36	36,00 mm	26,00 mm	XS-Stufen-Druckhülse 26/36	XS-Sleeve 26/36	x	x	x
609 390-28/38	38,00 mm	28,00 mm	XS-Stufen-Druckhülse 28/38	XS-Sleeve 28/38	x	x	x
609 390-30/40	40,00 mm	30,00 mm	XS-Stufen-Druckhülse 30/40	XS-Sleeve 30/40	x	x	x
609 390-32/42	42,00 mm	32,00 mm	XS-Stufen-Druckhülse 32/42	XS-Sleeve 32/42	x	x	x
609 400/P1			Stufenplatte Nr. 1	Step Disc No. 1	x		
609 400/P2			Stufenplatte Nr. 2	Step Disc No. 2	x		
609 400/P3			Stufenplatte Nr. 3	Step Disc No. 3	x		
609 400/P4			Stufenplatte Nr. 4	Step Disc No. 4	x		
609 400/S10			Spindel M10 ohne Mutter	Spindle M10 without Nut	x		
609 400/S12			Spindel M12 ohne Mutter	Spindle M12 without Nut	x		
609 400/D10			Druckmutter M10 mit Lager	Nut M10 with Bearing	2x		
609 400/D12			Druckmutter M12 mit Lager	Nut M12 with Bearing	2x		
609 420/TR20K			Spindel TR 20, kurz mit Adaptergewinde innen M10, M12, M14	Spindle TR 20, short with inside adapter thread M10, M12, M14	x	x	
609 420/TR20M			Druckmutter TR20 mit Lager	Nut TR20 with Bearing	x	x	
609 420/M10			Kontermutter M10	Counter Nut M10	x	x	
609 420/M12			Kontermutter M12	Counter Nut M12	x	x	
906 007			Spezial-Schmiermittel	Special lubricant	x	x	
609 390-1			Koffer für 609 390	Blow case for 609 390	x	x	



Nr. 609 390/Basic

# EINZELTEILE FÜR DRUCK- UND ZUGHÜSENSATZ

## SPARE PARTS FOR PRESS AND PULL SLEEVE KIT

Art.-Nr. ID.	609 420	609 420/ Upgrade	609 420/ Basic	609 400/ 460	609 400		
609 400				x	x		
609 400-34/44				x	x		
609 400-36/46				x	x		
609 400-38/48				x	x		
609 400-40/50				x	x		
609 400-42/52				x	x		
609 400-44/54				x	x		
609 400-46/56				x	x		
609 400-48/58				x	x		
609 400-50/60				x	x		
609 400-52/62				x	x		
609 400-54/64				x	x		
609 400-56/66				x	x		
609 400-58/68				x	x		
609 400-60/70				x	x		
609 400-62/72				x	x		
609 400-64/74				x	x		
609 400-66/76				x	x		
609 400-68/78				x	x		
609 400-70/80				x	x		
609 400-72/82				x	x		
609 400/D10	2x	2x		2x	2x		
609 400/D12	2x	2x		2x	2x		
609 400/D14	2x	2x		2x	2x		
609 400/D16				2x	2x		
609 400/K					x		
609 400/P1				x	x		
609 400/P2				x	x		
609 400/P3				x	x		
609 400/P4				x	x		
609 400/S10	x	x		x	x		
609 400/S12	x	x		x	x		
609 400/S14	x	x		x	x		
609 400/S16	x	x		x	x		
609 400/460/K				x			
609 420							
609 420-1	x		x				
609 420-100/110	x		x				
609 420-102/112	x		x				
609 420-104/114	x		x				
609 420-106/116	x	x					
609 420-108/118	x	x					
609 420-110/120	x	x					
609 420-112/122	x	x					
609 420-74/84	x	x					
609 420-76/86	x	x					
609 420-78/88	x	x					
609 420-80/90	x	x					
609 420-82/92	x		x				
609 420-84/94	x		x				
609 420-86/96	x		x				
609 420-88/98	x		x				
609 420-90/100	x	x					
609 420-92/102	x	x					
609 420-94/104	x	x					
609 420-96/106	x	x					
609 420-98/108	x		x				
609 420/A	2x		2x				
609 420/Basic			x				
609 420/D16	2x	2x					
609 420/M10	x		x	x			
609 420/M12	x		x	x			
609 420/M14	x		x	x			
609 420/P1	x		x				
609 420/P2	x		x				
609 420/P3	x		x				
609 420/P4	x		x				
609 420/TR20K	x		x	x			
609 420/TR20L	x		x				
609 420/TR20M	x		x	x			
609 420/Upgrade		x					

## UNIVERSAL PRESSRAHMEN UNIVERSAL BASE FRAME



200mm

**Nr. 609 115**

Code: OE218000218

**Universal Pressrahmen**

Universal base frame



350mm

**Nr. 609 120**

Code: OE298000298

**Universal Pressrahmen  
inkl. Adapter-Satz  
passend für 609 400**

Universal base frame incl.  
adapter- kit fits for 609 400



**Nr. EQ-609 710**

**Integral-Hydraulikspindel 10 to.**  
Combined Hydraulic Spindle 10 tons.

## DRUCKSTÜCKSÄTZE FÜR KUGELBOLZEN PRESSURE PIECE KIT FOR BALL JOINT



**Nr. 609 137**



**Druckstücksätze für Universal-Pressrahmen** zur  
Demontage von Traggelenken (Kugelbolzen).

**Nr. 609 144**

Code: OE178000178

**VW T4 ab Bj. '92**

Aus- und Einbau Traggelenk oberer Quer-  
lenker, Anwendung direkt am Fahrzeug.

**Nr. 609 147/V2**

Code: OE238000238

**VW LT + DB Sprinter** ab Bj. '06

Aus- und Einbau Traggelenk Ø 45mm,  
Anwendung direkt am Fahrzeug

**Nr. 609 149**

Code: OE219000219

**Renault Master/Opel Movano**

Aus- und Einbau Traggelenk Vorderachse  
oben, Anwendung direkt am Fahrzeug.

**Nr. 609 150**

Code: OE219000219

**Renault Master/Opel Movano**

Aus- und Einbau Traggelenk Vorderachse  
unten, Anwendung direkt am Fahrzeug.



**Pressure piece kits for universal press frame** to  
dismantling the suspension joints (ball joint).

**VW T4 from '92**

direct on-vehicle dismantling/  
installation, suspension joint top wishbone

**VW LT + DB Sprinter**

direct on-vehicle dismantling/  
installation, Ø45mm suspension joint

**Renault Master/Opel Movano**

direct on-vehicle  
dismantling/installation, top suspension joint

**Renault Master/Opel Movano**

direct on-vehicle  
dismantling/installation, bottom suspension joint





# HYDRAULIK HOHLKOLBEN-ZYLINDER UND -ANTRIEB HOLLOW PISTON HYDRAULIC-CYLINDER

**Fuß- und Handbetätigung**  
Hand- and feet operations



**Schlauchlänge: 2m**  
Hose-length: 2m

**Nr. EQ-700**



**Nr. EQ-300 014**  
**Hydraulik-Handpumpe**  
**700 bar**  
Hydraulic pump 700 bar

**Nr. 300 011**  
**Zugspindel M16x500mm mit Muttern und Kugelscheiben**  
Spindle M16x500mm with nuts and rounded washer



**Nr. 300 017**  
**Zugspindel M20x500mm mit Muttern und Kugelscheiben**  
Spindle M20x500mm with nuts and rounded washer



**Nr. 300 120**  
**20 to. Hohlkolben-Zylinder**  
**Ø 26,0mm**  
20 to. hollow piston cylinder  
Ø 26,0mm



**Nr. 300 015**  
**700 bar Hydraulik-Schlauch, 2m**  
700 bar hydraulic-hose, 2m



**Hydraulik-Hohlkolben-Zylinder in 12 und 20 to.** Ausführung erhältlich. Extrem hoher und gleichmäßiger Kraftaufbau. Zylinderbohrung ermöglicht sowohl Druckkraft als auch Zugkraft in Verbindung mit entsprechender Spindel.  
(12 to. Zylinder/ M16 Spindel, 20 to. Zylinder/ M20 Spindel)

**Nr. 300 120** **Hydraulik-Hohlkolbenzylinder 20 to.**  
Code: OE980000980

**Nr. 300 011** **Zugspindel für Hydraulik**  
**M16 x 500mm**  
Code: OE900000090

**Nr. 300 017** **Zugspindel für Hydraulik**  
**M20 x 500mm**  
Code: OE900000090

**Nr. 300 015** **Hydraulik-Schlauch 700 bar, 2m**  
Code: OE128000128

**Nr. EQ-700** **Pneumatik / Hydraulik-Einheit**  
**700 bar**  
Code: OE438000438

**Nr. EQ-300 014** **Hydraulik-Handpumpe 700 bar**  
Code: OE388000388



**Hollow piston hydraulic cylinder designed in 12 to. or 20 to.** High pull or push force of 12 to. or 20 to. will be generated evenly. Hollow piston construction.  
(12 to. cylinder / M16 spindle, 20 to. cylinder / M20 spindle)

**Hollow piston 20 to.**

**Spindle for hydraulics**  
**M16 x 500mm**

**Spindle for hydraulics**  
**M20 x 500mm**

**Hydraulic hose 700 bar, 2m**

**Pneumatic-hydraulic unit 700 bar**

**Hydraulic pump 700 bar**

## HYDRAULIK-SET 20 TO. HYDRAULIC-SET 20 TO.

### Hochfeste Spindel, M20x500mm mit Muttern und Kugelscheiben

Spindle M20x500mm with  
nuts and rounded washer

### Hochdruckschlauch, 700bar, 2m

Hose, 700bar, 2m

### Schnellverbindungs-Kupplung

Quick-chuck

### Pneumatik- Hydraulik-Einheit, Fußbetätigung, 700bar

Pneumatic-hydraulic-unit,  
foot control, 700 bar

Nr. EQ-700

### Zylinder-Hub: 52mm

Cylinder-hub: 52mm



**20 to. Hydraulik-Set, ideales Kombinationswerkzeug**  
für Druck- und Zughülsensatz Typ I+II. Hydraulik-Hohlkolben-  
Zylinder. Hoher und gleichmäßiger Kraftaufbau. Zylinderbohrung  
ermöglicht sowohl Druckkraft als auch Zugkraft in Verbindung  
mit entsprechender Spindel.

Optional: Spindel in verschiedenen Längen lieferbar.

**Nr. EQ-320/700 Hydraulik-Set pneumatisch 20 to.**

Code: OE117601176

Lieferung komplett in Box.



**20 to. Hydraulic-set. Perfect combination-tool**  
for press and pull sleeve kit type I+II. High pull or push of 20 to.  
will be generated evenly. Hollow piston construction. 700 bar  
foot pump.

**Hydraulic-set with pneumatic pump 20 to.**

# 10 to. INTEGRAL-HYDRAULIKSPINDEL COMBINED HYDRAULIC SPINDLE

**TOOL-INNOVATION  
2016**



**Neuartige und innovative Hydraulikspindel mit integrierter Hochdruckpumpe und einem Lasthub von 85mm.** Messbare 10 Tonnen Druckleistung. Alle uns bekannten Fett- und Öl-Hydraulikspindeln haben nur einen Lasthub zwischen 5 und 12 mm. Handgriff ist 360° drehbar und abnehmbar. Das integrierte Überdruck-Sicherheitsventil öffnet ab 10 Tonnen, und die Einheit kann nicht überlastet werden. Die Ölhydraulik funktioniert in jeder Position, also auch über Kopf. Für den Kolben mit Federrückzug gibt es optional auch weitere Druckstücke. Passend für alle am Markt gängigen Abzieher, Flansche, Vorrichtungen etc... mit Gewinde UN1-1/2".

Also z. B. auch passend für Sauer, Sykes Pickavant, KS-Tools, Friweg, FW-Hanse, Kukko, Nexus, Facom, DB, MAN...

**Nr. EQ-609 710 Integral-Hydraulikspindel 10 to.**  
Code: OE398000398

**Nr. EQ-609 710/3 Integral-Hydraulikspindel 3er Pack**  
Code: OE119401194



**Unique and combined high pressure pump and hydraulic spindle 10 tons and a stroke of 85mm.** Measurable 10 tons of pressure capacity. All the hydraulic spindles we know, which operate with oil or grease, only have a stroke of 5 to 12 mm. The handle can be rotated 360° and is removable. The integrated pressure relief control valve opens at 10 tons and the unit cannot be overloaded. The oil hydraulics works in any position, even upside down. The piston has a spring return, and optional additional plungers are available.

Suitable for use with all available current market pullers, flanges, fixtures etc., with thread UN 1-1/2".

Therefore, e.g. suitable for Sauer, Sykes Pickavant, KS-Tools, Friweg, FW-Hanse, Kukko, Nexus, Facom, DB, MAN etc.

**Nr. EQ-609 710 Combined Hydraulic Spindle 10 tons.**  
Code: OE398000398

**Nr. EQ-609 710/3 Combined Hydraulic spindles, pack of 3**  
Code: OE119401194

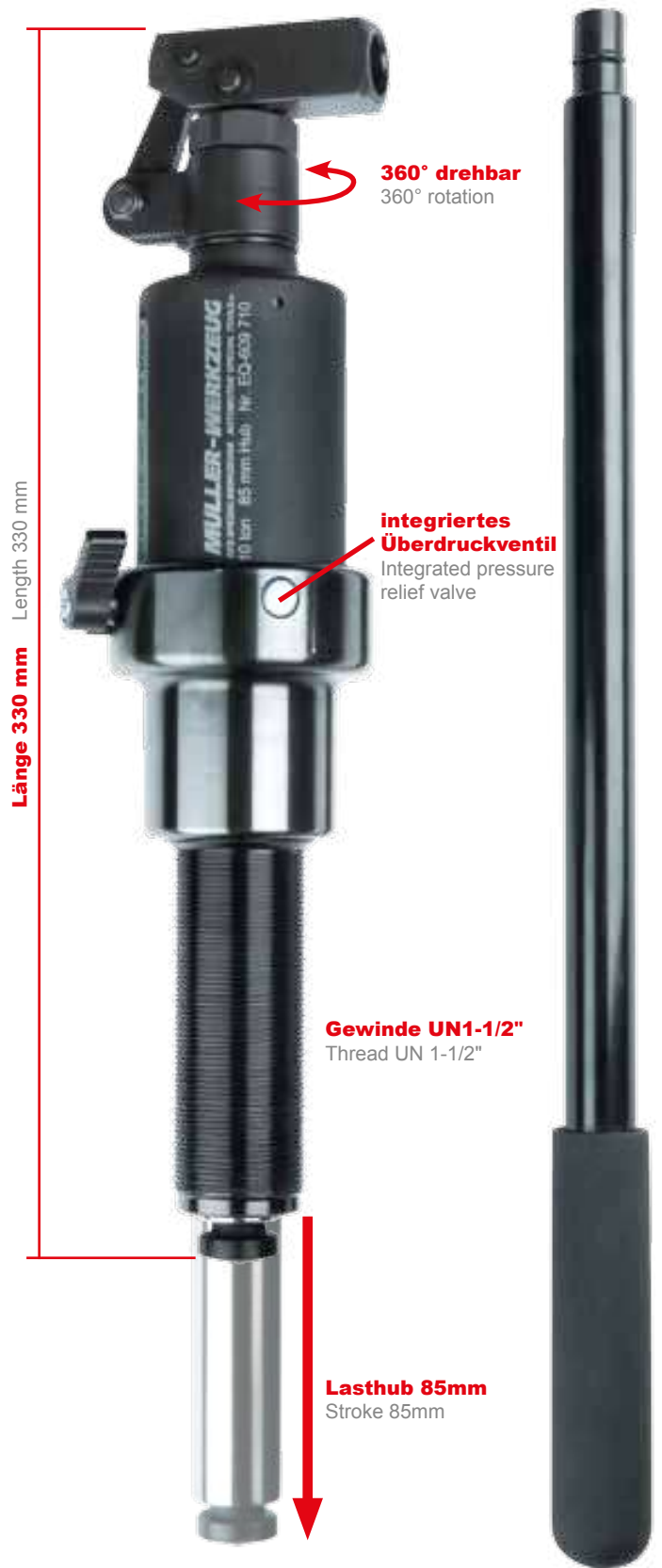

**UNIVERSAL-ANWENDUNGEN**  
**UNIVERSAL SYSTEM**

Optional Nr. 609 460-4:

Adapter für Stufenscheiben  
aus Nr. 609 400

Adapter for stepped pulleys  
from No. 609 400



**2/3 Arm Abzieher**  
**z. B. Sturzeinstellplatte /**  
**Lenkstockhebel**

2/3 legs pullers  
e.g. Wheel camber setting plates  
and Steering/pitman arms



**Universal**  
**Pressrahmen**  
Universal Press frame

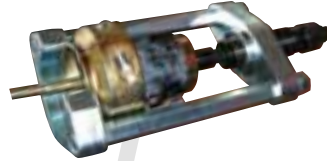

**Aus- und Einbau**  
**Silentlager am Fahrzeug**

Removal and installation  
of suspension bushes/silent  
bearings, on the vehicle



**Abzieher Schwingungsdämpfer**  
Extraction of vibration dampers



**Kombination mit Druck-**  
**und Zughülensätzen**

Combination with pressure sleeve  
and clamping sleeve sets



**LKW**  
**Kugelgelenk-**  
**abdrücker**

Truck ball  
joint splitter

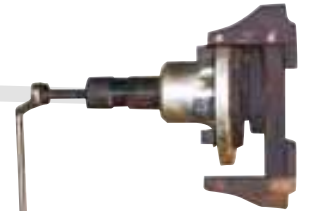

**Antriebswelle aus**  
**Radnabe drücken**

Pressing the drive shaft  
from the wheel hub



**Flanche**  
Flanges



**C-Bügel**  
C-frame



## FUNKTIONSPRÜFLAMPE MULTI-FUNCTION TEST LAMP



**Zur Funktionsprüfung von z. B. Bauteilen, Komponenten, Relais etc.** Austauschbare Spitze 6 - 48 Volt.

- Durchgangsprüfung
- Spannungsprüfung
- Integrierte LED Lampe
- Polaritätsfeststellung
- Fehlerdiagnose
- Thermosicherung etc.

**Nr. 727 006**  
Code: OE780000078

**Funktionsprüflampe,  
6m Kabel**

**Nr. 727 006/25**  
Code: OE112000112

**Funktionsprüflampe,  
25m Kabel**



**For functional testing e. g. assemblies, components, relays etc.** Replaceable probes 6 - 48 volts.

- Continuity test
- Voltage testing
- Integrated LED lamp
- Polarity determination
- Fault diagnosis
- Thermal fuse etc.

**Nr. 727 006**  
Code: OE780000078

**Multi-function Test Lamp,  
6m cable**

**Nr. 727 006/25**  
Code: OE112000112

**Multi-function Test Lamp,  
25m cable**

## AUßENGEWINDE-NACHSCHNEIDER THREAD RESTORER



**Zum Nachschneiden von beschädigten Gewinden** an Wellen, Achsen usw. Kein Schneideisen erforderlich. Mit austauschbaren Strehlerplatten. Geeignet für metrische als auch für Zoll-Gewinde mit Durchmesser zwischen 25 und 140mm.

**Nr. 727 700 Außengewinde-Nachschneider**  
Code: OE278000278



**To restore damaged threads** on axle, shafts etc. No thread die needed. Changeable plates included. Can be used for metric and inch threads with diameters  $\varnothing$  25-140mm.

**Nr. 727 700 Thread restorer**  
Code: OE278000278

**Nr. 727 703**  
Code: OE757007570

Ersatz-Strehlerplatten, metrisch, 2-tlg.  
Thread restorer plate kit, metric

**Nr. 727 704**  
Code: OE128000128

Ersatz-Strehlerplatten, Zoll, 4-tlg.  
Thread restorer plate kit, inch.



**Steigung metrisch / metric**  
1, 1.25, 1.5, 1.75, 2, 2.5, 3, 3.5

**Steigung Zoll / inch**  
4, 5, 6, 7, 7.5, 8, 9, 10,  
11, 11.5, 12, 14, 16,  
18, 20, 24

## UNI VERLÄNGERER TYP 1 + 2 UNI EXTENDER TYPE 1 + 2

### Nr. 745 100/PW

Länge / length: 340mm  
max. SW26 / 26mm



**Ideale Passform**  
Fits perfect

**Perfekt zum Lösen  
festsitzender Sechskant-, TX- oder  
XZN- Verschraubungen**

To loosen tight connection of hex, TX + XZN



### Nr. 745 102

Länge / length: 580mm; max. SW46 / 46mm



**Universal Verlängerung** zum Lösen festsitzender Schraubenverbindungen an schwer zugänglichen Stellen. Passend für Maulschlüssel, Ring-Maulschlüssel, gekröpfte Ringschlüssel etc.



**Uni extender** to loosen tight connection on hard to reach areas.

### Nr. 745 100/PW Uni Verlängerer Typ 1

Code: OE398003980

### Uni extender type 1

### Nr. 745 102 Uni Verlängerer Typ 2

Code: OE118000118

### Uni extender type 2

## SCHNEIDEISEN-ADAPTERSATZ DIE ADAPTER KIT



**Universell geeignet für runde Schneideisen** von M3 bis M24. Spezialwerkzeug für schwer zugängliche Stellen, wie z. B. Auspuff-Stehbolzen etc. Antrieb wahlweise mit 1/2" Knarre, Schraubenschlüssel oder Stecknuss.



### Nr. 767 700 Schneideisen-Adaptersatz

Code: OE108000108



**Can be used universally** for round threads dies M3 - M24. Especially made for hard to reach areas as exhaust studs etc.

Drive with 1/2" ratchet, wrench or socket.

### Nr. 767 700 Die adapter kit

Code: OE108000108

## 3/4" IMPACT STECKNUSS SATZ SOCKET KIT



**Gesenkgeschmiedet.** Lieferung in Schaumstoffeinlage.  
SW24, 27, 30, 32, 33, 36, 41 + Verlängerung 175mm

**Nr. 801 800 3/4" Impact Stecknuss Satz**  
Code: OE188000188



**Drop forged.** Comes with foam inlay.  
24, 27, 30, 32, 33, 36, 41mm + extension 175mm.

**Nr. 801 800 3/4" Impact Socket Kit**  
Code: OE188000188



**Impact Stecknüsse einzeln erhältlich:**

Impact Sockets separately available:

**SW24, long**

Nr. 801 024  
Code: OE380000038

**SW30, long**

Nr. 801 030  
Code: OE380000038

**SW33, long**

Nr. 801 033  
Code: OE420000042

**SW41, long**

Nr. 801 041  
Code: OE580000058

**SW27, long**

Nr. 801 027  
Code: OE380000038

**SW32, long**

Nr. 801 032  
Code: OE420000042

**SW36, long**

Nr. 801 036  
Code: OE480000048

**Nr. 807 005**

Code: OE440000044

**Impact Verlängerung 175mm**  
Impact Extension 175mm

## ANTRIEBSWELLEN STECKNUSS SATZ 3/4" DRIVE SHAFT SOCKET KIT 3/4"



Für 12-kant Muttern z. B. auf Antriebswellen. Extra schwere Ausführung, Antrieb 3/4", Größen 24, 27, 30, 32, 34, 36mm. Lieferung in Schaumstoffeinlage.

**Nr. 801 806 Antriebswellen  
Stecknuss Satz 3/4"**  
Code: OE178000178



Impact version for 12-point nuts i. e. on the drive shafts.  
Extra heavy version, 3/4" drive. Includes with foam inlay.

**Nr. 801 806 Drive shaft socket kit 3/4"**  
Code: OE178000178



## XL-IMPACT ROHRSTECKNÜSSE XL-IMPACT SOCKETS



**Gesenkgeschmiedet aus einem Stück.** Speziell für die Zwillingsbereifung an LKW's. 400mm x 3/4" Antrieb.

**Nr. 805 024** XL-Impact Rohrstecknuss SW24  
Code: OE112000112

**Nr. 805 027** XL-Impact Rohrstecknuss SW27  
Code: OE112000112

**Nr. 805 030** XL-Impact Rohrstecknuss SW30  
Code: OE112000112

**Nr. 805 032** XL-Impact Rohrstecknuss SW32  
Code: OE118000118



**Gesamtlänge: 400mm**

Overall length: 400mm

**Fully massive drop forged.** Special made for the truck twin tires. 400mm x 3/4" drive.

**Nr. 805 024** XL-Impact socket SW24

**Nr. 805 027** XL-Impact socket SW27

**Nr. 805 030** XL-Impact socket SW30

**Nr. 805 032** XL-Impact socket SW32

## STECKNUSS FÜR HYDRAULIK KUPPLUNGEN SPECIAL SOCKET FOR HYDRAULIC COUPLINGS



Nr. 806 038  
Code: OE760000076

Stecknuss für Hydraulik Kupplungen SW38 x 1/2"



Nr. 806 038  
Code: OE760000076

Special socket for hydraulic couplings SW38 x 1/2"



## SCHLAG-VERLÄNGERUNGS-SATZ IMPACT LOCKING EXTENSION KIT



2tlg., 125 + 250mm, 1/2" Antrieb, mit Verriegelung. Ermöglicht einen sicheren und festen Sitz der Stecknuss.

### Nr. 807 020 Schlag-Verlängerungs-Satz

Code: OE480000048

Nr. 807 003  
Code: OE320000032

Schlag-Verlängerung 125mm x 1/2" mit Verriegelung

Nr. 807 004  
Code: OE380000038

Schlag-Verlängerung 250mm x 1/2" mit Verriegelung



2pcs, 125 + 250mm 1/2", with locking mechanism. Ensures safe and tight connection of the impact sockets.

### Impact locking extension kit

Impact locking extension 125mm x 1/2"

Impact locking extension 250mm x 1/2"



## IMPACT GELENKWELLEN 12-KANT-SATZ IMPACT AXLE SHAFT 12-POINT-KIT



**Stecknuss Satz 9 tlg., Schlagausführung** speziell zum Lösen und Anziehen der 12-kant Muttern auf den Antriebswellen. Alle benötigten 12-kant Spezialstecknüsse SW 24, 27, 30, 32, 34, 36 x 1/2" Länge 85 mm für überstehende Gelenkwellegewinde. Lösen und Anziehen des Innen 6-kant Profiles in den Gelenkwellen. Innen 6-kant Stecknüsse SW 14, 17, 19 x 1/2", extra kurz, Länge 34 mm. Komplett im stabilen Kunststoff-Ordnungssystem.

### Nr. 810 500/9 IMPACT Gelenkwellen 12-Kant-Satz, 9-tlg.

Code: OE128000128



**Impact socket kit 12-point.** Especially made to loose and tight the axle shaft nuts. Hex sockets for the inner profile. Will be supplied with plastic storage.

### Nr. 810 500/9 IMPACT Axle shaft 12-point-kit, 9 pcs.

Code: OE128000128





## KRAFT-KUGELGELENK- STECKNUSS-SATZ IMPACT BALL JOINT SOCKET KIT



**Speziell zur Verwendung an Radaufhängungen, Stoßdämpfern, Bremsen etc.** Kugelgelenk 30° abwinkelbar. Schlagschrauberfest.

**Nr. 810 303 Kraft-Kugelgelenk-Stecknuss-Satz, 3-tlg. SW21, 22, 24 x 1/2"**  
Code: OE98000098

**Nr. 810 689 Kraft-Kugelgelenk-Stecknuss-Satz, 4-tlg. SW16, 17, 18, 19 x 1/2"**  
Code: OE109000109



**Perfect for axle connections, shock absorbers, brakes etc.** Ball joint 30° swivel. Impact gun resistant.

**Impact ball joint socket kit, 3pcs. 21, 22, 24mm x 1/2"**

**Impact ball joint socket kit, 4pcs. 16, 17, 18, 19mm x 1/2"**



Nr. 810 689

## XS-STUBBY IMPACT SATZ EXTRA KURZ XS-STUBBY IMPACT SOCKET KIT 10-24MM ON RAIL



**Alle Nüsse einzeln erhältlich (siehe Preisliste).** All parts separately available (see price list).



**Ideal zur Verwendung an schwer zugänglichen Stellen durch die einzigartige extra kurze Bauhöhe. 15-tlg.** Lieferung komplett auf Steckleiste.

**Nr. 810 700 XS-Stubby Impact Satz extra kurz, Antrieb 1/2" 10-24mm auf Leiste**  
Code: OE98000098



**Ideal to access hard to reach areas based on the unique short construction. 15-pcs.** Delivery on rail.

**XS-Stubby Impact socket kit 10-24mm on rail**



28 mm  
extra kurz  
extra short

## DUO DRIVE®

### STECKNUSS-SATZ SOCKET KIT



Das **DUO DRIVE®** System ermöglicht den Einsatz verschiedener Schlagschrauber (z.B. 1/2", 3/4" etc.), sowie die Verwendung von Ring- und Maulschlüssel etc.

**Nr. 810 808 Stecknuss-Satz XZN-Impact, 8-tlg.**  
Code: OE88000098



The **DUO DRIVE®** is made to be used with 1/2" + 3/4" impact wrenches. As well you can use it with wrenches.

**Nr. 810 808 Socket kit XZN-impact 8 pcs.**  
Code: OE88000098

**Antrieb: 1/2" + SW24**  
Drive:  
1/2" + 24mm

**Größen: M12, M14, M16, M18**  
Sizes: M12, M14, M16, M18

**Länge: 40mm**  
Length:  
40mm

**Länge: 75mm**  
Length: 75mm



**Vielzahl-Stecknuss einzeln erhältlich.** Sockets are separately available.

<b>M12</b> Nr. 810 812 Code: OE20000020	<b>M14</b> Nr. 810 814 Code: OE22000022	<b>M16</b> Nr. 810 816 Code: OE24000024	<b>M18</b> Nr. 810 818 Code: OE26000026
<b>M12</b> Nr. 810 822 Code: OE28000028	<b>M14</b> Nr. 810 824 Code: OE30000030	<b>M16</b> Nr. 810 826 Code: OE32000032	<b>M18</b> Nr. 810 828 Code: OE34000034

## MOTOR-DURCHDREHVORRICHTUNG ENGINE TURNING TOOL



**Spezial Vorrichtung zum Durchdrehen des Motors** im Stand. In zwei Ausführungen erhältlich: Nr. 826 000 für DB + MAN 12-Zylinder LKW, Nr. 826 002 für DB Actros, Atego und MAN-Motoren, außer 12 Zylinder.

**Nr. 826 000 Motor-Durchdrehvorrichtung 12 Zylinder**  
Code: OE134000134

**Nr. 826 002 Motor-Durchdrehvorrichtung**  
Code: OE168000168



Nr. 826 002



**Special unit to turn the engine.**  
Two different types available.  
No. 826 000 fits for DB + MAN 12-cylinder.  
No. 826 002 fits for DB Actros, Atego + MAN-engines.

Nr. 826 000

**Engine turning tool 12 cylinder**

**Engine turning tool**

## KUNSTSTOFFROHRSCNEIDER PVC-HOSE CUTTER



**Zum sauberen Abschneiden von Kunststoffleitungen** aller Art wie z. B. Benzinschläuchen, Unterdruckleitungen, Druckluftschläuchen, LKW-Bremsleitungen etc. bis Ø 25mm.

**Nr. 839 001 Kunststoffrohrschneider**  
Code: OE350000035



**To cut plastic and nylon hoses.** Gasoline lines, vacuum-lines, air-hoses, brake lines etc. Ø up to 25mm.

**Nr. 839 001 PVC-hose cutter**  
Code: OE350000035

**Nr. 839 101** Ersatzmesser für Kunststoffrohrschneider  
Code: OE158001580  
Blade for PVC-hose cutter

## SPEZIAL-KLEMMGRIPZANGE SPECIAL LOCKING PLIER



**Spezial-Klemmgripzange zum Einschlagen der Verbindungsarmaturen** für Kunststoff- und Pneumatikleitungen bei Nutzfahrzeugen und Omnibussen. Mit dieser Zange können Verbindungen am Fahrzeug schnell und betriebssicher hergestellt werden.

**Nr. 839 210 Spezial-Klemmgripzange Typ 1**  
Code: OE126000126

**Nr. 839 220 Spezial-Klemmgripzange Typ 2**  
Code: OE126000126

**Nr. 839 230 Spezial-Klemmgripzange Typ 3**  
Code: OE126000126



**Special locking plier** for mounting the nipples into plastic hoses. Will be used for example at air brake systems of trucks. Ensures a quick and perfect job.

**Special locking plier type 1**

**Special locking plier type 2**

**Special locking plier type 3**



**Nr. 839 210 Typ 1 / Type 1**  
Ø 8, 9, 10, 11, 12mm e.g. MB

**Nr. 839 220 Typ 2 / Type 2**  
Ø 7, 9, 10, 12, 14mm e.g. MAN

**Nr. 839 230 Typ 3 / Type 3**  
Ø 15, 16, 18mm

## MONTAGEDORN MOUNTING PUNCH

Nr. 841 001  
Ø 20x300mm

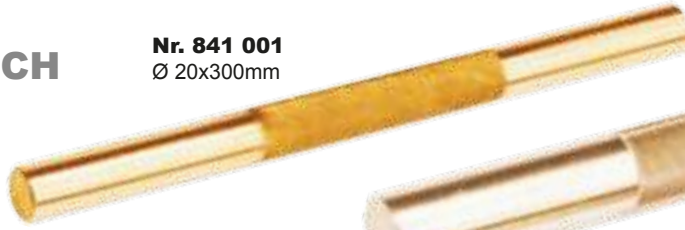

Nr. 841 030  
Ø 30x300mm



Für Lager, Bolzen, Buchsen etc.

**Nr. 841 001 Messingdorn 20x300mm**

Code: OE34000034

**Nr. 841 030 Alu-Dorn 30x300mm**

Code: OE29000029



For bearings, bolts, bushings etc.

**Brass mounting punch 20x300mm**

**Aluminium mounting punch 30x300mm**

## LKW-DURCHSCHLAG-SATZ HEAVY DUTY CONE PUNCH KIT



**300 x 6,4mm**

**Nr. 842 001**  
Code: OE23000023



**380 x 6,4mm**

**Nr. 842 002**  
Code: OE26000026



**300 x 8,0mm**

**Nr. 842 003**  
Code: OE28000028



**460 x 13,0mm**

**Nr. 842 004**  
Code: OE39000039



**Hochwertiger und massiver Durchschlag-Satz** für den täglichen universellen Werkstatteinsatz. Legierter US-Sonderstahl. 6-kant Schaft. Konisch zulaufende Spitze. Durchgehend gehärtet. Schlagkopf sorgfältig vergütet. Nachschleifbar.

**Nr. 842 005 LKW-Durchschlag-Satz 4-tlg.**

Code: OE116000116



**Heavy duty cone punch kit** for the daily workshop use. Alloyed US-steel. Hexagon shaft. Conical tip. Different heat treatment of tip and hammer side. Can be re-grounded.

**Heavy duty cone punch kit**

## FLACHMEIßEL-SATZ HEAVY DUTY CHISEL



**Hochwertige und massive Ausführung.** Legierter US-Sonderstahl. 6-kant Schaft. In zwei verschiedenen Längen erhältlich: 400 x 30mm, 600 x 30mm.

**Nr. 843 200 Flachmeißel-Satz, 2-tlg.**

Code: OE116000116



**Heavy duty tool.** Alloyed US-steel. Hex-shaft. 2 different lengths: 400 + 600mm

**Nr. 843 200 Heavy duty chisel kit, 2 pcs.**

Code: OE116000116

**Nr. 843 260**  
**600 x 30mm 6-kant**  
600 x 30mm hex-shaft

**2 verschiedene Längen: 400 + 600mm**  
2 different lengths: 400 + 600mm



**Nr. 843 240**  
**400 x 30mm 6-kant**  
400 x 30mm hex-shaft

1/2"



3/4"



**Drehmoment-Vervielfältiger** zum universellen Lösen und Anziehen von hochfesten Schraubenverbindungen. Das extrem hohe Antriebs-Drehmoment wird über ein Präzisions-Planetengetriebe erzeugt. Übersetzungsverhältnis 1:5 was z. B. bei 400Nm am 1/2" Innenantrieb eine Kraft von 2000 Nm am 3/4" Abtrieb (außen) erzeugt.

**Nr. 860 015 Kraft-Vervielfältiger 1:5**

Code: OE678000678

**KRAFTVERVIELFÄLTIGER 1:5**  
**TORQUE MULTIPLIER 1:5**



**Torque multiplier** for tightening and loosening of high torque screw connections. Output drive is made by high precision planetary gear. Gear ratio 1:5 which means 400 Nm at 1/2" input square (female) produce a torque of 2000 Nm at 3/4" output square drive (male).

**Torque-multiplier 1:5**

**UNIVERSAL ACHS- UND NUTMUTTERN-SCHLÜSSEL**  
**UNI AXLE NUT WRENCH**



**Inkl. Adapter-Pin zum Lösen von Nutmuttern**

Incl. adapter-pin for dismantling the slot nut



**Universal Achsmuttern-Schlüssel** zur Demontage und exakten Montage aller uns bekannten Achsmuttern (Sechskantmutter, Achtkantmutter, Nutmutter, Stirnlochmutter, Zweilochmutter, Kreuzlochmutter usw.) Drehmoment-Anzug (über 700Nm) möglich.

**Nr. 860 035 Universal Achsmuttern-Schlüssel**

Code: OE398000398



**Universal axle-nut wrench** for the safe and easy installing and mounting of axle nuts (hex, eight-point, slot nut...)

**Nr. 860 035 Uni axle nut wrench**

Code: OE398000398

**3/4" Antrieb**  
Drive: 3/4"

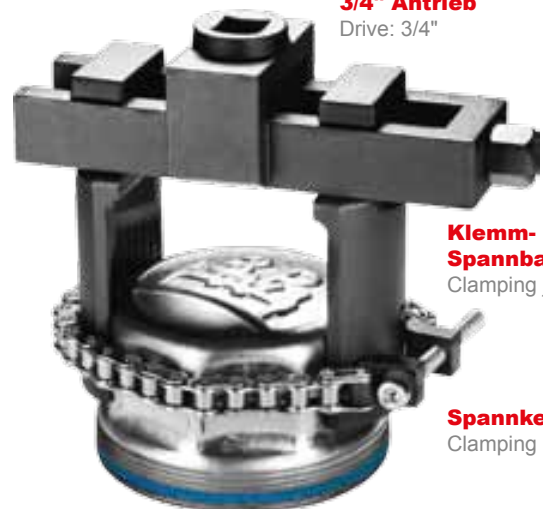

**Klemm- und Spannbacken**  
Clamping jaws

**Spannkette**  
Clamping chain

**70 - 150mm**  
**Spannbereich Sechskant**  
Clamping range hex

**80 - 170mm**  
**Spannbereich Nutmutter**  
Clamping range slot nuts



## LKW LAGERSCHALEN-MONTAGESATZ TRUCK BEARING RING MOUNTING KIT

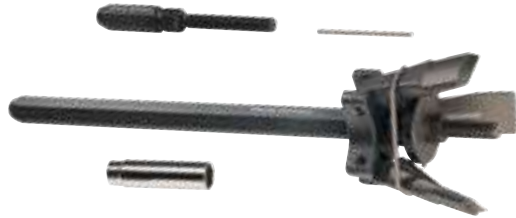

**Zur exakten und zentrischen De- und Montage** von LKW-Lagerschalen. Insbesondere zur verkantungsfreien Montage von Kegelrollenlagern in LKW-Radnaben. Auch zur Verwendung in der Werkstattpresse. Lieferung komplett im Koffer. Arbeitsbereich Ø 90 - 165 mm.

### Nr. 860 050 LKW Lagerschalen-Montagesatz

Code: OE278000278

Nr. 860 050/E Backensatz, 7-tlg.

Code: OE980000098



Nr. 860 050/E



**For precise and centric disassembly and assembly** of truck bearing races. Particularly for correctly aligned assembly of tapered roller bearings in truck wheel hubs. Can also be used in the workshop press. Supplied completely in a case. Ø 90 - 165 mm.

### Truck bearing ring mounting kit

7-part jaw set



**Auffangwanne** aus temperatur- und chemikalienbeständigem, bruchsicherem Kunststoff mit glatter und abriebfester Oberfläche. Für tiefergelegte Fahrzeuge geeignet. Inhalt: 28 Liter. Gewicht: 1,9 kg

### Nr. 902 390 Kühlwasser-Auffangwanne

Code: OE360000036



**Heat and chemical resistant oil drain pan.** The plastic pan is break proof. With smooth and indelible surface. Content: 28 liter. Weight: 1.9 kg.

### Nr. 902 390 Oil Drain Pan

Code: OE360000036

## KÜHLWASSER-AUFFANGWANNE OIL DRAIN PAN



## WERKSTATT-SERVICE-WAGEN GARAGE SERVICE CART



**Werkstatt-Service-Wagen mit hoher Ablagefach-Last.** Stabile, kugelgelagerte und dreh- und blockierbare Leichtlaufrollen.

### Nr. EQ-370 Werkstatt-Service-Wagen

Code: OE178000178



**Garage Service Cart with high load capacity.** Turn- and lockable casters with ball bearings.

### Nr. EQ-370 Garage Service Cart

Code: OE178000178

TOP  
max. 135kg

max. 45kg

max. 45kg



## ACHSÖLWANNE LKW AXLE OIL DRAIN PAN



Zur sauberen Arbeit an der Achse.  
Inhalt 2,5 Liter. Passend für fast alle Felgen.

**Nr. 902 382 Achsölwanne Satz, 2-tlg.**

Code: OE48000048



Ensures a professional and clean workspace. Content: 2.5 liter. Fits for nearly all rim diameters

**Axle Oil Drain Pan Kit, 2-pcs.**



## ARBEITS-SCHUTZKISSEN WORK PROTECTION MAT



**Professionelles Gesamterscheinungsbild der Werkstatt.** Keine Verwendung von Putzklappen, Kartons etc. Wasserabweisend. Wärmespeichernd durch spezielles 3-lagiges Softmaterial. Gesundheitsvorsorge. Benzin- und ölfest, auch als Sitzauflage geeignet.

**Nr. 905 000/3 Knie-Schutzkissen Pack, 3 Stk.**

Code: OE540000054

**Nr. 905 000/10 Knie-Schutzkissen Pack, 10 Stk.**

Code: OE178000178

**Nr. 905 001 Arbeits-Schutzmatte**

Code: OE580000058

**Nr. 905 001/2 Arbeits-Schutzmatte, 2 Stk.**

Code: OE108000108



**Professional workshop equipment.** No use of old cartons etc. Water resistant. Health protection through 3-layer soft material. Oil and gasoline resistant. Can be used as well for seat protection.

**Knee protection-pad, 3 pcs.**

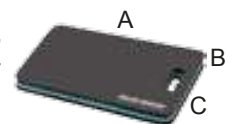

A x B x C mm

480 x 36 x 320mm

**Knee protection-pad, 10 pcs.**

480 x 36 x 320mm

**Work protection mat**

1150 x 36 x 550mm

**Work protection mat, 2 pcs.**

1150 x 36 x 550mm



# EQUIPMENT



**MÜLLER Tipp:**  
elektronisches Dokument  
Artikelsuche mit "Strg + F"

**MUELLER Tip:**  
electronic document  
Product Search "Ctrl + F"

**Apple:** "⌘ + F"

## HYDRAULIK-SET 20 TO. HYDRAULIC-SET 20 TO.



**20 to. Hydraulik-Set.** Extrem hoher und gleichmäßiger Kraftaufbau. Zylinderbohrung ermöglicht sowohl Druckkraft als auch Zugkraft in Verbindung mit entsprechender Spindel. 700 bar Hydraulik.

**Nr. EQ-320** Hydraulik-Set 20 to.  
Code: OE99800998



**High pull or push force of 20 ton.** will be generated evenly. Hollow piston construction. 700 bar hydraulic system.

**Nr. EQ-320** Hydraulic-set 20 to.  
Code: OE99800998

**20 to. Hydraulik  
Hohlkolbenzylinder**  
20 to. Hydraulic  
hollow piston

**700 bar Handpumpe**  
700 bar hydraulic pump

**Zugspindel  
M20x500mm mit  
Muttern und  
Kugelscheiben**

Spindle M20x500mm with  
nuts and rounded washer



## DRUCK- UND ZUGHÜLENSATZ + HYDRAULIK-SET 20 TO. PRESS AND PULL SLEEVE KIT + HYDRAULIC-SET 20 TO.



**Universal Werkzeugsatz** zum Aus- und Einziehen von: Silentlagern, Hydrolagern, Buchsen, Kugellagern, Simmerringen, Gummilagern etc. Absolut universelle Anwendung. Ideal für unterschiedliche Fahrzeuge, Transporter und LKW. 20 to.

**Hydraulik-Set.** Extrem hoher und gleichmäßiger Kraftaufbau. Zylinderbohrung ermöglicht sowohl Druckkraft als auch Zugkraft in Verbindung mit entsprechender Spindel. 700 bar Hydraulik.

**Nr. EQ-320/420** Druck- und Zughülzensatz  
Code: OE198001980 + Hydraulik-Set 20 to.



**Universal tool set** for extracting and drawing in: silent bearings, hydraulic bearings, bearing bushes, ball bearings, shaft seals, rubber bearings etc. Fully universal application. Ideal for different vehicles.

**High pull or push force of 20 ton.** will be generated evenly. Hollow piston construction. 700 bar hydraulic system.

**Nr. EQ-320/420** Press & Pull Sleeve Kit  
Code: OE198001980 + Hydraulic-set 20 to.





## HYDRAULIK-SET 20 TO. HYDRAULIC-SET 20 TO.

### Hochfeste Spindel, M20x500mm mit Muttern und Kugelscheiben

Spindle M20x500mm with  
nuts and rounded washer



**Hochdruckschlauch,  
700bar, 2m**  
Hose, 700bar, 2m

**Schnellverbindungs-  
Kupplung**  
Quick-chuck

### Pneumatik-Hydraulik-Einheit, Fußbetätigung, 700bar

Pneumatic-hydraulic-unit, foot control,  
700 bar

Nr. EQ-700

**Zylinder-Hub: 52mm**  
Cylinder-hub: 52mm



**20 to. Hydraulik-Set, ideales Kombinationswerk-  
zeug** für Druck- und Zughülzensatz Typ I+II. Hydraulik-  
Hohlkolben-Zylinder. Hoher und gleichmäßiger Kraftaufbau.  
Zylinderbohrung ermöglicht sowohl Druckkraft als auch Zug-  
kraft in Verbindung mit entsprechender Spindel.  
Optional: Spindel in verschiedenen Längen lieferbar.

**Nr. EQ-320/700 Hydraulik-Set pneumatisch 20 to.**  
Code: OE117601176  
Lieferung komplett in Box.



**20 to. Hydraulic-set. Perfect combination-tool** for  
press and pull sleeve kit type I+II. High pull or push of 20 to.  
will be generated evenly. Hollow piston construction. 700 bar  
foot pump.

**Hydraulic-set with pneumatic pump 20 to.**

## HYDRAULIK-ANTRIEB HYDRAULIC-OPERATION



Nr. 300 015



Nr. EQ-300 014

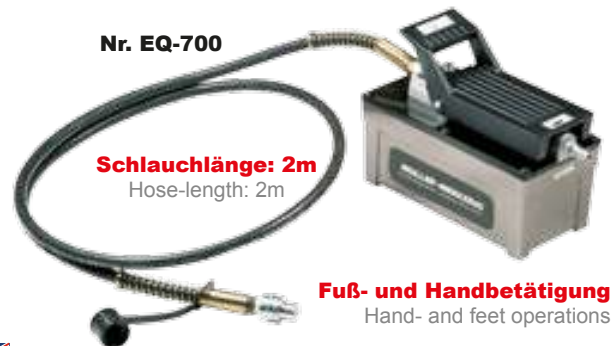

Nr. EQ-700

**Schlauchlänge: 2m**  
Hose-length: 2m

**Fuß- und Handbetätigung**  
Hand- and feet operations



**Nr. EQ-700**  
Code: OE438000438

**Pneumatik / Hydraulik-Einheit  
700 bar**

**Nr. EQ-300 014 Hydraulik-Handpumpe 700 bar**  
Code: OE388000388

**Pneumatic-hydraulic unit 700 bar**

**Nr. 300 015**  
Code: OE128000128

**Hydraulik-Schlauch 700 bar, 2m**

**Hydraulic pump 700 bar**

**Hydraulic hose 700 bar, 2m**

## HYDRAULIK HOHLKOLBEN-ZYLINDER HOLLOW PISTON HYDRAULIC-CYLINDER



**Nr. 300 120**  
**20 to. Hohlkolben-Zylinder Ø 26,0mm**  
20 to. hollow piston cylinder Ø 26,0mm



**Nr. 300 013**  
**12 to. Hohlkolben-Zylinder Ø 19,0mm**  
12 to. hollow piston cylinder Ø 19,0mm



**Nr. 300 015**  
**700 bar Hydraulik-Schlauch, 2m**  
700 bar hydraulic-hose, 2m



**Nr. 300 011**  
**Zugspindel M16x500mm mit Muttern und Kugelscheiben**  
Spindle M16x500mm with nuts and rounded washer



**Nr. 300 017**  
**Zugspindel M20x500mm mit Muttern und Kugelscheiben**  
Spindle M20x500mm with nuts and rounded washer



**Hydraulik-Hohlkolben-Zylinder in 12 und 20 to.** Ausführung erhältlich. Extrem hoher und gleichmäßiger Kraftaufbau. Zylinderbohrung ermöglicht sowohl Druckkraft als auch Zugkraft in Verbindung mit entsprechender Spindel.  
(12 to. Zylinder/ M16 Spindel, 20 to. Zylinder/ M20 Spindel)

**Nr. 300 013** **Hydraulik-Hohlkolbenzylinder 12 to.**

Code: OE588000588

**Nr. 300 120** **Hydraulik-Hohlkolbenzylinder 20 to.**

Code: OE980000980

**Nr. 300 120/ALU** **Alu-Hydraulik-Hohlkolbenzylinder 20 to.** extrem geringes Gewicht: 4,30Kg

Code: OE980000980

**Nr. 300 011** **Zugspindel für Hydraulik M16 x 500mm**

Code: OE900000090

**Nr. 300 017** **Zugspindel für Hydraulik M20 x 500mm**

Code: OE900000090

**Nr. 300 015** **Hydraulik-Schlauch 700 bar, 2m**

Code: OE128000128



**Hollow piston hydraulic cylinder designed in 12 to. or 20 to.** High pull or push force of 12 to. or 20 to. will be generated evenly. Hollow piston construction. (12 to. cylinder / M16 spindle, 20 to. cylinder / M20 spindle)

**Hollow piston 12 to.**

**Hollow piston 20 to.**

**Aluminium Hollow piston 20 to.** light weight: 4.30Kg

**Spindle for hydraulics M16 x 500mm**

**Spindle for hydraulics M20 x 500mm**

**Hydraulic hose 700 bar, 2m**

## WERKSTATT-SERVICE-WAGEN GARAGE SERVICE CART



**Werkstatt-Service-Wagen mit hoher Ablagefach-Last.** Stabile, kugelgelagerte und dreh- und blockierbare Leichtlaufrollen.

**Nr. EQ-370 Werkstatt-Service-Wagen**

Code: OE178000178



**Garage Service Cart with high load capacity.** Turn- and lockable casters with ball bearings.

**Nr. EQ-370 Garage Service Cart**

Code: OE178000178

**TOP**  
**max. 135kg**

**max. 45kg**

**max. 45kg**



## DRUCK- UND ZUGHÜSENSATZ IM WERKSTATT-SERVICE WAGEN PRESS AND PULL SLEEVE KIT IN GARAGE SERVICE CART



**Werkstatt-Service Wagen mit Ablagefläche**

Middle and bottom shelf to store parts

**Übersichtliche Anordnung**

Ideal storage



**Universal Werkzeugsatz** zum Aus- und Einziehen von: Silentlagern, Hydrolagern, Buchsen, Kugellagern, Simmeringen, Gummilagern etc. Absolut universelle Anwendung. Ideal für unterschiedliche KFZ.

**Werkstatt-Service Wagen mit hoher Ablagefach-Last.** Oberes Ablagefach bis max. 135 Kg belastbar. Mittleres und unteres Ablagefach bis max. 45 Kg belastbar. Stabile, kugelgelagerte und drehbare Leichtlauf-Rollen.

**Schaumstoffeinlage** zur idealen Aufbewahrung des Druck- und ZughüSENSATZES. Alle HüSEN übersichtlich angeordnet und schnell griffbereit. Schaumstoffeinlage passend für alle 3 Ablagefächer des Werkstatt-Service Wagen.

**Nr. EQ-371**  
Code: OE69800698

**Druck- und ZughüSENSATZ im Werkstatt-Service Wagen**



**Universal tool set** for extracting and mounting: silent bearings, hydraulic bearings, bearing bushes, ball bearings, shaft seals, rubber bearings etc. Fully universal application. Ideal for different vehicles.

**Garage service cart with high load capacity.** Top shelf max. 135 Kg. Middle and bottom shelf max. 45 Kg. Turnable casters with ball bearings.

**Inlay for press and pull sleeve kit** for the ideal storage. All sleeves are clearly arranged and easy to find. Inlay fits for all three shelves of garage service cart.

**Press and pull sleeve kit in Garage service cart**

**WERKZEUGWAGEN**  
**TOOLBOX**



**173mm tiefes Top-Fach**  
 173mm top-case



**Kugelgelagerte Rollen mit Gummilauffläche**  
 High Quality Casters with rubber coating and ball bearings



**Werkzeugwagen** mit folgenden Maßen: Länge: 886mm, Breite: 537mm, Höhe: 954mm. 5-Schubladen, 100% Schubladenauszug, großes Top-Fach mit Stoßdämpfern, abschließbar, massiver Ziehgriff, kugelgelagerte Rollen mit Gummilauffläche.

**Nr. EQ-376 Werkzeugwagen**

Code: OE59800598



**Toolbox** measure: length: 886mm, width: 537mm, height: 954mm. 5 push loading drawer, 100% sliding drawer shelf, lockable, high quality steel casters with rubber coating and ball bearings.

**Nr. EQ-376 Toolbox**

Code: OE59800598

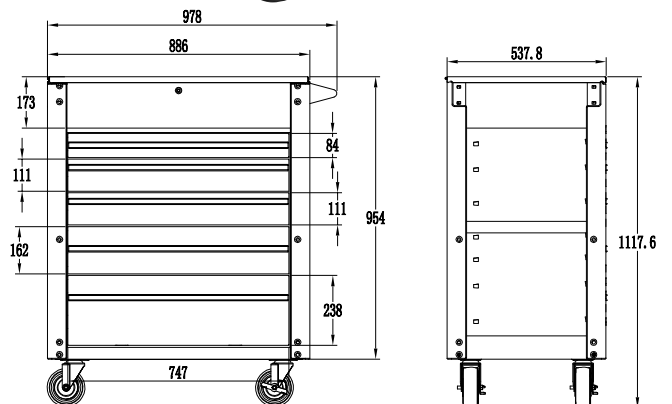

# TELESKOP-GETRIEBEBEHEBER 500 KG

## TELESCOPIC TRANSMISSION JACK 500 KG



**Schnelles Heben und Senken.** Teleskop mit max. Höhe von 180cm. Massive Stahlrollen mit Gummi-Laufflächen, kugelgelagert. Sicherer Halt durch extra großen Radabstand. Fußbedienung.

**Nr. EQ-500T**  
Code: OE998000998

**Teleskop-Getriebeheber 500kg**  
mit Uni-2-Achs-Schwenkplatte

**Nr. EQ-500T-A**  
Code: OE980000998

**Adapter für VAG-Motoren-**  
**aufnahme**  
wird auf der Schwenkplatte verschraubt

**Nr. EQ-500T/H-0**  
Code: OE750000750

**Teleskop-Getriebeheber 500kg**  
**ohne** Uni-Schwenkplatte, Durchmesser  
Kolben oben 30mm

**Nr. EQ-500T/G**  
Code: OE248000248

**Uni-2-Achs Schwenkplatte**  
Aufnahmebohrung 30mm



Spindles of the swivel head include ball bearings. Repair jobs of engines and transmissions can be done directly on the jack.

**Nr. EQ-500T**  
Code: OE998000998

**Telescopic transmission jack**  
**500 kg**  
with 2-axis swivel head

**Nr. EQ-500T-A**  
Code: OE980000998

**Adapter for VAG-engines**  
bolt connected to swivel plate

**Nr. EQ-500T/H-0**  
Code: OE750000750

**Telescopic transmission jack**  
**500 kg**  
**no** swivel head, ram diameter 30mm

**Nr. EQ-500T/G**  
Code: OE248000248

**Uni-2-axis swivel head**  
bore diameter 30mm

**Verschiedene Adapterstücke**  
**auf Anfrage separat lieferbar.**

Additional adapters available on special request.

**Schwenkplatte mit**  
**kugelgelagerten**  
**Verstellspindeln**  
**ermöglicht**  
**eine direkte**  
**Reparatur auf dem**  
**Teleskopheber.**  
**24° schwenkbar**  
**nach 4 Seiten.**

Spindles of the swivel head include ball bearings for the direct-on repairing on the transmission jack

**max: 180cm**  
**min: 87cm**

**Fußbedienung**  
Foot control



**Stahlrollen mit Gummi-Lauffläche, kugelgelagert**  
Steel casters with rubber coating and ball bearings

## DREHMO-TESTER FÜR DIE KFZ-WERKSTATT WORKSHOP TORQUE WRENCH TESTER

**Drehmomentschlüssel testen  
und Prüfzertifikat selbst erstellen**



**Nr. 531 010**  
Code: OE128000128

**1/2" Drehmomentschlüssel,  
20-200Nm**  
1/2" Torque wrench, 20-200Nm

**Adapter für 1/4", 3/8", 1/2" Antrieb  
(Im Lieferumfang enthalten)**



**Elektronisches Testgerät** zur vorgeschriebenen **ISO-Prüfung** der Drehmoment-Schlüssel. Für Rechts- und Linksanzug. Messbereich 5 - 500Nm. 4-kant Adapter für 1/4", 3/8", 1/2". Integrierter Torsions-Messwertgeber garantiert hohe Messgenauigkeit, unter 1 % Toleranz des Ablesewertes. Großes LCD-Display zur optimalen Erkennung der digitalen Nm-Skala. Netzunabhängige Anwendung möglich. **Zertifiziert nach DIN EN ISO 6789.**

Mit diesem Tester können Drehmomentschlüssel von der Werkstatt selbst geprüft und Prüf-Zertifikate erstellt werden.

**Nr. EQ-531 Drehmo-Tester für die  
Code: OE398000398 KFZ-Werkstatt**



**Electronic testing instrument** for the required **ISO check** of torque wrenches. Fits for left and right torque wrenches. Torque range 5-500Nm. Square adapter for 1/4", 3/8" + 1/2" drives. 1% accuracy based on the integrated torsion sensor. Large LCD display avoids reading errors of the exactly Nm. Battery powered. No AC power needed. **Certificated on German DIN EN ISO 6789 standard. Workshops can create test certificates** by themselves with workshop torque tester. Saves money. No external companies needed.

**Workshop torque wrench tester**

## UNI-SCHNELLSTART- UND LADEGERÄT UNI POWER PACK AND BOOSTER



**Starthilfe** für PKW, Motorräder, Rasentraktoren, Boote etc. **Ladegerät und Stromversorgung** für Laptops, Handys, Tablets etc. Eingebaute Absicherung für Überladung, Entladung, Thermosicherung, Verpolschutz, Kurzschluss-Schutz. Beleuchtetes LCD Display, LED Lampe, automatische Abschaltung. Arbeitstemperatur 0°C - 60°C, Arbeitstemperatur mit Niedrig-Temperatur-Adapter -20°C - 60°C. Lieferumfang enthält: Starthilfekabel, Universal-Sortiment für verschiedene Geräte, Tasche.

**Nr. EQ-727 050 UNI-Schnellstart- und Ladegerät  
Code: OE198000198**



**Jump start** for cars, light trucks, motorcycles, ATVs, snowmobiles and watercraft. **Charges and powers:** laptops, cell phones, tablets and more. Built-in protection for over-charge, over-discharge, over-temperature, reverse current, reverse polarity, and short circuit protection.

**Nr. EQ-727 050 UNI Power Pack and Booster  
Code: OE198000198**



<b>MÜLLER-WERKZEUG</b> Technische Daten / technical information	
<b>Batterietyp /</b> <b>Battery Type</b>	12000 mAh (36 Wh) Lithium-Ionen-Phosphat-Batterie 12000mAh (36Wh) Lithium Ion Phosphate Battery
<b>Ladegerät /</b> <b>Charger</b>	15 V / 1,0 A WS/GS Adapter 15V/1.0A AC/DC Adapter
<b>Ausgänge (mit 120 W Überlastschutz) /</b> <b>DC Outlets (with 120W overload protection)</b>	19 V / 3,5 A - 12 V / 8 A
<b>USB / USB</b>	5 V / 2,1 A
<b>Ampere Spitze / Peak Amps</b>	600 A
<b>Startleistung / Cranking Amps</b>	300 A
<b>Hochleistungs-LED / High Power LED</b>	1 W
<b>Abmessungen des Starthilfegeräts /</b> <b>Dimension of Jump Starter</b>	(L x B x H) 18 x 10 x 4 cm (L x W x H) 7-1/2" x 3-15/16" x 1-9/16"
<b>Gewicht / Weight</b>	750 g / 1.65 lb

## INDUKTIONSERHITZER INDUCTION-HEATER



Keine Verwendung von Schweißbrenner etc.

**Punktgenaue Erhitzung des Bauteiles** durch das Induktionsprinzip.

Enwickelt für 220 Volt Stromnetz.

**Made in Europe.**

Erhitzung des Bauteils bis zu **kirschrot 780°C**.

Inklusive 4 Heizspiralen: 19mm, 23mm, flexibel, Pad.

1.500 Watt, 7A, Gewicht: 1,8 Kg.

**Anwendung universal** z. B.:

- **Festgebrannte, festgefressene, verrostete Bauteile**
- Lenkung und Aufhängung
- Auspuffsystem
- Lambdasonden etc.
- Zum **"Aufsprengen"** von "unlösbaren" **Klebeverbindungen** (Chem. mikroverkapselte Schraubverbindungen)

**Nr. EQ-230 Induktionserhitzer**

Code: OE538000538



- New high output electro-magnetic induction heater.
- European made to achieve highest outputs using 220V supplies.
- Faster heating and longer cycle times than competitor machines.
- Kit includes 4 coils (19mm, 22mm, flexible, pad).
- Kit comes into storage case.

**Perfect for:**

- Seized components, Steering and Suspension.
- Exhaust Systems.
- Oxygen sensor.
- Bodyshop use (Use with Heat Pad).
- 1.500 watt average output. 7A.

**Induction-Heater**

## UNIVERSAL GRUBENBRÜCKE, BODENEBCN FLAT TYPE PIT BRIDGE



<b>MÜLLER-WERKZEUG</b> Technische Daten / technical information		
verstellbare Breite / width	mm	870 - 1150
Traglast / loading capacity	Kg	400
Gewicht / weight	Kg	ca. 45

### FLAT TYPE PIT BRIDGE



**Sicherheits-Grubenbrücke passend für Gruben ohne Schienenführung.**  
 Optionale Sicherheitsbügel. Rutschfestes Gitterrost. Alle Teile kunststoffbeschichtet in Signalfarbe. Gefordert nach den Sicherheitsregeln der deutschen Berufsgenossenschaft BGR 157, 5.6 (5.6.5).  
 Made in Germany.

**Nr. EQ-510 050/BE Universal Grubenbrücke, bodeneben, inkl. Sicherheitsgeländer**  
 Code: OE678000678

**Nr. EQ-510 050/BEG Universal Grubenbrücke, bodeneben, ohne Sicherheitsgeländer**  
 Code: OE498000498



**Due to its adjustable width, the safety pitbridge fits for nearly all pit distances.**  
 Optional safety rails. Made in Germany.

**Truck pit bridge with handrail, flat type**

**Truck pit bridge no handrail, flat type**

## SICHERHEITSGELÄNDER FÜR UNIVERSAL GRUBENBRÜCKE HANDRAIL FOR PIT BRIDGE



**Nr. EQ-510 050/S**  
 Code: OE198000198  
**Sicherheitsgeländer-Satz, 2-tlg.**



**Nr. EQ-510 050/S**  
 Code: OE198000198  
**Handrail, 2 pcs.**

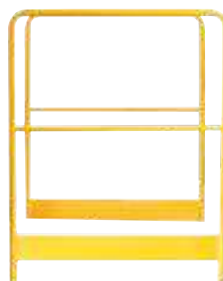



## UNIVERSAL GRUBENBRÜCKE RAIL TYPE PIT BRIDGE



<b>MÜLLER-WERKZEUG</b> Technische Daten / technical information		
verstellbare Breite / width	mm	870 - 1150
Traglast / loading capacity	Kg	400
Gewicht / weight	Kg	ca. 45



## RAIL TYPE PIT BRIDGE



**Sicherheits-Grubenbrücke passend für Gruben mit Schienenführung.** Optionale Sicherheitsbügel. Rutschfestes Gitterrost. Alle Teile kunststoffbeschichtet in Signalfarbe. Gefordert nach den Sicherheitsregeln der deutschen Berufsgenossenschaft BGR 157, 5.6 (5.6.5). Made in Germany.

**Nr. EQ-510 050 Universal Grubenbrücke inkl. Sicherheitsgeländer**  
Code: OE678000678

**Nr. EQ-510 050/G Universal Grubenbrücke ohne Sicherheitsgeländer**  
Code: OE498000498



**Due to its adjustable width,** the safety pitbridge fits for nearly all pit distances. Optional safety rails. Made in Germany.

**Truck pit bridge rail type, with handrail**

**Truck pit bridge rail type, no handrail**

## SICHERHEITSGELÄNDER FÜR UNIVERSAL GRUBENBRÜCKE HANDRAIL FOR PIT BRIDGE



**Nr. EQ-510 050/S**  
Code: OE198000198  
**Sicherheitsgeländer-Satz, 2-tlg.**



**Nr. EQ-510 050/S**  
Code: OE198000198  
**Handrail, 2 pcs.**

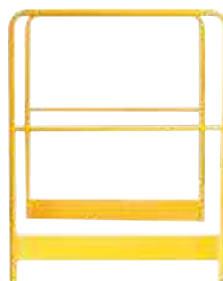

## UNIVERSAL LECKAGE-SUCHER LS07 LEAKAGE DIAGNOSTIC UNIT LS07



**Zur schnellen Diagnose von Leckagen** vor dem Einsatz des Diagnosegerätes. Im Gerät wird ein sehr dichter Testrauch erzeugt. Dieser Testrauch wird mit leichtem Überdruck in ein geschlossenes System eingebracht. Eventuelle Öffnungen des zu prüfenden Systems sind durch die enthaltenen Stopfen abzudichten. Der Testrauch tritt an eventuellen Leckagen sichtbar aus.

**Nr. EQ-727 100 Universal Leakage-Sucher LS07**

Code: OE79800798



**For the quick diagnostic of leaks** instead of the workshop diagnostic equipment. This unit generates a dense test-smoke. This test-smoke will be filled into closed systems with a light pressure. Close all openings of the system with the enclosed gland seals. The test-smoke will be visible at the leak.

**Nr. EQ-727 100 Leakage diagnostic unit LS07**

Code: OE79800798



## RADHEBER WHEEL LIFTER



Einfache und sichere Demontage und Montage von Kompletträdern bis 50 kg bei PKW und Transportern. Mechanische Ausführung, Betätigung mit Schlag- oder Akkuschauber.

**Nr. EQ-1251 Radheber**

Code: OE62800628



Easy handling of wheels up to 50 kg. Unit is driven by impact gun or cordless gun.

**Nr. EQ-1251 Wheel lifter**

Code: OE62800628

### MÜLLER-WERKZEUG

#### Technische Daten / technical information

Max / capacity	kg	50
Arbeitshöhe / lift range	m	1,08
Gewicht / weight	kg	51

# INDEX

101 100	Ersatz-Trennscheiben Ø 100mm, 10 Stk. Replacement Cutting discs Ø 100mm, 10 pcs.	1-23 5-04 6-31	111 550/K40	Mini Lamellenscheiben Ø 50mm, 10er Pack, Körnung K40 Mini flap disc Ø 50mm, 10pack, grid K40	5-05 6-02 8-04	244 106	Bohrer HSSE TIN 6,0 x 70mm Drill HSSE TIN 6,0 x 70mm	5-08
106 500	Hartmetallfräser-Satz Carbide Cutter Kit	1-22 1-26 5-06 6-30	111 550/K60	Mini Lamellenscheiben Ø 50mm, 10er Pack, Körnung K60 Mini flap disc Ø 50mm, 10pack, grid K60	1-04 1-20 2-04 5-05 6-02 8-04	244 108	Bohrer HSSE TIN 8,0 x 80mm Drill HSSE TIN 8,0 x 80mm	5-08
110 400	Trennscheibensortiment, 9tlg. Cut off disc kit, 9pcs.	1-21 5-05 6-29	111 550/K80	Mini Lamellenscheiben Ø 50mm, 10er Pack, Körnung K80 Mini flap disc Ø 50mm, 10pack, grid K80	1-04 1-20 2-04 5-05 6-02 8-04	244 110	Bohrer HSSE TIN 10,0 x 90mm Drill HSSE TIN 10,0 x 90mm	5-08
110 458	Ersatz-Trennscheiben Ø 50mm x 0,8, 10 Stk. Replacement Cutting discs Ø 50mm x 0,8, 10 pcs.	1-20				244 210	Bohrer HSSE TICN 10,0 x 90mm Drill HSSE TICN 10,0 x 90mm	5-08
111 002	Spanndorn für Reinigungsscheibe Adapter for cleaning disc	5-04				244 805	Punktschweißbohrer Satz, 5-tlg. 5-pack Spot Welding Drill Bits	5-05
111 022/PUR	Reinigungsscheiben-Satz, 22-tlg. Cleaning discs kit, 22 pcs.	5-02				244 806	Bohrer HSSE TICN 6,0 x 70mm Drill HSSE TICN 6,0 x 70mm	5-08
111 023	Reinigungsscheiben-Satz, 18-tlg. Cleaning discs kit, 18 pcs.	5-02	111 812	Universal Reinigungsset für Kontaktflächen, 16-tlg. Air Angle Grinder Kit, 16 pcs.	1-04 2-04 6-02 8-04	244 808	Bohrer HSSE TICN 8,0 x 80mm Drill HSSE TICN 8,0 x 80mm	5-08
111 024	Reinigungsscheiben-Satz, 19-tlg. Cleaning discs kit, 19 pcs.	5-02				245 100	Ahlensatz Typ I + II, 4-tlg. Reamer kit I + II, 4 pcs.	5-13
111 031	Reinigungsscheiben-Sortimentsbox Typ 1 Workshop box for cleaning discs type 1	5-03	212 420	Tigersägeblatt 180mm, Spezialzahnung, 10 Stk. Saw-blades 180mm, 10 pcs.	5-12	245 101	Ahlensatz Typ I für Original Einparkhilfe VAG, 2-tlg. Reamer kit I, original parking sensor VAG, 2 pcs.	5-13
111 050	Reinigungsscheiben, max. 10.000 U/min, Ø50 x 13mm Cleaning disc, max. rpm 10.000, Ø50 x 13mm	5-04	212 454	Tigersägeblatt 130mm, Spezialzahnung, 10 Stk. Saw-blades 130mm, 10 pcs.	5-12	245 102	Ahlensatz Typ II für ETKA Nachrüstsatz, 2-tlg. Reamer kit II, for parking sensor ETKA, 2 pcs.	5-13
111 050/PUR	Reinigungsscheiben, max. 10.000 U/min, Ø50 x 13mm Cleaning disc, max. rpm 10.000, Ø50 x 13mm	5-04	212 456	Hartmetall Sägeblatt für hochfeste Stähle/Bleche Carbide saw blade 2 pcs.	5-12	250 050	Handschlagschrauber Set, 3/8" Brake-screw impact kit, 3/8"	3-02
111 052	1x Aufnahmeschaft für Roloc Ø50mm 1x Adapter for Roloc Ø50mm	1-20	222 000	Doppel-Hartmetall-Punktschweißbohrer 8,0mm, 2-tlg. Double Carbide Spot Weld Drill 8,0mm, 2pcs.	5-06	262 001	Karosserie-Spannhalter Body work file holder	6-05
111 052	Aufnahmeschaft mit Gewinde für Reinigungsscheibe 50mm Holder shank with thread for cleaning disc 50mm	5-04	222 008	Doppel-Punktschweißbohrer HSSE 8,0mm Twin end drill HSSE 8,0mm	5-07	263 001	Feilenblatt radial gefräst, mittelfein File blades radial cut, medium fine	6-05
111 075	Reinigungsscheiben, max. 10.000 U/min, Ø75 x 13mm Cleaning disc, max. rpm 10.000, Ø75 x 13mm	5-04	222 008/3	Doppel-Punktschweißbohrer Satz 3-tlg. Twin end drill HSSE 8,0mm, 3 pcs.	5-07	263 002	Feilenblatt radial gefräst, grob File blades radial cut, coarse	6-05
111 075/PUR	Reinigungsscheiben, max. 10.000 U/min, Ø75 x 13mm Cleaning disc, max. rpm 10.000, Ø75 x 13mm	5-04	222 050	Hartmetall-Punktschweißbohrer 3-schneidig, 8,0x50mm, 2-tlg. Carbide Spot Weld Drill 3-edged 8,0x50mm, 2pcs.	5-06	263 003	Feilenblatt schräg gefräst, mittelfein File blades diagonal cut, medium fine	6-05
111 076	Aufnahmeschaft mit Gewinde für Reinigungsscheibe 75mm Holder shank with thread for cleaning disc 75mm	5-04	222 300	Punktschweißfräser 8,0x44mm VARIO-DRILL, 2-tlg. Spot weld drill VARIO-DRILL 8,0x44mm, 2pcs.	5-07	263 004	Feilenblatt schräg gefräst, grob File blades diagonal cut, coarse	6-05
111 100	Reinigungsscheiben, 13mm Bohrung, max. 6.000 U/min, Ø100 x 13mm Cleaning disc, bore hole 13mm, max rpm 6.000, Ø100 x 13mm	5-04	222 308	Punktschweißfräser 8,0 x 44 mm Carbide spot weld drill bit 8,0 x 44 mm	1-03 5-09 6-04	266 050	Kunststoff-Nietsatz Plastic pop riveter	6-06
111 100/PUR	Reinigungsscheiben, 13mm Bohrung, max. 6.000 U/min, Ø100 x 13mm Cleaning disc, bore hole 13mm, max rpm 6.000, Ø100 x 13mm	5-04	222 600	Punktschweißfräser 8,0 x 45mm SPITZNAGEL, 2-tlg. Spot weld drill SPITZNAGEL 8,0x45mm, 2pcs.	5-07	267 002	Montagekeil Trim clip tool	6-06
111 150	Reinigungsscheiben, 13mm Bohrung, max. 6.000 U/min, Ø150 x 13mm Cleaning disc, bore hole 13mm, max rpm 6.000, Ø150 x 13mm	5-04	222 700	Punktschweißfräser 8,0 x 39mm SPOTLE-DRILL, 2-tlg. Spot weld drill SPOTLE-DRILL 8,0x39mm, 2pcs.	5-07	267 400	Fensterleisten Heber Window moulding remover	6-07
111 150/PUR	Reinigungsscheiben, 13mm Bohrung, max. 6.000 U/min, Ø150 x 13mm Cleaning disc, bore hole 13mm, max rpm 6.000, Ø150 x 13mm	5-04	235 002	Sägeblätter Z-24 Saw-blades Z-24	1-05 5-13 6-03	267 500	Verkleidungsloser Heckklappe Finish panel detachment	6-07
111 151	Reinigungsscheibe für Winkelschleifer, max. 6.000 U/min, Ø115 x 22 x 13mm Cleaning disc for angle grinder, max rpm 6.000, Ø115 x 22 x 13mm	5-04	235 003	Sägeblätter Z-32 Saw-blades Z-32	1-05 5-13 6-03	268 220	Hartmetall Schaber Satz Carbide Scraper kit	3-03 6-08
111 151/PUR	Reinigungsscheibe für Winkelschleifer, max. 6.000 U/min, Ø115 x 22 x 13mm Cleaning disc for angle grinder, max rpm 6.000, Ø115 x 22 x 13mm	5-04	235 004	Sägeblätter Z-14 Saw-blades Z-14	1-05 5-13 6-03	268 320	XL Hartmetall Schaber Satz XL Carbide Scraper kit	6-08
111 250	Reinigungsscheiben, 6mm Schaft, max. 10.000 U/min, Ø50 x 13mm Cleaning disc with 6mm shank, max rpm 10.000, Ø50 x 13mm	5-04	235 005	Sägeblätter Z-18 Saw-blades Z-18	1-05 5-13 6-03	268 400	Schabmeißel-Satz, 4-tlg. Chisel scraper kit, 4 pcs.	3-03 6-09
111 250/PUR	Reinigungsscheiben, 6mm Schaft, max. 10.000 U/min, Ø50 x 13mm Cleaning disc with 6mm shank, max rpm 10.000, Ø50 x 13mm	5-04	235 010	Sägeblätter Z-32 Saw-blades Z-32	1-05 5-13 6-03	268 405	Schabmeißel, gebogen Chisel scraper, bended	6-09
111 275	Reinigungsscheiben, 6mm Schaft, max. 10.000 U/min, Ø75 x 13mm Cleaning disc with 6mm shank, max rpm 10.000, Ø75 x 13mm"	5-04	235 011	Sägeblätter Z-24 Saw-blades Z-24	1-05 5-13 6-03	268 420	Klingen-Schaber Razor Scraper	6-10
111 275/PUR	Reinigungsscheiben, 6mm Schaft, max. 10.000 U/min, Ø75 x 13mm Cleaning disc with 6mm shank, max rpm 10.000, Ø75 x 13mm	5-04	235 014	Sägeblätter Z-14 Saw-blades Z-14	1-05 5-13 6-03	268 421/10	Ersatzklingen Kunststoff, 10 Pack à 10 Stück Spare blades plastic, 10 pack à 10 pieces	6-10
111 550/K40	Mini Lamellenscheiben Ø 50mm, 10er Pack, Körnung K40 Mini flap disc Ø 50mm, 10pack, grid K40	1-04 1-20 2-04	235 018	Sägeblätter Z-18 Saw-blades Z-18	1-05 5-13 6-03	268 422/10	Ersatzklingen Stahl, 10 Pack à 10 Stück Spare blades steel, 10 pack à 10 pieces	6-10
			243 001	Karosserie-Meißel mit Handgriff Metal shield chisel	6-05	268 500	Zugmesser-Satz, 3-tlg. Pro-Xknife kit, 3pcs.	6-11
			243 002	Karosserie-Trennmeißel Weld breaker	6-05	270 006	Universal-Richteisen Universal door aligner	6-10
			243 002/H	Handgriff Protection rubber handle	6-05	271 001	Türfeder-Lösewerkzeug Spring clip remover	6-12
			243 002/HS	Karosserie-Trennmeißel mit Handgriff Weld breaker with protection rubber handle	6-05	271 200	Ablagetisch Windshield panel stand	6-12
			244 008	Bohrer HSSE 8,0 x 80mm Drill HSSE 8,0 x 80mm	5-08	272 040	Falz-Richtwerkzeug Join-straightener	6-13
			244 010	Bohrer HSSE 10,0 x 90mm Drill HSSE 10,0 x 90mm	5-08	272 090	Umschlagwerkzeug halbrund Bumping tool halfrounded	6-13
			244 060	Bohrer HSSE 6,0 x 70mm Drill HSSE 6,0 x 70mm	5-08	272 135	Profilrichtblock Typ 1, 135mm Profil straightener type 1, 135mm	6-14
						272 180	Rund-Amboss Round-anvil	6-13
						272 190	Handfaust flach und gewölbt Dolly flat and curved	6-14
						272 217	Richtklotz-Satz, 7-tlg. Flexy dolly set, 7 pcs.	6-15
						272 222	Gummi-Richtklotz Satz, 2-tlg. Flexy dolly set, 2 pcs.	6-16
						272 280	Kanten-Richtwerkzeug Edge-straightener	6-16
						272 333	Ausbeulsatz, 3-tlg. Bumping kit, 3 pcs.	6-16
						272 360	Profilrichtblock Typ 2, 360mm Profil straightener type 2, 360mm	6-14
						272 412	Universal-Ausbeulsatz Universal panel beating kit	6-17

## INDEX

272 680	Hebel- und Ausbeulwerkzeug Bumping spoon	6-18	280 002	Ausbeul-Pickeisen 400mm Body-pick 400mm	6-25	290 214	VIBRO-IMPACT® Austreiber 6,5mm VIBRO-IMPACT® pin 6.5mm	1-08 2-06 8-07
272 700	Uni-Zugbügel, komplett Uni pulling hook, complete	6-18	280 003	Ausbeul-Pickeisen 500mm Body-pick 500mm	6-25	290 217	VIBRO-IMPACT® Blech-Trenn-Meißel VIBRO-IMPACT® sheet metal cutter	1-08 2-06 8-07
276 310	LKW-Hebeleisen-Satz, 4-tlg. Heavy duty pry bar kit, 4 pcs.	2-02 6-19 7-05 8-02	280 004	Ausbeul-Pickeisen 800mm Body-pick 800mm	6-25	290 218	VIBRO-IMPACT® Flach-Meißel VIBRO-IMPACT® chisel separator	1-08 2-06 8-07
276 321	Schweres Teleskop-Hebeleisen 530-840mm Heavy duty extendable pry bar 530-840mm	2-03 6-20 7-06 8-03	280 007	Ausbeul- & Formpickeisen-Satz, 7-tlg. Body-pick kit, 7 pcs.	6-26	290 219	VIBRO-IMPACT® Halbrund-Meißel VIBRO-IMPACT® half round	1-08 2-06 8-07
276 323	Schweres Teleskop-Hebeleisen 760-1270mm Heavy duty extendable pry bar 760-1270mm	2-03 6-20 7-06 8-03	280 010	Formpickeisen Body-pick	6-25	290 226	VIBRO-IMPACT® Spurstangengabel 20mm VIBRO-IMPACT® Fork Chisel 20mm	1-09 2-07 8-08
276 340	Wandhalterung für Hebeleisen (ohne Werkzeuge) Steel wall rack (without tools)	2-02 6-19 7-05 8-02	280 011	Formpickeisen Body-pick	6-25	290 227	VIBRO-IMPACT® Spurstangengabel 25mm VIBRO-IMPACT® Fork Chisel 25mm	1-09 2-07 8-08
276 342	LKW-Hebeleisen "DUO-GRIF"® Heavy duty pry "DUO HANDLE"	2-02 6-19 7-05 8-02	280 012	Formpickeisen Body-pick	6-25	290 228	VIBRO-IMPACT® Spurstangengabel 32mm VIBRO-IMPACT® Fork Chisel 32mm	1-09 2-07 8-08
276 440	Montierereisen-Satz, 4-tlg. Pry bar kit, 4 pcs.	6-21	280 013	Formpickeisen-Satz, 3-tlg. Body-pick kit, 3 pcs.	6-25	290 231	Konkav-Austreiber Concave hammer insert	1-08 2-06 8-07
276 500	Gelenkkopf-Hebeleisen-Satz, 3-tlg. 240, 320 + 390mm Swivel head pry bar kit, 3 pcs. 240, 320 + 390mm	2-03 3-02 6-20 7-06 8-03	280 021	Formpickeisen Body-pick	6-26	290 236	Austreiber 8mm geschmiedet mit Zentrierkopf Pin driver 8mm, drop forged, center head	1-08 2-06 8-07
276 504	Gelenkkopf-Hebeleisen XL, 620mm Swivel head pry bar XL, 620mm	2-03 6-20 7-06 8-03	280 022	Formpickeisen Body-pick	6-26	290 237	Austreiber 10mm geschmiedet mit Zentrierkopf Pin driver 10mm, drop forged, center head	1-08 2-06 8-07
276 505	Gelenkkopf-Hebeleisen XL, 880mm Swivel head pry bar XL, 880mm	2-03 6-20 7-06 8-03	280 023	Formpickeisen Body-pick	6-26	290 238	Austreiber 12mm geschmiedet mit Zentrierkopf Pin driver 12mm, drop forged, center head	1-08 2-06 8-07
276 513	Doppelgelenk-Hebeleisen 380mm Double-joint pry bar 380mm	2-03 3-02 6-20 7-06 8-03	280 024	Formpickeisen-Satz, 4-tlg. Body-pick kit, 4 pcs.	6-26	290 239	Austreiber 12mm geschmiedet, Zylinderform Pin driver 12mm, drop forged, cylinder head	1-08 2-06 8-07
277 001	Zierleisten-Kunststoffkeil 30mm Trim wedge 30mm	6-21	280 111	Ausbeul- & Formpickeisen-Satz, 11-tlg. Body-pick kit, 11 pcs.	6-26	290 245	VIBRO-IMPACT® Nadelentrostler VIBRO-IMPACT® Needle Scaler	1-09 2-07 8-08
277 002	Zierleisten-Kunststoffkeil 60mm Trim wedge 60mm	6-21	282 001	Ausbeulwerkzeugsatz, 3-tlg. Bumping tool kit, 3 pcs.	6-27	290 250	VIBRO-IMPACT® Verschraubungs-Lösewerkzeug VIBRO-IMPACT® Threaded Fastener / Joint Release Tool	1-09 2-07 8-08
277 003	Demontagekeil 500mm Removal wedge 500mm	6-21	282 002	Kunststoff-Türrichtklotz Plastic door aligner	6-27	290 300	XL-VIBRO-IMPACT® Drucklufthammer Heavy Duty VIBRO-IMPACT® Air Hammer	1-10 2-08 8-09
277 004	Kunststoff-Kombi Keil Combi Wedge	6-24	282 003	Kunststoff-Körner Plastic center punch	6-27	290 310	XL-VIBRO-IMPACT® Spurstangen, 6-kant Schaft Heavy Duty VIBRO-IMPACT® tie rod	1-10 2-08 8-09
277 007	Clip + Sicherungszange Plastic Clip Pliers	6-22	282 004	Kunststoff-Kantenrichtblock Profile straightener	6-27	290 318	XL-VIBRO-IMPACT® Flachmeißel, 6-kant Schaft Heavy Duty VIBRO-IMPACT® flat chisel	1-10 2-08 8-09
277 007/10	Clip + Sicherungszange, 10 Stk. Plastic Clip Pliers, 10 pack	6-22	282 005	Kunststoffhammer 120mm, Ø 30mm Pick-hammer 120mm, Ø 30mm	6-27	290 320	XL-VIBRO-IMPACT® Hammer 6-kant Schaft Heavy Duty VIBRO-IMPACT® hammer	1-10 2-08 8-09
277 008	Clip Heber 5mm Clip Lifter 5mm	6-22 6-23 8-05	282 006	Kunststoffhammer 140mm, Ø 40mm Pick-hammer 140mm, Ø 40mm	6-27	290 331	XL-VIBRO-IMPACT® Konkav 6-kant Schaft Heavy Duty VIBRO-IMPACT® concave	1-10 2-08 8-09
277 009	Clip Heber 7mm Clip Lifter 7mm	6-23 8-05	282 160	Kunststoffhammer 160mm, Ø 40mm Pick-hammer 160mm, Ø 40mm	6-27	290 338	XL-VIBRO-IMPACT® Austreiber 20mm, 6-kant Schaft Heavy Duty VIBRO-IMPACT® pin driver 20mm	1-10 2-08 8-09
277 010	Clip Heber 5mm, halbrund Clip Lifter 5mm half-round	6-23 8-05	282 230	Klebegewicht-Entferner Wheel weight remover	3-04 7-07	290 432	Druckluft-Bohrmaschine 500 U/min Air drill 500 rpm	1-11 3-12
277 011	Clip Heber 11mm, S-Form Clip Lifter 11mm S-Form	6-23 8-05	282 240	Klebegewichtzange Wheel Weight Plier	3-04 7-07	290 433	Druckluft-Bohrmaschine 1.800 U/min Air drill 1.800 rpm	1-11
277 012	Clip Heber 11mm, gewinkelt Clip Lifter 11mm angled	6-23 8-05	282 260	Felgen-Radierschleibe Conical eraser for rims	1-24 3-07 6-32	290 434	SIGNAL-Gelenkschlauch SIGNAL Joint Hose	1-26
277 015	Clip Heber Set, 5-tlg. Clip Lifter Set, 5pcs.	6-23 8-05	290 040	Ersatzschleifband K-40 (VPE 25 Stück), braun Replacement belt K-40 (package 25 pcs.), brown	1-06 5-14 6-28	290 444	Druckluft-Winkelbohrmaschine Air angle drill	1-11 4-18
277 020	XL-Clip Heber S-Form, 370mm XL-Clip Lifter S-Shape, 370mm	6-23 8-05	290 041	Spezialschleifband K-40 (VPE 25 Stück), grün Special belt K-40 (package 25 pcs.), green	1-06 5-14 6-28	290 485	LKW-Reifenabdrücker Tyre Pusher	8-10
277 021	XL-Clip Heber XL-Clip Lifter	6-23 8-05	290 060	Ersatzschleifband K-60 (VPE 25 Stück), braun Replacement belt K-60 (package 25 pcs.), brown	1-06 5-14 6-28	294 113	1/4" Schlagschrauber, max. 90 Nm 1/4" Impact Wrench, max. 90Nm	1-14
277 022	XL-Clip Heber S-Form, 245mm XL-Clip Lifter S-Shape, 245mm	6-23 8-05	290 061	Spezialschleifband K-60 (VPE 25 Stück), grün Special belt K-60 (package 25 pcs.), green	1-06 5-14 6-28	294 114	1/2" Schlagschrauber, max. 1600 Nm 1/2" Impact Wrench, max. 1600Nm	1-14 3-06 8-11
277 023	XL-Clip Heber Set, 3-tlg. XL-Clip Lifter Kit 3-pcs	6-23 8-05	290 080	Ersatzschleifband K-80 (VPE 25 Stück), braun Replacement belt K-80 (package 25 pcs.), brown	1-06 5-14 6-28	294 114/orange	1/2" Schlagschrauber orange, max. 1600Nm 1/2" Impact Wrench orange, max. 1600Nm	1-15
277 046	Universal Haken Universal Hook	6-24	290 081	Spezialschleifband K-80 (VPE 25 Stück), grün Special belt K-80 (package 25 pcs.), green	1-06 5-14 6-28	294 114/SH	Schutzhülle für Müller 114 1/2" Protective cover for Müller 114 1/2"	1-13 3-07
277 047	Kunststoff-Kombi Keil und Universal Haken Combi Wedge and Universal Hook	6-24	290 113	MÜLLER Druckluftsäge MUELLER air saw	1-05 6-03	294 114/Signal	1/2" Schlagschrauber neon-grün, max. 1600 Nm 1/2" Impact Wrench neon-green, max. 1600Nm	1-15
277 072	Stufenheber Step lever	6-24	290 114	MÜLLER 114 Getriebe-Druckluftsäge MUELLER 114 Gear transmitted air saw	1-05 6-03	294 115	1/2" MINI-Schlagschrauber, max. 680 Nm 1/2" MINI-Impact Wrench, max. 680Nm	1-14 3-06 8-11
280 001	Ausbeul-Pickeisen 300mm Body-pick 300mm	6-25	290 120	Ersatzschleifband K-120 (VPE 25 Stück), braun Replacement belt K-120 (package 25 pcs.), brown	1-06 5-14 6-28	294 115/SH	Schutzhülle für Müller 115 1/2" Mini + 3/8 Protective cover for Müller 115 1/2" Mini + 3/8	1-13 3-07
			290 121	Spezialschleifband K-120 (VPE 25 Stück), grün Special belt K-120 (package 25 pcs.), green	1-06 5-14 6-28			
			290 165	DL-Bandschleifer komplett mit 15 Schleifbändern Air Belt Grinder complete with 15 belts	1-06 5-14 6-28			
			290 206	VIBRO-IMPACT® SYSTEM	1-07 2-05 8-06			

# INDEX

294 116	3/8" MINI-Schlagschrauber, max. 680 Nm 3/8" MINI-Impact Wrench, max. 680Nm	1-14 3-06 8-11	300 120/ALU	Alu-Hydraulik-Hohlkolbenzylinder 20 to. Aluminium Hollow piston 20 to.	9-04	404 780	SPITZNAGEL HSSE TICN 8,0 x 45mm SPITZNAGEL HSSE TICN 8,0 x 45mm	5-08
294 117	3/4" Schlagschrauber, max. 2600 Nm 3/4" Impact Wrench, max. 2600Nm	1-16 3-06 8-12	350 004	Einstellwerkzeug für Spritzdüsen Adjusting tool for spraying nozzle	6-33	430 001	Federbein-Spannzange Spring and absorber strut vice	2-09
294 117/SH	Schutzhülle für Müller 117 3/4" Protective cover for Müller 117 3/4"	1-13 3-07 8-12	350 350	Golf 4, Audi A3, Seat, Skoda Wischerarm-Reparaturset / Wiper arm repair kit	6-33	431 020	Stoßdämpfer-Montageeinheit Mounting unit for shock absorber	2-09
294 118/V2	1" Druckluft-Schlagschrauber, kurze Spindel 1" MUELLER Impact Gun, short anvil	1-18 8-13	350 354	VW Sharan, Ford Galaxy, Seat Alhambra Wischerarm-Reparaturset / Wiper arm repair kit	6-33	431 022	Uni-Klemmstück Uni-Clamp	2-09
294 119/V2	1" Druckluft-Schlagschrauber, lange Spindel 1" MUELLER Impact Gun, long anvil	1-18 8-13	350 500	Universal-Abziehsystem Universal pulling system	6-34	432 001	Universal Radlager-Werkzeug Universal wheel bearing tool	2-10
294 801	Magnethalter Fixpoint Magnet-holder	7-08	400 001/S	1/4" Stahl-Druckluftkupplung mit Außengewinde mit Gewindedichtung 1/4" Steel Couplings with outside thread	1-28	432 001/05	Trapezgewinde-Spindel Spindle	2-13
294 802	Magnethalter Fixpoint, 2 Stk. Magnet-holder, 2 pcs.	7-08	400 002/S	3/8" Stahl-Druckluftkupplung mit Außengewinde mit Gewindedichtung 3/8" Steel Couplings with outside thread	1-28	432 005	Doppel-Konus Radlagerwerkzeug Twin-cone wheel bearing kit	2-11
294 810	Magnethalter Fixpoint XL Magnet-holder XL	7-08	400 003/S	1/2" Stahl-Druckluftkupplung mit Außengewinde mit Gewindedichtung 1/2" Steel Couplings with outside thread	1-28	432 010-10/M	Halbschalensatz für Ø 66mm Lager Adapter for wheel bearing Ø 66mm	2-13
294 820	Magnethalter Fixpoint XL, 2 Stk. Magnet-holder XL, 2 pcs.	7-08	400 004/S	1/4" Stahl-Druckluftkupplung mit Innengewinde 1/4" Steel Couplings with inner thread	1-28	432 010-11/M	Halbschalensatz für Ø 62mm Lager Adapter kit for wheel bearing Ø 62mm	2-13
297 001	Mikro-Stabschleifer "BIONIGRIP" Micro Die Grinder "BIONIGRIP"	1-19	400 005/S	3/8" Stahl-Druckluftkupplung mit Innengewinde 3/8" Steel Couplings with inner thread	1-28	432 010-12/M	Halbschalensatz für Ø 72mm Lager Adapter kit for wheel bearing Ø 72mm	2-13
297 001/Kit5	Vollhartmetall-Frässtift-Satz, 5tlg. Carbide Milling and Grinding Burrs Set, 5 pcs.	1-19	400 006/S	1/2" Stahl-Druckluftkupplung mit Innengewinde 1/2" Steel Couplings with inner thread	1-28	432 010-13	Glocke Cap	2-13
297 001/KUD3	Kugelform 4,0mm, Schaft 3,0mm Ball Head burrs 4.0 mm Shank 3.0mm	1-19	400 008/S	Stahl-Druckluftkupplung für Schlauch-Innen-Ø 10mm Steel Couplings for hose inner-Ø 10mm	1-28	432 012	VW Radlagerwerkzeug Kompaktlager (HBU) VW Wheel bearing kit for HBU bearing	2-12
297 001/RBF3	Rundbogen 3,0mm Small rounded (Round tree) tip burrs 3.0mm	1-19	400 009/S	Stahl-Druckluftkupplung für Schlauch-Innen-Ø 13mm Steel Couplings for hose inner-Ø 13mm	1-28	432 013	Halbschalensatz für Ø 78mm Lager Adapter kit for wheel bearing Ø 78mm	2-13
297 001/SPG3	Spitzbogenform 3,0mm Pointed tip (Pointed tree) burrs 3.0mm	1-19	400 010/SR	Sicherheits-Stecknippel für Schlauch-Innen-Ø 10mm Safety Nipple for hose inner-Ø 10mm	1-28	432 014/M	Radlagerwerkzeug Ø 72mm komplett HBU wheel bearing kit Ø 72mm	2-13
297 001/W	Walzenrundform 3,0mm Rounded tip (Bull Nosed) burrs 3.0mm	1-19	400 013/SR	Sicherheits-Stecknippel für Schlauch-Innen-Ø 13mm Safety Nipple for hose inner-Ø 13mm	1-28	432 015	Radlagerwerkzeug VW T5 Wheel bearing kit VW T5	2-14
WRC3	Rundform (Bull Nosed) burrs 3.0mm		400 015/S/5	Industrie-Stahl-nippel für Schlauch-Innen-Ø 10mm Steel Nipples hardened for hose inner-Ø 10mm	1-28	432 016	Ergänzungssatz für 78mm HBU-Lager Additional kit for 78mm HBU-bearing	2-14
297 001/ZYB3	Zylinder stirnverzahnt 3,0mm Cylindrical with end cut burrs 3.0mm	1-19	400 016/S/5	Industrie-Stahl-nippel für Schlauch-Innen-Ø 13mm Steel Nipples hardened for hose inner-Ø 13mm	1-28	432 030	Universal-Radlager-Satz UNI wheel bearing kit	2-15
297 003	Mini Winkel-Trennschleifer Mini angle disc cutter	1-20	400 028/S/5	1/4" Industrie-Stahl-nippel mit Außengewinde mit Gewindedichtung 1/4" Steel Nipples hardened with outside thread	1-28	432 044	Radlager-Presswerkzeug FORD Transit 2000-2013 UNI-press-support	2-17
297 004	DL-Stabschleifer "BIONIGRIP" Air Die Grinder "BIONIGRIP"	1-21 6-29	400 029/S/5	3/8" Industrie-Stahl-nippel mit Außengewinde mit Gewindedichtung 3/8" Steel Nipples hardened with outside thread	1-28	432 045	FORD Transit Bremsscheiben-Trennwerkzeug FORD Transit Rear Disc Separator Kit	2-18
297 005	DL-Stabschleifer "BIONIGRIP" 90° Air Die Grinder "BIONIGRIP" 90°	1-22 6-30	400 030/S/5	1/2" Industrie-Stahl-nippel mit Außengewinde mit Gewindedichtung 1/2" Steel Nipples hardened with outside thread	1-28	432 200	Laageringstreiber PKW Bearing remover cars	2-18
297 008	1PS Druckluft-Tiefenschneider 1HP Extended Air Cutter	1-23 6-31	400 031/S/5	1/4" Industrie-Stahl-nippel mit Innengewinde 1/4" Steel Nipples hardened with inner thread	1-28	432 500	Laageringstreiber LKW, 500mm Bearing remover heavy duty, 500mm	2-18 8-16
297 010	Stabradierer komplett mit 1 Radierscheibe Ø 100mm Air Eraser complete with 1 erasing disc Ø 100mm	1-24 6-32	400 032/S/5	3/8" Industrie-Stahl-nippel mit Innengewinde 3/8" Steel Nipples hardened with inner thread	1-28	432 600	Universal Druckstücksatz Universal press disc kit	2-19
297 011	Radierscheibe Ø 100mm einzeln Erasing disc Ø 100mm separate	1-24 3-07 6-32	400 035	DL-Doppelgelenk 1/4" 2x 360° Air Swivel 2x 360°	1-26	432 650	Uni-Press-Unterlage UNI-press-support	2-20 8-17
297 013	Adapter für Bohrfutter Adapter for Drill-Chuck	1-24 3-07 6-32	400 036	Doppelgelenk mit Leistungsregler Swivel Joint with Regulator	1-26	432 700	Prismenplatte 4mm, extra dünn Press plate 4mm, extra thin	2-21
297 111	Radierscheiben Ø 100mm 10 Stk. + 1 Adapter für Bohrmaschine Erasing discs Ø 100mm 10 pcs. + 1 adaptor for drills	1-24 3-07 6-32	400 044/10	Schlauchklemmen für Druckluftschlauch Außen-Ø 14-17mm Hose Clamps for Air Hose outer-Ø 14-17mm	1-28	432 701	Prismenplatte 250x200x20mm Press plate 250x200x20mm	2-21
297 210	SIGNAL-Druckluftschlauch 10m x 10mm ohne Kupplung SIGNAL Air hose 3/8", 10m	1-27 8-15	400 048/10	Schlauchklemmen für Druckluftschlauch Außen-Ø 17-20mm Hose Clamps for Air Hose outer-Ø 17-20mm	1-28	432 711	Universal Press Ring	2-21
297 214	SIGNAL-Druckluftschlauch 10m x 10mm mit Kupplung DE & Rückschlagdämpfung SIGNAL Air hose 3/8", 10m with coupling DE & safety nipple	1-27 8-15	400 402	DL-Adapter-Satz, 2-tlg. Air adapter kit, 2 pcs.	8-16	432 800	Radschloss-Lösewerkzeug Lug nut remover kit	2-22
297 215	SIGNAL-Druckluftschlauch 50m x 10mm ohne Kupplung SIGNAL Air hose 3/8", 50m	1-27 8-15	403 120	VIBRO-IMPACT® Auspuffmeißel VIBRO-IMPACT® exhaust chisel	1-08 2-06 8-07	432 900	Universal Achshebel Universal axle bar	2-22
297 315	SIGNAL-Druckluftschlauch 50m x 13mm ohne Kupplung SIGNAL Air hose 1/2", 50m	1-27 8-15	403 192	Auspuff-Rohrerweiterer, 2-tlg. Exhaust pipe expander set, 2 pcs.	4-02	432 910	MÜLLER Achs- und Radspielprüfer Mueller suspension wear indicator	2-23
300 011	Zugspindel für Hydraulik M16 x 500mm Spindle for hydraulics M16 x 500mm	2-60 8-35 9-04	404 008	SPOTLE-Fräser HSSE TICN 8,0 x 39mm SPOTLE-drill HSSE TICN 8,0 x 39mm	1-03 5-08 5-09 6-04	433 100	Uni-Fahrwerksatz Suspension kit	2-24
300 013	Hydraulik-Hohlkolbenzylinder 12 to. Hollow piston 12 to.	2-60 9-04	404 080	SPOTLE-Fräser HSSE 8,0 x 39mm SPOTLE-drill HSSE 8,0 x 39mm	1-03 5-08 5-09 6-04	433 414	Original VIBRO-IMPACT® UNI-Antriebswellen-Durchdrücker / Radnaben-Abzieher UNI Drive shaft pusher / Hub puller	2-25
300 015	Hydraulik-Schlauch 700 bar, 2m Hydraulic hose 700 bar, 2m	2-60 2-61 8-35 9-03 9-04	404 108	VARIO-Fräser HSSE 8,0 x 44mm VARIO-drill HSSE 8,0 x 44mm	1-03 5-08 5-09 6-04	433 433	Basis-Flansch Basic flange	2-26
300 017	Zugspindel für Hydraulik M20 x 500mm Spindle for hydraulics M20 x 500mm	2-60 8-35 9-04	404 408	VARIO-Fräser HSSE TICN 8,0 x 44mm VARIO-drill HSSE TICN 8,0 x 44mm	1-03 5-08 5-09 6-04	433 435	Ergänzungssatz Additional kit	2-26
300 120	Hydraulik-Hohlkolbenzylinder 20 to. Hollow piston 20 to.	2-60 8-35 9-04	404 608	SPITZNAGEL HSSE 8,0 x 45mm SPITZNAGEL HSSE 8,0 x 45mm	5-08	433 436	Achsspiel-Prüfer Axle space detector	2-26
						433 437	Radnabenabzieher inkl. Gleithammer + Adapter Wheel hub basic unit incl. Slide hammer	2-29
						433 444	Radnabenabzieher Transporter Wheel hub puller heavy duty	2-27 8-18
						433 450/10	Außengewinde M20x2,5 outside thread M20x2,5	2-28 6-35 8-19
						433 450/11	Außengewinde M20x2,0 outside thread M20x2,0	2-28 6-35 8-19
						433 450/14	Außengewinde UN1 1/2" outside thread UN1 1/2"	2-26 2-28 6-35 8-19
						433 450/16	Außengewinde M42x2 z. B. KL outside thread M42x2 z. B. KL	2-28 6-35 8-19

## INDEX

433 450/25	Adapter z. B. für Doppelhaken Adapter e. g. for double hook	2-28 6-35 8-19	437 001/4	Ventildreher selbstklemmend, Satz 4-tlg. Valve Core Tool with valve core holder, Kit 4pcs.	3-15	463 007	Bremsleitungs-Biegezeuge Brake pipe bending pliers	3-26
433 450/27	Ausziehbügel M20x1,5 Universal hook M20x1,5	2-28 6-35 8-19	454 005	Bremsfederhaken LKW, 620mm Brake spring heavy duty, 620mm	8-16	463 009	Bremsleitungs-Rollen-Biegezeuge Brake pipe bending plier	3-26
433 450/28	Doppelhaken double hook	2-28 6-35 8-19	454 005/K	Bremsfederhaken IVECO, 450mm Brake spring IVECO, 450mm	8-16	463 020	Handbördelgerät Hand flaring tool	3-27
433 450/4	Außengewinde M16x2,0 outside thread M16x2,0	2-28 6-35 8-19	455 001	Bremsfederwerkzeuge Brake spring tool	3-16	463 020/HS	Hydraulikspindel für Bördelgerät Hydraulic spindle for hand flaring tool	3-27
433 450/45	Innengewinde UNC 5/8" inner thread UNC 5/8"	2-28 6-35 8-19	455 080	Müller Präzisions Montagehülsen Satz, 8-tlg. Mounting-sleeve kit, 8 pcs.	3-16	463 021	Bremsleitungsverbinder Made in Germany, 5er Pack Brake line connector 5pack	3-27
433 450/46	Innengewinde M16x2,0 inner thread M16x2,0	2-28 6-35 8-19	456 010	Bremsscheiben Schiebellehre digital Brake Disc Caliper Digital	3-17	463 022/ B475DIN	Bördeleinsatz 4,75 / 5mm DIN Flaring adapter 4.75 / 5mm DIN	3-27
433 450/48	Innengewinde M18x2,5 inner thread M18x2,5	2-28 6-35 8-19	456 011	Bremsscheiben Schiebellehre digital mit deutschem Kalibrierzertifikat Brake Disc Caliper Digital with German Certificate	3-17	463 022/ B475SAE	Bördeleinsatz 4,75 / 5mm SAE Flaring adapter 4.75 / 5mm SAE	3-27
433 450/49	Innengewinde M18x1,5 inner thread M18x1,5	2-28 6-35 8-19	456 110	ABS-Sensor-Satz ABS-Sensor kit	3-18	463 022/ B6DIN	Bördeleinsatz 6mm DIN Flaring adapter 6mm DIN	3-27
433 450/50	Innengewinde M20x2,5 inner thread M20x2,5	2-28 6-35 8-19	456 121	ABS-Reibahle Ø11mm ABS-reamer Ø11mm	3-18	463 022/ B6SAE	Bördeleinsatz 6mm SAE Flaring adapter 6mm SAE	3-27
433 450/51	Innengewinde M20x2,0 inner thread M20x2,0	2-28 6-35 8-19	456 150	ABS-Reibahle Ø15x23mm ABS-reamer Ø15x23mm	3-18	463 022/B- Konus	Bördeleinsatz 4,75 - 6mm Konus/SAE 90° Flaring adapter 4.75 - 6mm cone/SAE 90°	3-27
433 450/6	Außengewinde M18x2,5 outside thread M18x2,5	2-28 6-35 8-19	456 180	ABS-Reibahle Ø18x23mm VAG ABS-reamer Ø18x23mm VAG	3-18	463 022/K475	Klemmbackensatz 4,75mm DIN/SAE Jaws 4.75 DIN/SAE	3-27
433 450/8	Außengewinde M18x1,5 outside thread M18x1,5	2-28 6-35 8-19	456 181	ABS-Reibahle Ø18x34mm AUDI A4/A6 ABS-reamer Ø18x34mm AUDI A4/A6	3-18	463 022/K5	Klemmbackensatz 5mm DIN/SAE Jaws 5mm DIN/SAE	3-27
433 450/V2	Gleithammer Slide hammer	2-26	456 184	ABS-Reibahle Ø18x45mm LKW ABS-reamer Ø18x45mm LKW	3-18 8-16	463 022/K6	Klemmbackensatz 6mm DIN/SAE Jaws 6mm DIN/SAE	3-27
433 500	Radnabenschleifer Typ 1, 1/2" Antrieb, Ø 75mm innen Wheel hub grinder type 1, 1/2" drive, Ø 75mm internal	3-09	456 200	Gewinde-Rep.Satz M9x1,25 VAG Thread repair set M9x1,25 VAG	3-19	467 000	Bremssattel-Bürstensatz Brake caliper brush kit	3-28
433 501	Ersatzscheiben, VPE 3 Stk. für RNS Typ 1 Spare discs, 3 pcs.	3-08	456 210	Ersatzbüchsen + Kupferringe VPE 10 Stk. Thread inserts + copper rings 10pcs	3-19	467 001	Bremssattelbürste Stahl Brake caliper brush steel	3-28
433 502	Radnabenschleifer Typ 1, Ø 60mm innen Wheel hub grinder type 1, Ø 60mm internal	3-08	456 230	Gewinde Rep.Satz M9x1,25 OPEL Thread repair set M9x1,25 OPEL	3-19	467 002	Messing-Bremssattelbürste Brake caliper brush brass	3-28
433 503	Ersatzscheiben, VPE 3 Stk. für RNS Typ 1, 1/2" Spare discs, 3 pcs.	3-09	456 240	Gewinde Rep.Satz M9x1,25 FORD Thread repair set M9x1,25 FORD	3-19	468 015	Ratschenrücksetzer für Bremskolben Brake caliper press	3-28
433 504	Radnabenschleifer Typ 1, Ø 75mm innen Wheel hub grinder type 1, Ø 75mm internal	3-10	456 300	Bremssattel-Dichtstzreiner VAG Seal seat reamer for VAG	3-20	468 020	Bremskolben Druck-Drehvorrichtung Brake piston pressure-turn device	3-29
433 505	Ersatzscheiben für Radnabenschleifer Typ 1 Ø 75mm innen, VPE 3 Stk. Spare discs for wheel hub grinder 1, Ø 75mm internal, 3 pcs.	3-10	456 310	Bremssattel-Dichtstzreiner OPEL Seal seat reamer for OPEL	3-20	468 020/47	Druckscheibe 2 Arm 2 pin adjustable disc	3-30
433 507	Felgenflansch-Reiniger Inner Rim Cleaner	3-11	456 550/6	Bremsen-Innen-6-kant Satz Brake hex bit kit	3-19	468 020/48	Druckscheibe 3 Arm 3 pin adjustable disc	3-30
433 508	Ersatzscheiben für Felgenflansch-Reiniger VPE 3 Stk. Spare discs for inner rim cleaner, 3 pcs.	3-11	457 100	Leitungsschlüssel-Satz Line wrench kit	3-20	468 021	2 + 3 Arm Uni Bremsendruckscheiben Satz 2 + 3 pin adjustable disc Set	3-30
433 610	Alu-Radnabenschleifer Typ 2 Aluminium-Wheel hub grinder type 2	3-12	457 600	Bremsleitungs-Schlüsselsatz, 6-tlg. Brake line wrench kit, 6 pcs.	3-20	468 023	Uni Bremskolben Druck- und Drehvorrichtung Brake Piston Press and Turn Device	3-30
433 618	8-kant-Alu-Radnabenschleifer Typ 2 8-point-Alu-Wheel hub grinder type 2	3-13	457 701	Gelenkleitungsschlüssel 3-tlg. SW 14, 17, 19 Line wrench kit, 3pcs. 14, 17, 19mm	3-22	468 026	Druckluft-Bremsen-Rücksetzer Air brake piston resetter	1-31 3-29
433 618/M	8-kant-Alu-Radnabenschleifer Typ 2 8-point-Alu-Wheel hub grinder type 2	3-13	457 703	Gelenkleitungsschlüssel 3-tlg. SW 10, 11, 12 Line wrench kit, 3pcs. 10, 11, 12mm	3-22	500 012	Schlauchklemmzange mit Arretierung Hose clamp plier flexible	4-02
433 640	Ersatzscheiben klein, VPE 5 Stk. Spare discs small, 5 pcs.	3-12	457 705	Gelenkleitungsschlüssel 5-tlg. SW 8, 9, 10, 11, 12 Line wrench kit, 5pcs. 8, 9, 10, 11, 12mm	3-22	500 014	Spezialklemmzange mit Arretierung Special hose clamp plier flexible	4-02
433 648	8-kant-Ersatzscheiben klein, VPE 5 Stk. 8-point-spare discs small, 5 pcs.	3-13	458 600	Entlüfterschlüsselsatz Brake bleeder wrench set	3-21	500 015	Schlauchklemmspanner Typ 1 Hose clamp compressor type 1	4-02
433 650	Ersatzscheiben groß, VPE 5 Stk. Spare discs large, 5 pcs.	3-12	458 711	Bremsenentlüfterschlüssel SW11 Brake line wrench 11mm	3-23	500 016	Schlauchklemmspanner Typ 2, VW/Audi Hose clamp compressor type 2, VW/Audi	4-02
433 658	8-kant-Ersatzscheiben groß, VPE 5 Stk. 8-point-spare discs large, 5 pcs.	3-13	458 711-3	Silikonschlauch für Bremsenentlüfterschlüssel Silicon-hose incl. Nipple	3-23	500 030	Doppelgelenk-Schlauchschellen Zangen-Satz 2tlg. Double-X-hose clamp plier kit	4-03
433 700	Radnabenschleifer Typ 3 Wheel hub grinder type 3	3-14 8-20	458 811	Bremsenentlüfterschlüssel SW11 kurz Brake line wrench 11mm short	3-23	500 035	Schlauchschellen-Zangensatz 2tlg. 2pcs hose clamp plier kit	4-03
433 720	Ersatzscheiben, VPE 2 Stk. Spare discs, 2 pcs.	3-14 8-20	460 200/M	Bremssattelteile mit Heft Brake caliper file with handle	3-23	500 109	Zange für Clic-Schellen drehbar Plier for hose clic clamp	4-04
433 918	8-kant LKW-Radnabenschleifer Typ 4 8-point wheel hub grinder type 4	3-15 8-20	460 202/M	Bremssattelteile extra schmal für japanische Fahrzeuge Brake caliper thin for Japanese vehicles	3-23	500 109/ Promo	6 Zangen im Display 6 Pliers in a display	4-04
433 958	8-kant Ersatzscheiben Typ 4, VPE 5 Stk. 8-point spare discs, 5 pcs.	3-15 8-20	460 220	Bremsen-Honbürstensatz 2-tlg. Brake honing brush set 2 pcs.	3-24	500 110	Schlauchklemmzange für Clic-Schellen Hose clamp plier for hose clic clamps	4-04
433 958/PUR	8-kant Ersatzscheiben grob, VPE 5 Stk. 8-point spare discs rough, 5 pcs.	3-15 8-20	462 002	Mini-Ratschen Rohrabscneider Ø 4,75mm, 3/16" Mini-ratchet pipe cutter Ø 4.75mm, 3/16"	3-24	501 700	Vakuum-Kühler Füllgerät Vacuum cooling system filler	4-05
437 001	Ventildreher selbstklemmend Valve Core Tool with valve core holder	3-15	462 004	Abmantelwerkzeug für Bremsleitungen Brake pipe coating removal tool	3-24	505 000	Gewinde-Reparatur-Satz M5, M6, M8+ M10 Thread repair system MS, M6, M8 + M10	4-05
			462 040	Bremsleitungs-Richtwerkzeug Brake line straightener	3-25	505 004	Gewinde-Reparatur-Werkzeug M4 Thread Repair Kit M4	4-06 5-14
			463 001	Bördelgerät Flaring tool	3-25	505 005	Gewinde-Reparatur-Werkzeug M5 Thread Repair Kit M5	4-06 5-14
			463 001/B475	Bördeleinsatz 4,75mm Flaring adapter 4.75mm	3-25	505 006	Gewinde-Reparatur-Werkzeug M6 Thread Repair Kit M6	4-06 5-14
			463 001/B600	Bördeleinsatz 6,00mm Flaring adapter 6.00mm	3-25	505 006/MB	Reparatursatz für Injektoren-Spannschraube M6 Injector bolt repair set M6	4-06
			463 001/K475	Klemmbackensatz 4,75mm Jaws 4.75mm	3-25	505 007	Gewinde-Reparatur-Werkzeug M7 Thread Repair Kit M7	4-06 5-14
			463 001/K600	Klemmbackensatz 6,00mm Jaws 6.00mm	3-25	505 007/MB	Reparatursatz für Injektoren-Spannschraube M7 Injector bolt repair set M7	4-06
			463 006	Bremsleitungs-Biegevorrichtung Brake pipe bender	3-26	505 008	Gewinde-Reparatur-Werkzeug M8 Thread Repair Kit M8	4-06 5-14
						505 010	Gewinde-Reparatur-Werkzeug M10 Thread Repair Kit M10	4-06 5-14

# INDEX

505 012	Gewinde-Reparatur-Werkzeug M12 Thread Repair Kit M12	4-06 5-14	512 631	Ersatzschwenkkopf 3/4" Swivel Head 3/4"	7-10 8-25	562 300	Linksbohrer-Satz für Schraubenausdreher HSSE-TIN Left drill bit kit HSSE-TIN	5-10
505 014	Gewinde-Reparatur-Werkzeug M14 Thread Repair Kit M14	4-06 5-14	512 712	Uni-Spurschlüssel Daimler Wheel alignment wrench Mercedes	2-30	562 400	Spiralbohrersatz, HSSE-TIN, linksschneidend, 4-tlg. Left drill bit kit, HSSE-TIN, 4 pcs.	5-11
505 016	Gewinde-Reparatur-Werkzeug M16 Thread Repair Kit M16	4-06 5-14	514 100	Betätigungsschlüssel für 5/16" Bits Special wrench bits 5/16"	6-36	562 600	Hartmetallbohrer Satz 4 tlg. Carbide tip drills kit 4pcs.	5-11
505 018	Gewinde-Reparatur-Werkzeug M18 Thread Repair Kit M18	4-06 5-14	514 110	Türeinsteilschlüssel M10 Door Hinge wrench M10	6-36	562 800	Spiralbohrersatz, HSSE-TIN, linksschneidend, 8-tlg. Left drill bit kit, HSSE-TIN, 8 pcs.	5-11
505 104	Ersatz-Büchsen M4 Thread inserts M4	4-06 5-14	514 145	Türeinsteilschlüssel TX45 Door Hinge wrench TX45	6-36	562 900	Schrauben-Ausdrehsatz 9-tlg. Screw extractor kit 9 pcs.	5-12
505 105	Ersatz-Büchsen M5 Thread inserts M5	4-06 5-14	514 300	Sturz-Einstellwerkzeug Wheel camber adjuster	2-30	570 600	Speziellschlüssel für Motorraum Engine + timing belt wrench	4-11
505 106	Ersatz-Büchsen M6 Thread inserts M6	4-06 5-14	514 300/2	Sturz-Einstellwerkzeug, 2-tlg. Satz Wheel camber adjuster 2pcs.	2-30	571 050	Klauenschlüsselsatz, 5-tlg. 8, 9, 21, 22, 24mm Crow foot wrench kit, 5 pcs. 8, 9, 21, 22, 24mm	7-14
505 107	Ersatz-Büchsen M7 Thread inserts M7	4-06 5-14	514 333	Spur- & Türscharniersatz Wheel camber & door hinge kit	6-36	571 100	Klauenschlüsselsatz, 10-tlg. 10 - 19mm Crow foot wrench kit, 10 pcs. 10 - 19mm	7-14
505 108	Ersatz-Büchsen M8 Thread inserts M8	4-06 5-14	514 600	XS-Bit Satz XS-Bit Kit	3-31	571 200	Klauenschlüsselsatz, 15-tlg. 8 - 24mm Crow foot wrench kit, 15 pcs. 8 - 24mm	7-14
505 110	Ersatz-Büchsen M10 Thread inserts M10	4-06 5-14	515 006	Vakuum-Absaugpumpe 6,5 Liter Vacuum oil and liquid Extractor 6.5 litre	7-11	571 250	Leitungsschlüsselsatz, 19-41mm Crow foot wrench kit, 19-41mm	8-26
505 112	Ersatz-Büchsen M12 Thread inserts M12	4-06 5-14	515 007/4	Schlauchsortiment für Dieselfilter-Füllgerät, 4-tlg. Silicone hose kit for diesel filter filler, 4 pcs.	4-09	600 105	Abzieher für Injektor-Kupfer-Dichtring Remover for injector copper seal	4-11
505 114	Ersatz-Büchsen M14 Thread inserts M14	4-06 5-14	515 007/V2	Dieselfilter-Füllgerät Diesel filter filler	1-30 4-09 8-25	600 111	Universal Dichtstreifenreiner Typ 1 Universal reamer kit type 1	4-12
505 116	Ersatz-Büchsen M16 Thread inserts M16	4-06 5-14	515 008	Absaugbalg Fluid suction device	3-32	600 114	Universal Dichtstreifenreiner Typ 2 Universal reamer kit type 2	4-12
505 208	Gewinde-Reparatur-Werkzeug M8x1 Thread Repair Kit M8x1	4-06 5-14	515 009/V2	Universal Bremsen-Entlüfter Universal brake bleeder	1-30 3-32	600 116	Universal Dichtstreifenreiner Universal seal seat cleaner	4-13
505 210	Gewinde-Reparatur-Werkzeug M10x1,25 Thread Repair Kit M10x1,25	4-06 5-14	531 010	1/2" Drehmomentschlüssel 20-200Nm 1/2" Torque wrench 20-200 Nm	3-33	600 120	Injektoren-Auszehvorrichtung Injector extractor	4-13
505 212	Gewinde-Reparatur-Werkzeug M12x1,5 Thread Repair Kit M12x1,5	4-06 5-14	531 049	TPMS/RDKS Werkzeug-Satz TPMS/RDKS Tool kit	3-34	600 122	Schlagauszieher für Injektoren Slide hammer for injectors	4-14
505 214	Gewinde-Reparatur-Werkzeug M14x1 Thread Repair Kit M14x1,5	4-06 5-14	531 054	TPMS/RDKS Reifenentlüfter 4-tlg. Tyre Deflator Kit, 4pcs.	3-33	600 127	VIBRO-IMPACT® Zugeinheit inkl. Adapter VIBRO-IMPACT® pull unit incl. Adapter	4-15
505 216	Gewinde-Reparatur-Werkzeug M16x1,5 Thread Repair Kit M16x1,5	4-06 5-14	537 700	Antriebswellen-Montagehilfe M16x1,5 Drive shaft mounting kit M16x1,5	2-31	600 128	VIBRO-IMPACT® Zugeinheit inkl. Drucklufthammer und Adapter VIBRO-IMPACT® pull unit incl. air hammer and adapter	4-15
505 218	Lambdasonden-Reparatur-Satz Repair kit for oxygen sensor	4-07	537 710	Antriebswellen-Trenner M16x1,5 Drive shaft separator M16x1,5	2-31	600 130	Uni-Injektor-Ausziehsatz Uni injector puller kit	4-20
505 218/L	Gewinde-Reparatur-Werkzeug M18x1,5 Thread Repair Kit M18x1,5	4-06 5-14	541 101	Keilzahn-Satz, 14-tlg. Keilzahn ribe set, 14 pcs.	7-11	600 140	Spannplatten für Injektoren, 2-tlg. Clamping plate for injectors, 2 pcs.	4-16
505 308	Ersatz-Büchsen M8x1 Thread inserts M8x1	4-06 5-14	541 101/KV	Keilzahn-Satz & Bitverlängerung 5/16" Keilzahn ribe set & bit extension 5/16"	7-11	600 150	Injektoren-Stecknuss-Satz, 4-tlg. Injector socket kit, 4 pcs.	4-16
505 310	Ersatz-Büchsen M10x1,25 Thread inserts M10x1,25	4-06 5-14	541 306	Keilzahn-Stecknuss M6 x 250mm x 1/2" Keilzahn-Ribe Socket M6 x 250mm x 1/2"	7-12	600 206	Abdreher für Glühkerzenelektroden Glow plug extractor kit	4-16
505 312	Ersatz-Büchsen M12x1,5 Thread inserts M12x1,5	4-06 5-14	541 307	Keilzahn-Stecknuss M7 x 250mm x 1/2" Keilzahn-Ribe Socket M7 x 250mm x 1/2"	7-12	600 240	Ausbohrersatz für Glühstifte M10 x 1 Drill kit for glow plugs M10 x 1	4-17
505 313	Ersatz-Büchsen M12x1,25 Thread inserts M12x1,25	4-06 5-14	541 308	Keilzahn-Stecknuss M8 x 250mm x 1/2" Keilzahn-Ribe Socket M8 x 250mm x 1/2"	7-12	600 242	Ausbohrersatz für Glühstifte M12 x 1,25 Drill kit for glow plugs M12 x 1,25	4-17
505 314	Ersatz-Büchsen M14x1,5 Thread inserts M14x1,5	4-06 5-14	541 309	Keilzahn-Stecknuss M9 x 250mm x 1/2" Keilzahn-Ribe Socket M9 x 250mm x 1/2"	7-12	600 245	Ausbohrersatz für Glühstifte M10 x 1,25 Drill kit for glow plugs M10 x 1,25	4-17
505 316	Ersatz-Büchsen M16x1,5 Thread inserts M16x1,5	4-06 5-14	541 310	Keilzahn-Stecknuss M10 x 250mm x 1/2" Keilzahn-Ribe Socket M10 x 250mm x 1/2"	7-12	600 248	Ausbohrersatz für Glühstifte M8 x 1 Drill kit for glow plugs M8 x 1	4-17
505 318/L	Ersatz-Büchsen M18x1,5 Thread inserts M18x1,5	4-06 5-14	541 311	Keilzahn-Stecknuss M11 x 250mm x 1/2" Keilzahn-Ribe Socket M11 x 250mm x 1/2"	7-12	600 249	Ausbohrersatz für Glühstifte M9 x 1 Drill kit for glow plugs M9 x 1	4-17
505 319	Ersatz-Büchsen M18 Thread inserts M18	4-06 5-14	541 312	Keilzahn-Stecknuss M12 x 250mm x 1/2" Keilzahn-Ribe Socket M12 x 250mm x 1/2"	7-12	600 250	Glühkerzen-Reibahle M10 Glow plug reamer M10	4-18
505 412	Gewinde-Reparatur-Werkzeug Kit M14x1,25 Thread Repair Kit M14x1,25	4-06 5-14	541 313	Keilzahn-Stecknuss M13 x 250mm x 1/2" Keilzahn-Ribe Socket M13 x 250mm x 1/2"	7-12	600 258	Glühkerzen-Reibahle M8 Glow plug reamer M8	4-18
505 414	Ersatz-Büchsen M14x1,25 Thread inserts M14x1,25	4-06 5-14	541 314	Keilzahn-Stecknuss M14 x 250mm x 1/2" Keilzahn-Ribe Socket M14 x 250mm x 1/2"	7-12	600 289	Glühkerzen Vibro-Ausdreher Glow plug vibro extractor	1-25 4-19
505 812	Gewinde-Reparatur-Werkzeug M12x1,25 Thread Repair Kit M12x1,25	4-06 5-14	544 020	Torx-Shok-Satz, 12-tlg. Torx shok set, 12 pcs.	7-12	600 300	Glühspitzen-Ausbohrersatz universal Complete kit for glow plugs electrode extraction	4-20
506 318	Lambdasondenschlüssel Oxygen sensor socket	4-07	545 600	Gelenk 6-kant Stiftschlüssel Satz 6-tlg. Joint hex key kit 6pcs.	3-34 7-13	601 700	Planfräsvorrichtung V.A.G. 4 Zylinder Motoren Crankshaft milling tool V.A.G. 4 cylinder	4-21
510 001	Motor-Brücke Engine hanger	4-07	545 700	Gelenk T Schlüssel Satz 6-tlg. Joint T-key kit 6pcs.	3-34 7-13	602 050	Universal Riemenscheibenabzieher Universal pulley puller	4-21
510 051	Sicherheits-Montagetritt, 2-stufig Safety mounting step	7-09 8-24	546 006	Schlauchklemmen-Set, 6-tlg. Hose clamp kit, 6 pcs.	4-09	603 334	Ausbohrersatz 4-Linker-Achsen Drilling out set 4-Link Suspension	2-32
510 051/A2	Sicherheits-Montagetritt, 2-stufig, 2 Stk. Safety mounting step, 2 pcs.	7-09 8-24	551 005	Universal-Bandschlüssel Universal Belt Wrench	8-21	603 336	Ausbohrersatz Alu-4-Linker-Achsen Pinch Bolt Removal Kit	2-32
510 099	Rollbrett Creeper	7-10	556 000	Motoröl-Fülltrichter mit Bajonetverschluss Motor-oil funnel with Quick Coupling	4-10	603 718	LKW-Zentrierhülsen M18x1,5 Center sleeve kit M18x1,5	8-26
510 099/4E	Ersatzrollen, VPE 4 Stk. Single wheels, 4 pcs.	7-10	556 006	Motoröl-Fülltrichter z. B. Golf 7 etc. Motor-oil funnel e. g. Golf 7 etc.	4-10	603 720	LKW-Zentrierhülsen M20x1,5 Center sleeve kit M20x1,5	8-26
512 002	Spurstangenange Universal Tie Rod Wrench	2-29	556 040	Fluid controller Typ 1, 370 x 170mm Fluid controller type 1, 370 x 170mm	4-10	603 722	LKW-Zentrierhülsen M22x1,5 Center sleeve kit M22x1,5	8-26
512 050	Shock-Kugelgelenk-Ausdreher Tie rod end socket	2-30	556 050	Fluid controller Typ 2, 410 x 200mm Fluid controller type 2, 410 x 200mm	4-10	604 230	Uni-Montagehaken Satz, 3-tlg. Multi function micro tool kit, 3 pcs.	7-14
512 610	1/2" x 600mm Knarren-Knebel 1/2" x 600mm Ratchet breaker bar	3-31 7-10 8-25	558 001	6-kant Winkel-Stiftschlüssel Satz 100° HEX color coded kit 100°	7-13	604 785	Airbag-Lösewerkzeug V.A.G. Airbag-tool V.A.G.	6-37
512 611	Ersatzschwenkkopf mit Knarrenfunktion 1/2" Ratchet angle head 1/2"	7-10 8-25	558 100	TORX Winkel-Stiftschlüssel Satz 100° TORX color coded kit 100°	7-13	604 785/3	Airbag-Lösewerkzeug V.A.G., 3-tlg. Airbag-tool V.A.G., 3 pcs.	6-37
512 630	Knebel 700mm x 3/4" Breaker bar 700mm x 3/4"	7-10 8-25	562 180	XL-Linksbohrer-Satz HSSE-TIN, 5-tlg. XL-left drill bit kit, 5 pcs.	5-10			

## INDEX

608 950	Exzenter Klemm-/ Drehvorrichtung Excentric turn chuck	2-33	609 311	Uni. Pressrahmen inkl. 10 ton. Hydraulik-Einheit Uni. base frame incl. 10 ton. hydraulic unit	2-38	660 001	Zylinder-Dichtigkeits-Prüfergät Cylinder head tester	4-23
609 001	Kugelenkabzieher Ball joint separator	2-34	609 312	Uni. Pressrahmen inkl. 12 ton. Hydraulikspindel Uni. base frame incl. 12 ton. hydraulic spindle	2-38	660 002	Testflüssigkeit Test liquid	4-23
609 003	Kugelenkabzieher mechanisch Ball joint separator	8-27	609 315	XL Press-Rahmen mit VIBRO-IMPACT® Spindel XL Press-Frame incl. VIBRO-IMPACT® Spindle	2-38 2-39	660 003	Reinigungslösung Cleaning liquid	4-23
609 030	Abziehglocke 30mm Bell shape 30mm	2-35	609 316	XL Press-Rahmen ohne Spindel XL Press Frame without Spindle	2-39	660 200	Zylinder-Druckverlust-Tester Cylinder leakage tester	4-23
609 032	Abziehglocke 32mm Bell shape 32mm	2-35	609 390	XS Druck- und Zughülzensatz XS press and pull sleeve kit	2-45 8-28	700 161	Scheibenwerkzeug-Satz Window-Tool	6-37
609 033	VIBRO-IMPACT® Abziehsystem VIBRO-IMPACT® Ball joint separating kit	2-36	609 390/Basic	XS Ergänzungssatz für Nr. 609 400 Basic XS press and pull sleeve kit, Kombi kit for no. 609 400	2-45 8-28	702 270	Magneheber biegsam Flexible Magnetic Pick Up Tool	7-17
609 033/5	VIBRO-IMPACT® Abziehsystem VIBRO-IMPACT® Ball joint separating kit	2-36	609 399	Universal Druck- und Zughülzensatz Basic Universal press and pull sleeve kit basic	2-46	711 100	Maul-Ringschlüssel Satz extra kurz Combination Wrench Kit	3-35 7-17
609 033-WH	Wandhalterung Wall Mount	2-36	609 400	Universal Druck- und Zughülzensatz Typ 1 Universal press and pull sleeve kit type 1	2-47 8-29	727 006	Funktionsprüflampe, 6m Kabel Multi-function Test Lamp, 6m cable	7-18 8-39
609 035	Abziehglocke 35mm Bell shape 35mm	2-35 8-27	609 400/460	Universal Druck- und Zughülzensatz Press and Pull Sleeve Combination Kit	2-48 8-30	727 006/25	Funktionsprüflampe, 25m Kabel Multi-function Test Lamp, 25m cable	7-18 8-39
609 039	Abziehglocke 39mm Bell shape 39mm	2-35 8-27	609 420	Universal Druck- und Zughülzensatz Typ 2 Universal press and pull sleeve kit type 2	2-49 8-31	727 010	Prüf- & Testleitungs-Satz, 14-tlg. Test cable kit, 14 pcs.	7-19
609 101/4	Kugelenkabzieher 4-fach verstellbar Ball joint separator 4-way	2-34	609 420/Basic	Druck- und Zughülzensatz Typ 2 Basic Universal press and pull sleeve kit type 2 basic	2-50	727 030	Leitungs-Demontagesatz Line coupling disconnect kit	7-19
609 103	Kugelenkabzieher hydraulisch 12 to. Ball joint separator hydraulic 12 to.	8-27	609 420/	Druck- und Zughülzensatz Typ 2 Upgrade Universal press and pull sleeve kit type 2 upgrade	2-50	727 040	Kabelverbinder-Entrieglungs-Satz Cable-disconnect-kit	7-20
609 114	Druckstücksatz für DB W124, 129, 201 Pressure piece kit for DB W124, 129, 201	2-37	609 450	Grundgerät C-Bügel, klein Basic C-clamp, small	2-51	727 090	4 in 1 Refraktometer DEF / AD-Blue 4-in-1 Refractometer	4-24
609 115	Universal Pressrahmen Universal base frame	2-38 8-32	609 460	Universal C-Bügel Typ 2 Universal C-Frame type 2	2-52	727 200	Powersafe PKW 12V Powersafe for vehicles 12V	4-24
609 115/DZ	Ergänzungssatz für Nr. 609 115 zur Verwendung mit Druck- und Zughülzensätzen Kit for no. 609 115 for usage with press and pull sleeve kits	2-39	609 465	C-Bügel und Pressrahmen-Satz C-Frame and base frame kit	2-55	727 224	Powersafe LKW 24V Powersafe for trucks 24V	4-24
609 120	Universal Pressrahmen inkl. Adapter-Satz passend für 609 400 Universal base frame incl. adapter-kit fits for 609 400	2-38 8-34	609 471	Druckstücksatz Drehtabgelenk Adapter kit torsion ball joint	2-51	727 700	Außengewinde-Nachschneider Thread restorer	8-39
609 131	FORD Transit Kugelenkabzieher-Presswerkzeug FORD Transit Ball Joint Tool	2-40	609 472	Druckstücksatz Tragelenk Adapter kit ball joint	2-51	727 703	Ersatz-Strehlerplatten, metrisch, 2-tlg. Thread restorer plate kit, metric	8-39
609 137	Druckstücksatz für BMW (3er), E36 Pressure piece kit for BMW (3er), E36	2-37	622 100	Ölwanne-Reparaturkit M14x1,5 auf M15x1,5 Oil pan repair kit M14x1,5 auf M15x1,5	4-22	727 704	Ersatz-Strehlerplatten, Zoll, 4-tlg. Thread restorer plate kit, inch.	8-39
609 138	FORD Transit Druckstücksatz FORD Transit Arm Bush Tool	2-40	622 300	Ersatzschrauben mit Dichtung M15x1,5, 10 Stk. Spare screw with seals M15x1,5, 10 pcs.	4-22	731 031	Drehknopfknarre 3/8" Swivel joint ratchet 3/8"	7-18
609 144	Druckstücksatz für VW T4 ab Bj. '92 Pressure piece kit for VW T4 ab Bj. '92	2-37 8-34	622 600	Ölwanne-Reparaturkit M18x1,5 auf M20x1,5 Oil pan repair kit M18x1,5 auf M20x1,5	4-22	741 041	Drehknopfknarre 1/2" Swivel joint ratchet 1/2"	7-18
609 145	Druckstücksatz für Renault Laguna Pressure piece kit for Renault Laguna	2-37	622 610	Ersatzschrauben mit Dichtung M20x1,5, 10 Stk. Spare screw with seals M20x1,5, 10 pcs.	4-22	745 100/PW	Uni Verlängerer Typ 1 Uni extender type 1	7-20 8-40
609 146	Druckstücksatz für VW Golf 3 Pressure piece kit for VW Golf 3	2-41	623 201	Glühkerzengewinde-Rep. M10x1,25 Repair kit glow plug M10x1,25	4-22	745 102	Uni Verlängerer Typ 2 Uni extender type 2	7-20 8-40
609 147 / 312 / 035	Kombi Set 12 to. Hydraulikspindel Combi kit with 12 to. Hydraulic spindle	2-42	623 208	Glühkerzengewinde-Rep. M8x1 Repair kit glow plug M8x1	4-22	748 104	Montagezangen Satz, 4-tlg. Long nose plier kit, 4 pcs.	7-21
609 147/V2	Druckstücksatz für VW LT + DB Sprinter Pressure piece kit for VW LT + DB Sprinter	2-37 8-34	623 209	Glühkerzengewinde-Rep. M9x1 Repair kit glow plug M9x1	4-22	748 200/2	Doppelgelenk-Zangensatz 2-tlg. 2-Joint Plier Kit	4-25
609 148	Druckstücksatz für BMW (3er) E30 Pressure piece kit for BMW (3er) E30	2-37	623 210	Glühkerzengewinde-Rep. M10x1 Repair kit glow plug M10x1	4-22	748 200/3	Doppelgelenk-Zangensatz 3-tlg. 2-Joint Plier Kit	4-25
609 149	Druckstücksatz für Renault Master/Opel Movano Pressure piece kit for Renault Master/Opel Movano	2-37 8-34	623 212	Glühkerzengewinde-Rep. M12x1,25 Repair kit glow plug M12x1,25	4-22	748 200/5	Doppelgelenk-Zangensatz 5-tlg. 2-Joint Plier Kit	4-25
609 150	Druckstücksatz für Renault Master/Opel Movano Pressure piece kit for Renault Master/Opel Movano	8-34	623 214	Zündkerzengewinde-Rep. M14x1,25 Repair kit spark plug M14x1,25	4-22	748 300	Spezial-Zangensatz "GUN TYPE" Plier kit "GUN TYPE"	4-26
609 164	Druckstücksatz für VW Golf 1/2/3, Vento, Passat Pressure piece kit for VW Golf 1/2/3, Vento, Passat	2-41	650 200	Universal Lagerringabzieher Universal race ring puller	2-56	767 700	Schneideisen-Adaptersatz Die adapter kit	8-40
609 165	Druckstücksatz für VW Golf 3 Variant, Passat Pressure piece kit for VW Golf 3 Variant, Passat	2-41	650 210	Lagerringabzieher VW-Gruppe Neu Bearing race puller VW/AUDI	2-57	782 100	Verlängerungssatz "Quikfix" Extension set "Quikfix"	7-21
609 166	Druckstücksatz VW Polo 9N Adapter kit VW Polo 9N	2-42	650 400	Abziehsystem für Lagerringe Pulling system for bearing rings	2-58	782 500	Kardangeln-Stecknuss-Satz 12-point universal joint socket set	7-22
609 168	Druckstücksatz für VW Golf 4, Audi A2/A3 Pressure piece kit for VW Golf 4, Audi A2/A3	2-41	650 700	Uni-Abziehsystem 2+3 Arm, hydraulisch Hydraulic Twin / Triple Leg Puller System	7-15	800 005	Schutzkappenheber Speed loader	3-35
609 171	Druckstücksatz für DB W202, C-Klasse Pressure piece kit for DB W202, C-Klasse	2-41	650 700-1	Hydraulikspindel komplett Hydraulic Ram complete with nose piece	7-16	800 005/3	Schutzkappenheber VPE 3 Stk. Speed loader, 3 pcs.	3-35
609 172	Druckstücksatz für DB W210, E-Klasse Pressure piece kit for DB W210, E-Klasse	2-41	650 700-11	Abzieharm 250mm Puller Leg 250mm	7-16	800 005/M	Schutzkappenheber mit Haltemagnet Speed loader incl. Magnet holder	3-35
609 175	Druckstücksatz für Renault Laguna Pressure piece kit for Renault Laguna	2-41	650 700-2	Abziehbücke 2-Arm Twin Head Assembly	7-16	800 100	Stecknuss-Satz für Alufelgen Socket set for aluminium rims	1-29 3-36
609 180	Druckstücksatz für BMW E36/E46 Pressure piece kit for BMW E36/E46	2-41	650 700-3	Abziehbücke 3-Arm Triple Head Assembly	7-16	800 200	XL-Radmontage Stecknuss-Satz 3-tlg. XL wheel mounting socket kit 3 pcs.	1-29 3-36
609 206	10 to. Hydraulik Zylinder 10 to. hydraulic cylinder	2-39	650 700-4	Kolbenverlängerung 150mm Ram Extension 150mm	7-16	800 610	Uni-Adaptersatz, 2-tlg. Uni-Adapter kit, 2 pcs.	7-22
609 210	12 to. Hydraulikspindel 12 to. hydraulic spindle	2-26 2-39	650 700-5	Kolbenverlängerung 100mm Ram Extension 100mm	7-16	801 800	3/4" Impact Stecknuss Satz 3/4" Impact Socket Kit	1-31 8-41
609 214	Spindel mechanisch, TR27 inkl. Adapter Mechanic spindle, TR27 incl. Adapter	2-39	650 700-6	Kolbenverlängerung 50mm Ram Extension 50mm	7-16	801 806	Antriebswellen Stecknuss Satz 3/4" Drive shaft socket kit 3/4"	1-32 8-41
609 215	10 to. Hydraulik-Einheit 10 to. hydraulic unit	2-39	650 700-7	Abzieharm 100mm Standard Leg 100mm	7-16	805 024	XL-Impact Rohrstecknuss SW24 XL-impact socket SW24	1-32 8-41
609 310	Universal Pressrahmen inkl. Hydraulik Zylinder 10 ton. Universal base frame incl. 10 ton. hydraulic cylinder	2-38	650 700-8	Abzieharm 150mm Puller Leg 150mm	7-16	805 027	XL-Impact Rohrstecknuss SW27 XL-impact socket SW27	1-32 8-41
			650 700-9	Abzieharm 200mm Puller Leg 200mm	7-16	805 030	XL-Impact Rohrstecknuss SW30 XL-impact socket SW30	1-32 8-41
			651 001	Einsetzwerkzeug für Zünd- und Glühkerzen Spark and Glow Plug Starter	4-23	805 032	XL-Impact Rohrstecknuss SW32 XL-impact socket SW32	1-32 8-41



# INDEX

806 038	Stecknuss für Hydraulik Kupplungen SW38 x 1/2" Special socket for hydraulic couplings SW38 x 1/2"	8-42	905 003/TX	Umsteck-Schraubendreher, mit Einsatz TX 10/15 - 20/25 Screwdriver twin end TX, bit TX 10/15 - 20/25	7-23	EQ-294 112	1/2" XS Schlagschrauber, extra kurz 1/2" XS Impact Wrench, Ultra Short	1-12 3-05
807 003	Schlag-Verlängerung 125mm x 1/2" mit Verriegelung Impact locking extension 125mm x 1/2"	1-32 3-37 8-42	905 003/XZN	Umsteck-Schraubendreher, mit Einsatz XZN M4/M5 - M6/M8 Screwdriver twin end XZN, bit XZN M4/M5 - M6/M8	7-23	EQ-294	1/2" Müller Schlagschrauber, 80Nm/8bar	1-13
807 004	Schlag-Verlängerung 250mm x 1/2" mit Verriegelung Impact locking extension 250mm x 1/2"	1-32 3-37 8-42	905 007/	Magnetschalen-Satz, 2-teilig, dunkelblau Magnetic Parts Bowl, 2 pcs., darkblue	7-08	114/80er	1/2" Mueller impact gun, 80Nm/8bar	3-05
807 020	Schlag-Verlängerungs-Satz Impact locking extension kit	1-32 3-37 8-42	905 007/gray	Magnetschalen-Satz, 2-teilig, grau Magnetic Parts Bowl, 2 pcs., gray	7-08	EQ-294 214	MÜLLER 214 1/2" Druckluftknarre MUELLER 214 1/2" Air Ratchet	1-17 8-14
809 200	Bitverlängerung 5/16" x 200mm Bit extension 5/16" x 200mm	7-11	905 007/neon	Magnetschalen-Satz, 2-teilig, neon Magnetic Parts Bowl, 2 pcs., neon	7-08	EQ-294 215	MÜLLER 215 3/8" Druckluftknarre MUELLER 215 3/8" Air Ratchet	1-17 8-14
810 203	Polygon-Impact Gelenk Satz 3-tlg. Polygon Impact Joint Kit 3pcs.	1-33 3-37 7-22	905 007/orange	Magnetschalen-Satz, 2-teilig, orange Magnetic Parts Bowl, 2 pcs., orange	7-08	EQ-294 216	MÜLLER 216 1/4" Druckluftknarre MUELLER 216 1/4" Air Ratchet	1-17 8-14
810 303	Kraft-Kugelenk-Stecknuss-Satz, 3-tlg. SW21, 22, 24 x 1/2" Impact ball joint socket kit, 3pcs. 21, 22, 24mm x 1/2"	7-23 8-43	905 018	Ratschen Spannleine bis 25 kg Ratchet-Rope up to 25 kg	3-39	EQ-294 217	MÜLLER 217 3/8" Druckluftknarre MUELLER 217 3/8" Air Ratchet	1-17 8-14
810 500/9	IMPACT Gelenkwellen 12-KantSatz, 9-tlg. IMPACT Axle shaft 12-point-kit, 9 pcs.	1-33 2-59 8-42	905 019	Ratschen Spannleine bis 40 kg Ratchet-Rope up to 40 kg	3-39	EQ-300 014	Hydraulik-Handpumpe 700 bar Hydraulic pump 700 bar	2-61 8-35 9-03
810 689	Kraft-Kugelenk-Stecknuss-Satz, 4-tlg. SW16, 17, 18, 19 x 1/2" Impact ball joint socket kit, 4pcs. 16, 17, 18, 19mm x 1/2"	3-38 7-23 8-43	905 024	Uni-Hakensatz, biegsam / universell anpassbar Uni-Hook-Kit, bendable / universally adjustable	3-40 7-26	EQ-320	Hydraulik-Set 20 to. Hydraulic-set 20 to.	9-02
810 700	XS-Stubby Impact Satz extra kurz, Antrieb 1/2" 10-24mm auf Leiste XS-Stubby Impact socket kit 10-24mm on rail	1-12 1-34 3-37 8-43	905 024	Uni-Hakensatz, starr Uni-Hook-Kit, inflexible	3-40 7-26	EQ-320/420	Druck- und Zughülzensatz + 20 to. Hydraulik-Set Press & Pull Sleeve Kit + Hydraulic-set 20 to.	2-61 8-36 9-03
810 808	Stecknuss-Satz XZN-Impact, 8-tlg. Socket kit XZN-impact 8 pcs.	1-34 2-59 8-43 8-44	905 070	Industrie-Universalschere mit Kabelschneider Mueller heavy duty scissor with cable cutter	7-25	EQ-320/700	Hydraulik-Set pneumatisch 20 to. Hydraulic-set with pneumatic pump 20 to.	2-61 8-36 9-03
826 000	Motor-Durchdrehvorrichtung 12 Zylinder Engine turning tool 12 cylinder	8-44	905 080	Industrie-Universalschere Mueller heavy duty scissor	7-25	EQ-370	Werkstatt-Service-Wagen Garage service cart	6-38 8-47 9-05
826 002	Motor-Durchdrehvorrichtung Engine turning tool	8-44	906 002	Stahlknetmasse ca. 50g, 24 Stk. Epoxy putty 50g, 24pcs.	7-25	EQ-371	Druck- und Zughülzensatz im Werkstatt-Service Wagen Press and pull sleeve kit in Garage service cart	2-62 9-05
839 001	Kunststoffrohrschneider PVC-hose cutter	8-44	906 002/1	Stahlknetmasse ca. 50g Epoxy putty 50g	7-25	EQ-376	Werkzeugwagen Toolbox	9-06
839 101	Ersatzmesser für Kunststoffrohrschneider Blade for PVC-hose cutter	8-44	906 023	Druckluft-Wartungsskit Air tool service kit	1-34	EQ-401 001	Schweißpunkt-Löser "VARIO-drill" Air spotwelding drill "VARIO-drill"	1-03 5-09 6-04
839 210	Spezial-Klemmgripzange Typ 1 Special locking plier type 1	8-44	CHA-307	Bremsen Zange Brake plier	3-21 7-02	EQ-404	Schweißpunkt-Löser "Spotite" Air spotwelding drill "Spotite"	1-03 5-09 6-04
839 220	Spezial-Klemmgripzange Typ 2 Special locking plier type 2	8-44	CHA-410/414	Spurstangen-Zangensatz, 2-tlg. Tie rod plier kit, 2 pcs.	2-33 7-02	EQ-432 015/ Sprinter	Radlager-Montage-Werkzeug Wheel Bearing Mounting Kit	2-14
839 230	Spezial-Klemmgripzange Typ 3 Special locking plier type 3	8-44	CHA-420	US-Wasserpumpenzange 240mm Plier 240mm	8-21	EQ-432 037	Radlager-Abdrucksatz VW-Gruppe Wheel bearing pull kit VW-group	2-17
841 001	Messingdom 20x300mm Brass mounting punch 20x300mm	8-45	CHA-421	US-Wasserpumpenzange 240mm Plier 240mm	7-03	EQ-500T	Teleskop-Getriebeheber 500kg Telescopic transmission jack 500 kg	9-07
841 030	Alu-Dorn 30x300mm Aluminium mounting punch 30x300mm	8-45	CHA-424	US-Wasserpumpenzange 114mm Plier 114mm	7-03	EQ-500T/G	Uni-2-Achs Schwenkplatte Uni-2-axis swivel head	9-07
842 005	LKW-Durchschlag-Satz 4-tlg. Heavy duty cone punch kit	8-45	CHA-426	US-Wasserpumpenzange 165mm Plier 165mm	7-03 8-21	EQ-500T/H-0	Teleskop-Getriebeheber 500kg Telescopic transmission jack 500 kg	9-07
843 200	Flachmeißel-Satz, 2-tlg. Heavy duty chisel kit, 2 pcs.	8-45	CHA-440	US-Wasserpumpenzange 300mm Plier 300mm	7-03 8-21	EQ-500T-A	Adapter für VAG-Motorenaufnahme Adapter for VAG-engines	9-07
860 015	Kraft-Vervielfältiger 1:5 Torque-multiplier 1:5	8-46	CHA-444	Universal Zange, 300mm Universal plier, 300mm	7-03	EQ-510 012	Universal-Motor-Stütztraverse Universal engine support	4-08
860 035	Universal Achsmutter-Schlüssel Uni axle nut wrench	8-46	CHA-447	US-Seitenschneider 200mm Cutting Plier 200mm	7-03 8-21	EQ-510 013	Universal-Motor-Stützvorrichtung Universal engine support	4-08
860 050	LKW Lagerschalen-Montagesatz Truck bearing ring mounting kit	8-47	CHA-449	US-Seitenschneider 250mm Cutting Plier 250mm	7-03 8-21	EQ-510 050	Universal Grubenbrücke inkl. Sicherheitsgelenker Truck pit bridge rail type, with handrail	8-23 9-11
860 050/E	Backensatz, 7-tlg. 7-part jaw set	8-47	CHA-460	US-Wasserpumpenzange 420mm Plier 420mm	7-03 8-21	EQ-510 050/ BE	Universal Grubenbrücke, bodeneben, inkl. Sicherheitsgelenker Truck pit bridge with handrail, flat type	8-22 9-10
902 382	Achsölwanne Satz, 2-tlg. Axle Oil Drain Pan Kit, 2-pcs.	8-48	CHA-480	US-Wasserpumpenzange 510mm Plier 510mm	7-03 8-21	EQ-510 050/ BEG	Universal Grubenbrücke, bodeneben, ohne Sicherheitsgelenker Truck pit bridge no handrail, flat type	8-22 9-10
902 390	Kühlwasser-Auffangwanne Oil Drain Pan	7-25 8-47	CHA-926	Sicherungsringzange für Ringe ab ca. 4 - 25mm Retaining Ring Plier for rings from approx. 4 - 25mm	7-04	EQ-510 050/G	Universal Grubenbrücke, ohne Sicherheitsgelenker Truck pit bridge rail type, no handrail	8-23 9-11
904 996	LED-Duo Werkstattlampe / Ladevorgang kabellos LED-DUO Lamp / Wireless Charger	7-26	CHA-927	Sicherungsringzange für Ringe bis 50mm Retaining Ring Plier for rings up to 50mm	7-04	EQ-510 050/S	Sicherheitsgelenker-Satz Handrail	8-22 8-23 9-10 9-11
905 000/10	Knie-Schutzkissen Pack, 10 Stk. Knee protection-pad, 10pcs.	3-38 7-24 8-48	CHA-929	Sicherungsringzange für Ringe bis 100mm mit Ratschen- / Feststellfunktion Retaining Ring Plier for rings up to 100mm with ratchet / lock mechanism	7-04	EQ-531	Drehmo-Tester für die KFZ-Werkstatt Workshop torque wrench tester	9-08
905 000/3	Knie-Schutzkissen Pack, 3 Stk. Knee protection-pad, 3 pcs.	3-38 7-24 8-48	CHA-RT-3	Universal Sicherungsring Zangen Satz, 3 Zangen + 15 Satz Greifspitzen Convertible retaining ring plier kit	7-04	EQ-609 710	Integral-Hydraulikspindel 10to. Combined Hydraulic Spindle 10 tons.	2-53 8-37
905 001	Arbeits-Schutzmatte Work protection mat	7-24 8-48	EQ-0205	Sortimentsbox Workshop box	5-03	EQ-609 710/3	Integral-Hydraulikspindel 3er Pack Combined Hydraulic spindles, pack of 3	2-53 8-37
905 001/2	Arbeits-Schutzmatte, 2 Stk. Work protection mat, 2 pcs.	7-24 8-48	EQ-113	Akku-Schlagschrauber 1/4" Cordless Impact Gun 1/4"	1-02	EQ-700	Pneumatik / Hydraulik-Einheit 700 bar Pneumatic-hydraulic unit 700 bar	2-61 8-35 9-03
905 003	Umsteck-Schraubendreher, mit Einsatz Kreuz PH 1 +2, Schlitz 3,0+5,5mm Screwdriver twin end, bit phillips PH 1 +2, slotted 3,0+5,5mm	7-23	EQ-114	Müller 114 Akku Schlagschrauber 1/2" Mueller 114 cordless Impact Gun 1/2"	1-02	EQ-727 050	UNI-Schnellstart- und Ladegerät UNI Power Pack and Booster	9-08
			EQ-1251	Radheber Wheel lifter	3-39 9-12	EQ-727 100	Universal Leckage-Sucher LS07 Leakage diagnostic unit LS07	9-12
			EQ-230	Induktionserhitzer Induction-Heater	9-09			
			EQ-290 480	LKW-Reifenabdrücker Tyre Pusher	8-10			

## ALLGEMEINE GESCHÄFTSBEDINGUNGEN

### § 1 Geltungsbereich

1. Unsere Verkaufsbedingungen gelten ausschließlich; entgegenstehende oder von unseren allgemeinen Geschäftsbedingungen abweichende Bedingungen des Kunden erkennen wir nicht an, es sei denn, wir hätten ausdrücklich schriftlich ihrer Geltung zugestimmt. Unsere Verkaufsbedingungen gelten auch dann, wenn wir in Kenntnis entgegenstehender oder von unseren allgemeinen Geschäftsbedingungen abweichender Bedingungen des Kunden die Lieferung an den Kunden vorbehaltslos ausführen.
2. Diese Angebote richten sich ausschließlich an Unternehmer (gewerbliche Nutzer) bzw. Händler. Kein Verkauf an Verbraucher/Endkunden, sprich Privatpersonen i.S.d. § 13 BGB.

### § 2 Angebot

1. Ist die Bestellung als Angebot gemäß § 145 BGB zu qualifizieren, so können wir dieses inner halb von 2 Wochen annehmen.
2. An Abbildungen, Zeichnungen, Kalkulationen und sonstigen Unterlagen behalten wir uns Eigentums- und Urheberrechte vor. Dies gilt auch für solche schriftlichen Unterlagen, die als „vertraulich“ bezeichnet sind. Vor ihrer Weitergabe an Dritte bedarf der Kunde unserer ausdrücklichen schriftlichen Zustimmung. Abbildungen können von Artikeln abweichen.
3. Der Mindestbestellwert für Wiederverkäufer beträgt 50,00 Euro.
4. Konstruktionsbedingte Änderungen behalten wir uns ohne vorherige Benachrichtigung vor.
5. Für Artikelnummern, die mit EQ beginnen, gelten gesonderte Konditionen.

### § 3 Zahlungsbedingungen

1. Sofern sich aus der Auftragsbestätigung nichts anderes ergibt, gelten unsere Preise „ab Lager Küps“, ausschließlich Verpackung; diese wird gesondert in Rechnung gestellt.
2. Die gesetzliche Mehrwertsteuer ist nicht in unseren Preisen eingeschlossen; sie wird in gesetzlicher Höhe am Tag der Rechnungsstellung in der Rechnung gesondert ausgewiesen.
3. Rechnungen und Lieferungen sind innerhalb von 10 Tagen nach Rechnungsdatum rein netto zu zahlen.
4. Es gelten die gesetzlichen Regeln betreffend die Folgen des Zahlungsverzugs.
5. Aufrechnungsrechte stehen dem Kunden nicht zu.
6. Vertreter sind zum Inkasso von Rechnungen nicht berechtigt.

### § 4 Lieferzeit und Annahmeverzug

1. Der Beginn der von uns angegebenen Lieferzeit setzt die Abklärung aller technischen Fragen voraus.
2. Die Einhaltung unserer Lieferverpflichtung setzt weiter die rechtzeitige und ordnungsgemäße Erfüllung der Verpflichtung des Kunden voraus. Die Einrede des nicht erfüllten Vertrages bleibt vorbehalten.
3. Kommt der Kunde in Annahmeverzug oder verletzt er schuldhaft sonstige Mitwirkungs-pflichten, so sind wir berechtigt, den uns insoweit entstehenden Schaden, einschließlich etwaiger Mehraufwendungen ersetzt zu verlangen. Weitergehende Ansprüche bleiben vorbehalten.
4. Sofern die Voraussetzungen von Abs. 3. vorliegen, geht die Gefahr eines zufälligen Untergangs oder einer zufälligen Verschlechterung der Kaufsache in dem Zeitpunkt auf den Kunden über, in dem dieser in Annahmeverzug geraten ist.

### § 5 Gefahrenübergang - Verpackungskosten

1. Sofern sich aus der Auftragsbestätigung nichts anderes ergibt, ist Lieferung „ab Lager Küps“, vereinbart.
2. Für die Rücknahme von Verpackungen gelten gesonderte Vereinbarungen.
3. Sofern der Kunde es wünscht, werden wir die Lieferung durch eine Transportversicherung eindecken; die insoweit anfallenden Kosten trägt der Kunde.
4. Ab 100,00 Euro Warenwert erfolgt die Lieferung verpackungs- und portofrei. Ausgenommen hiervon sind Warenlieferungen mit einem Gesamtgewicht von über 30 kg und Lieferungen an Wiederverkäufer.

### § 6 Mängelhaftung und Rücksendungen

1. Mängelansprüche des Kunden setzen voraus, dass dieser seinen nach § 377 HGB geschuldeten Untersuchungs- und Rügeobliegenheiten ordnungsgemäß nachgekommen ist.
2. Mängelrügen sind für uns nur dann beachtlich, wenn sie bis zum achten Tage nach Empfang der Ware durch den Käufer bei uns eingegangen sind.
3. Wir haften nach den gesetzlichen Bestimmungen, sofern der Kunde Schadensersatzansprüche geltend macht, die auf Vorsatz oder grober Fahrlässigkeit, einschließlich von Vorsatz oder grober Fahrlässigkeit unserer Vertreter oder Erfüllungsgehilfen beruhen. Soweit uns keine vorsätzliche Vertragsverletzung angelastet wird, ist die Schadensersatzhaftung auf den vorhersehbaren, typischerweise eintretenden Schaden begrenzt.
4. Wir haften nach den gesetzlichen Bestimmungen, sofern wir schuldhaft eine wesentliche Vertragspflicht verletzen; in diesem Fall ist aber die Schadensersatzhaftung auf den vorhersehbaren, typischerweise eintretenden Schaden begrenzt.
5. Die Haftung wegen schuldhafter Verletzung des Lebens, des Körpers oder der Gesundheit bleibt unberührt; dies gilt auch für die zwingende Haftung nach dem Produkthaftungsgesetz.
6. Soweit nicht vorstehend etwas Abweichendes geregelt, ist die Haftung abgeschlossen.
7. Die Verjährungsfrist für Mängelansprüche beträgt 12 Monate, gerechnet ab Gefahrenübergang.
8. Rücksendungen (Retouren) müssen grundsätzlich frei Haus abgefertigt werden. Unfreie Rücksendungen gehen annahmeverweigert an den Absender zurück.

### § 7 Gesamthaftung

1. Eine weitergehende Haftung auf Schadensersatz als in § 6 vorgesehen, ist - ohne Rücksicht auf die Rechtsnatur des geltend gemachten Anspruchs - ausgeschlossen. Dies

gilt insbesondere für Schadensersatzansprüche aus Verschulden bei Vertragsabschluss, wegen sonstiger Pflichtverletzungen oder wegen deliktischer Ansprüche auf Ersatz von Sachschäden gemäß § 823 BGB.

2. Die Begrenzung nach Abs. 1. gilt auch, soweit der Kunde anstelle eines Anspruchs auf Ersatz des Schadens, statt der Leistung Ersatz nutzloser Aufwendungen verlangt.
3. Soweit die Schadensersatzhaftung uns gegenüber ausgeschlossen oder eingeschränkt ist, gilt dies auch im Hinblick auf die persönliche Schadensersatzhaftung unserer Angestellten, Arbeitnehmer, Mitarbeiter, Vertreter und Erfüllungshilfen.

### § 8 Eigentumsvorbehaltssicherung

1. Wir behalten uns das Eigentum an der Kaufsache bis zum Eingang aller Zahlungen aus dem Liefervertrag vor. Bei vertragswidrigem Verhalten des Kunden, insbesondere bei Zahlungsverzug, sind wir berechtigt, die Kaufsache zurückzunehmen. In der Zurücknahme der Kaufsache durch uns liegt ein Rücktritt vom Vertrag. Wir sind nach Rücknahme der Kaufsache zu deren Verwertung befugt, der Verwertungserlös ist auf die Verbindlichkeiten des Kunden - abzüglich angemessener Verwertungskosten - anzurechnen.
2. Der Kunde ist verpflichtet, die Kaufsache pfleglich zu behandeln.
3. Bei Pfändungen oder sonstigen Eingriffen Dritter hat uns der Kunde unverzüglich schriftlich zu benachrichtigen, damit wir Klage gemäß § 771 ZPO erheben können. Soweit der Dritte nicht in der Lage ist, uns die gerichtlichen und außergerichtlichen Kosten einer Klage gemäß § 771 ZPO zu erstatten, haftet der Kunde für den uns entstandenen Ausfall.
4. Der Kunde ist berechtigt, die Kaufsache im ordentlichen Geschäftsgang weiter zu verkaufen; er tritt uns jedoch bereits jetzt alle Forderungen in Höhe des Faktura-Endbetrages (einschließlich MwSt) unserer Forderung ab, die ihm aus der Weiterveräußerung gegen seine Abnehmer oder Dritte erwachsen, und zwar unabhängig davon, ob die Kaufsache ohne oder nach Verarbeitung weiter verkauft worden ist. Zur Einziehung dieser Forderung bleibt der Kunde auch nach der Abtretung ermächtigt. Unsere Befugnis, die Forderung selbst einzuziehen, bleibt hiervon unberührt. Wir verpflichten uns jedoch, die Forderung nicht einzuziehen, solange der Kunde seinen Zahlungsverpflichtungen aus den vereinnahmten Erlösen nachkommt, nicht in Zahlungsverzug gerät und insbesondere kein Antrag auf Eröffnung eines Vergleichs- oder Insolvenzverfahrens gestellt ist oder Zahlungseinstellung vorliegt. Ist aber dies der Fall, so können wir verlangen, dass der Kunde uns die abgetretenen Forderungen und deren Schuldner bekannt gibt, alle zum Einzug erforderlichen Angaben macht, die dazugehörigen Unterlagen aushändigt und den Schuldner (Dritten) die Abtretung mitteilt.
5. Die Verarbeitung oder Umbildung der Kaufsache durch den Kunden wird stets für uns vorgenommen. Wird die Kaufsache mit anderen, uns nicht gehörenden Gegenständen verarbeitet, so erwerben wir das Miteigentum an der neuen Sache im Verhältnis des Wertes der Kaufsache (Fakturaendbetrag, einschließlich MWST) zu den anderen verarbeiteten Gegenständen zur Zeit der Verarbeitung. Für die durch Verarbeitung entstehende Sache gilt im Übrigen das Gleiche wie für die unter Vorbehalt gelieferte Kaufsache.
6. Wird die Kaufsache mit anderen, uns nicht gehörenden Gegenständen untrennbar vermischt, so erwerben wir das Miteigentum an der neuen Sache im Verhältnis des Wertes der Kaufsache (Fakturaendbetrag, einschließlich MWST) zu den anderen vermischten Gegenständen zum Zeitpunkt der Vermischung. Erfolgt die Vermischung in der Weise, dass die Sache des Kunden als Hauptsache anzusehen ist, so gilt als vereinbart, dass der Kunde uns anteilmäßig Miteigentum überträgt. Der Kunde verwahrt das so entstandene Alleineigentum oder Miteigentum für uns.
7. Der Kunde tritt uns auch die Forderungen zur Sicherheit unserer Forderungen gegen ihn ab, die durch die Verbindung der Kaufsache mit einem Grundstück gegen einen Dritten erwachsen.
8. Wir verpflichten uns, die uns zustehenden Sicherheiten auf Verlangen des Kunden insoweit freizugeben, als der realisierbare Wert unserer Sicherheiten die zu sichernden Forderungen um mehr als 10% übersteigt; die Auswahl der freizugebenden Sicherheiten obliegt uns.
9. Uns steht wegen der Forderung aus dem Auftrag ein vertragliches Pfandrecht an den aufgrund des Auftrags in unseren Besitz gelangten Gegenständen zu. Das vertragliche Pfandrecht kann auch wegen Forderungen aus früheren Lieferungen, Arbeiten und sonstigen Leistungen geltend gemacht werden, soweit sie mit dem Auftragsgegenstand in Zusammenhang stehen. Für sonstige Ansprüche aus der Geschäftsverbindung gilt das vertragliche Pfandrecht nur, soweit diese unbestritten sind oder ein rechtskräftiger Titel vorliegt und der Auftragsgegenstand dem Auftraggeber gehört.

### § 9 Sonstige Vereinbarungen

1. Mündliche Absprachen haben nur Gültigkeit, wenn sie von uns schriftlich bestätigt werden.
2. Lieferungen, die nicht aus unserem Produktkatalog stammt (Sonderbeschaffungen), sind von einer Rücknahme oder Umtausch ausdrücklich ausgeschlossen.
3. Bei Falschbestellung berechnen wir 15 % Rücknahme- / Bearbeitungsgebühr, jedoch mindestens 10,00 Euro netto.

### § 10 Gerichtsstand - Erfüllungsort

1. Sofern der Kunde Kaufmann ist, ist unser Geschäftssitz Gerichtsstand; wir sind jedoch berechtigt, den Kunden auch an seinem Wohnsitzgericht zu verklagen.
2. Es gilt das Recht der Bundesrepublik Deutschland; die Geltung des UN-Kaufrechts ist ausgeschlossen.
3. Sofern sich aus der Auftragsbestätigung nichts anderes ergibt, ist unser Geschäftssitz Erfüllungsort.

Rechtliche Bestimmungen: © 2019 Müller-Werkzeug GmbH & Co. KG  
 Alle Rechte vorbehalten. Nachdruck, Aufnahme in Online Dienste und Internet und Vervielfältigungen auf Datenträger wie z.B. CD-Rom, DVD, etc.. auch auszugsweise, nur nach vorheriger Zustimmung des Herausgebers. Konstruktionsbedingte Änderungen behalten wir uns ohne vorherige Benachrichtigung vor. Abbildungen können von Artikel abweichen.  
 Druckfehler, Irrtümer und Änderungen vorbehalten.  
 Fotos © by Fotostudio Wendler - www.fotostudiobewe.de





**MÜLLER-WERKZEUG** GmbH & Co KG

Flurstraße 13  
D-96215 Lichtenfels

Telefon: +49 (0) 95 71 / 169 87-0  
Fax: +49 (0) 95 71 / 169 87-99

info@mueller-werkzeug.de  
www.mueller-werkzeug.de



**MÜLLER-WERKZEUG** Benelux

Toepadweg 4  
NL-5301 KA Zaltbommel

Phone: +31 (0) 418 / 68 03 43  
Fax: +31 (0) 418 / 68 03 44

info@mueller-werkzeug.nl  
www.mueller-werkzeug.nl



**MUELLER-KUEPS** LP

2220 Northmont Parkway #250  
Duluth, GA 30096

Phone: +1 770 349 6331  
Fax: +1 678 417 6273

info@mueller-kueps.com  
www.mueller-kueps.com